

# EC/pH TRANSDUCER

## INSTALLATION AND OPERATION MANUAL

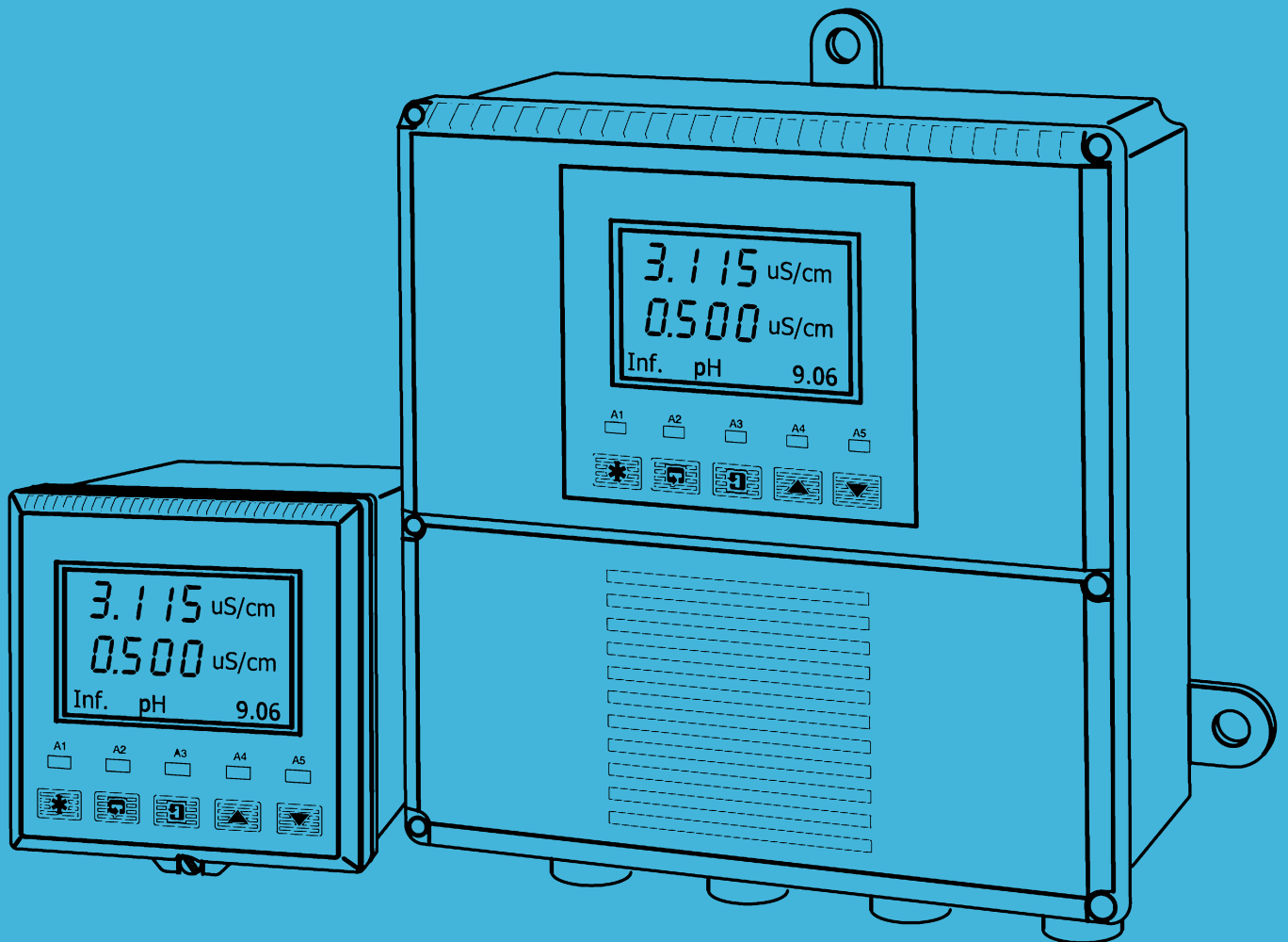

© COPYRIGHT 2012, NETAFIM

NO PARTS OF THIS PUBLICATION MAY BE REPRODUCED, STORED IN AN AUTOMATED DATA FILE OR MADE PUBLIC IN ANY FORM OR BY ANY MEANS, WHETHER ELECTRONIC, MECHANICAL, BY PHOTOCOPYING, RECORDING OR IN ANY OTHER MANNER WITHOUT PRIOR WRITTEN PERMISSION OF THE PUBLISHER.

ALTHOUGH NETAFIM TAKES THE GREATEST POSSIBLE CARE IN DESIGNING AND PRODUCING BOTH ITS PRODUCTS AND THE ASSOCIATED DOCUMENTATION, THEY MAY STILL INCLUDE FAULTS.

NETAFIM WILL NOT ACCEPT RESPONSIBILITY FOR DAMAGE RESULTING FROM THE USE OF NETAFIM'S PRODUCTS OR THE USE OF THIS MANUAL.

NETAFIM RESERVES THE RIGHT TO MAKE CHANGES AND IMPROVEMENTS TO ITS PRODUCTS AND/OR THE ASSOCIATED DOCUMENTATION WITHOUT PRIOR NOTICE.

# CONTENTS

## Introduction

Use of symbols in this Manual	4
Introduction	4
Electrical Safety	5
Use of symbols on the equipment Labelling	5
Health and Safety	5

## Operation

Powering Up the Analyzer	6
Interface Navigation Chart	7

## Setup

Sensor Calibration	8
EC Sensor Calibration	9
pH Sensor Calibration	11

## Installation

Siting Requirement	13
Dimensions	13
Mounting	14
Connections, General	15
Wall-/Pipe-mount Analyzer Connections	17
Panel-mount Analyzer Connections	19

## Maintenance, Simple Fault Finding

Maintenance Instructions	20
No Response to Conductivity Changes	20
Calibration Fail Message or No Response to pH/Redox Changes	20
Chemical treatment of pH sensor	20

## Spare Parts

Spare Parts Ordering Information	21
----------------------------------	----

## Specification

Mechanical Data	22
Power Supply	22
Environmental Data	22
EMC	22
Approvals, Certification and Safety	22
Laguages	22
Conductivity and pH	22
Sensor Specification	22

Warranty	23
----------	----

# INTRODUCTION

## Use of symbols in this manual

The symbols used in this manual refer to the following:



### WARNING

The following text contains instructions aimed at preventing bodily injury or direct damage to the crops, the product and/or the infrastructure.



### CAUTION

The following text contains instructions aimed at preventing unwanted system operation, installation or conditions that, if not followed, might void the warranty.



### ELECTRICAL HAZARD

The following text contains instructions aimed at preventing death or injury by electrocution or direct damage to the product and/or the infrastructure.



### NOTE

The following text contains instructions aimed at emphasizing certain aspect of the operation of the system or installation.

## Introduction

Dual input pH & Conductivity analyzers and associated electrode systems have been designed for continuous monitoring and control of pH and Conductivity. The electrode system can be standardized to the analyzer using the built-in calibration facility and a single point buffering facility provides easy re-calibration after initial standardization.

The analyzer is available in wall-/pipe-mount or panel-mount versions with either one or two programmable, pH & Conductivity input channels, each with its own associated temperature input channel. When making temperature compensated measurements, the sample temperature is sensed by a resistance thermometer Pt100 at Conductivity and Manual at PH measurement.

All models incorporate 2 output 4-20mA for PH & Conductivity, Conductivity range 0-10 mS, PH range 0-14 PH.

Analyzer operation and programming are performed using five tactile membrane keys on the front panel. Programmed functions are protected from unauthorized alteration by a four-digit security code.

EN ISO 9001:2000  
Cert. No. Q 05907



EN 29001 (ISO 9001)  
Lenno, Italy -  
Cert. No. 9/90A



Stonehouse, U.K.  
0255











# INTRODUCTION

## Electrical Safety

This equipment complies with the requirements of CEI/IEC 61010-1:2001-2 'Safety Requirements for Electrical Equipment for Measurement, Control and Laboratory Use'. If the equipment is used in a manner NOT specified by the Company, the protection provided by the equipment may be impaired.

## Use of symbols on the equipment labelling

One or more of the following symbols may appear on the equipment labelling:

	<b>Warning</b> - Refer to the manual for instructions		Direct current supply only
	<b>Caution</b> - Risk of electric shock		Alternating current supply only
	Protective earth (ground) terminal		Both direct and alternating current supply
	Earth (ground) terminal		The equipment is protected through double insulation

## Health and Safety

To ensure that our products are safe and without risk to health, the following points must be noted:

1. The relevant sections of these instructions must be read carefully before proceeding.
2. Warning labels on containers and packages must be observed.
3. Installation, operation, maintenance and servicing must only be carried out by suitably trained personnel and in accordance with the information given.
4. Normal safety precautions must be taken to avoid the possibility of an accident occurring when operating in conditions of high pressure and/or temperature.
5. Chemicals must be stored away from heat, protected from temperature extremes and powders kept dry. Normal safe handling procedures must be used.
6. When disposing of chemicals ensure that no two chemicals are mixed.

Safety advice concerning the use of the equipment described in this manual or any relevant hazard data sheets (where applicable) may be obtained from the Company address on the back cover, together with servicing and spares information.



### **DANGER**

**Hazard of electric shock, explosion, or arc flash.** Disconnect all power before servicing equipment.  
**Failure to follow these instructions will result in death or serious injury.**



### **CAUTION**

Only qualified electricians are permitted to perform electrical installations and repairs!

# OPERATION

## Powering Up the Analyzer



### WARNING

Warning. Ensure all connections are made correctly, especially to the earth stud (see pages 19-20).

1. Ensure the input sensors are connected correctly.
2. Switch on the power supply to the analyzer. A start-up screen is displayed while internal checks are performed.

## Displays and Controls

The display comprises two rows of 4 1/2 digit, 7-segment digital displays, which show the actual values of the measured parameters and alarm set points, and a 6-character dot matrix display showing the associated units. The lower display line is a 16-character dot matrix display showing the programming information.

### Location of Controls and Displays

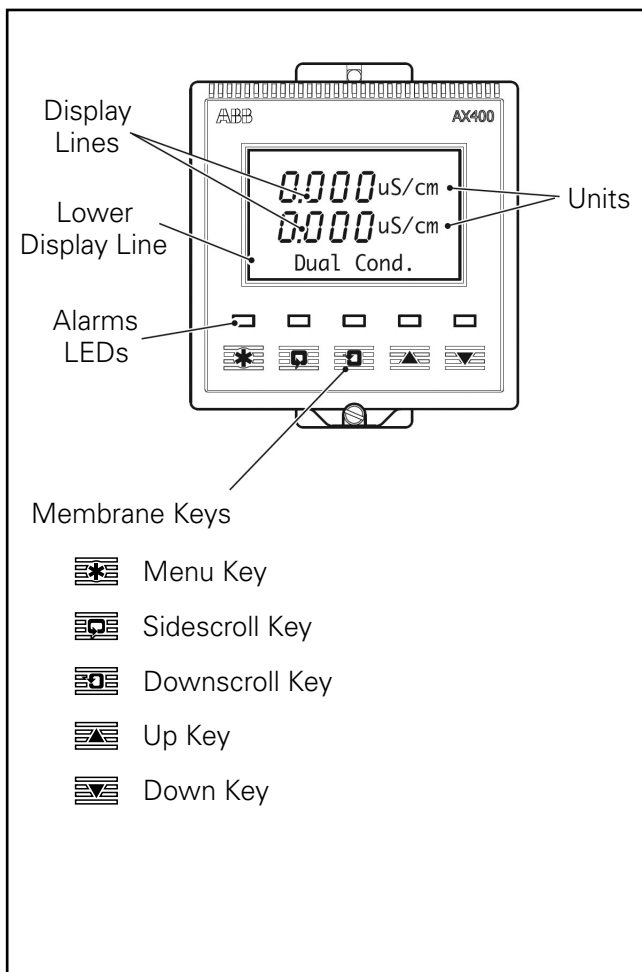

## Membrane Key Functions

### A - Moving Between Menus

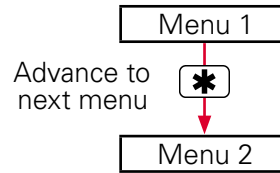

### B - Advancing to Next Page

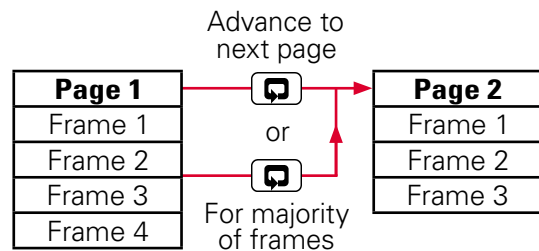

### C - Moving Between Frames

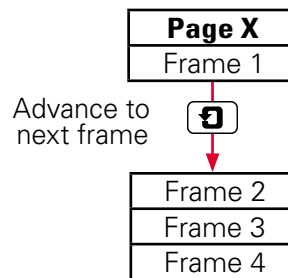

### D - Adjusting and Storing a Parameter Value

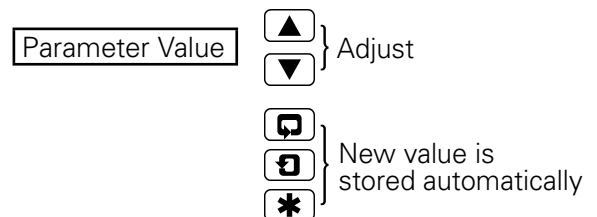

### E - Selecting and Storing a Parameter Choice

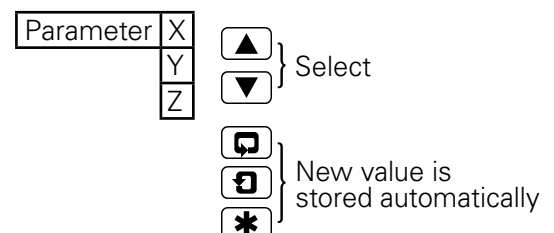

# OPERATION

## Interface Navigation Chart

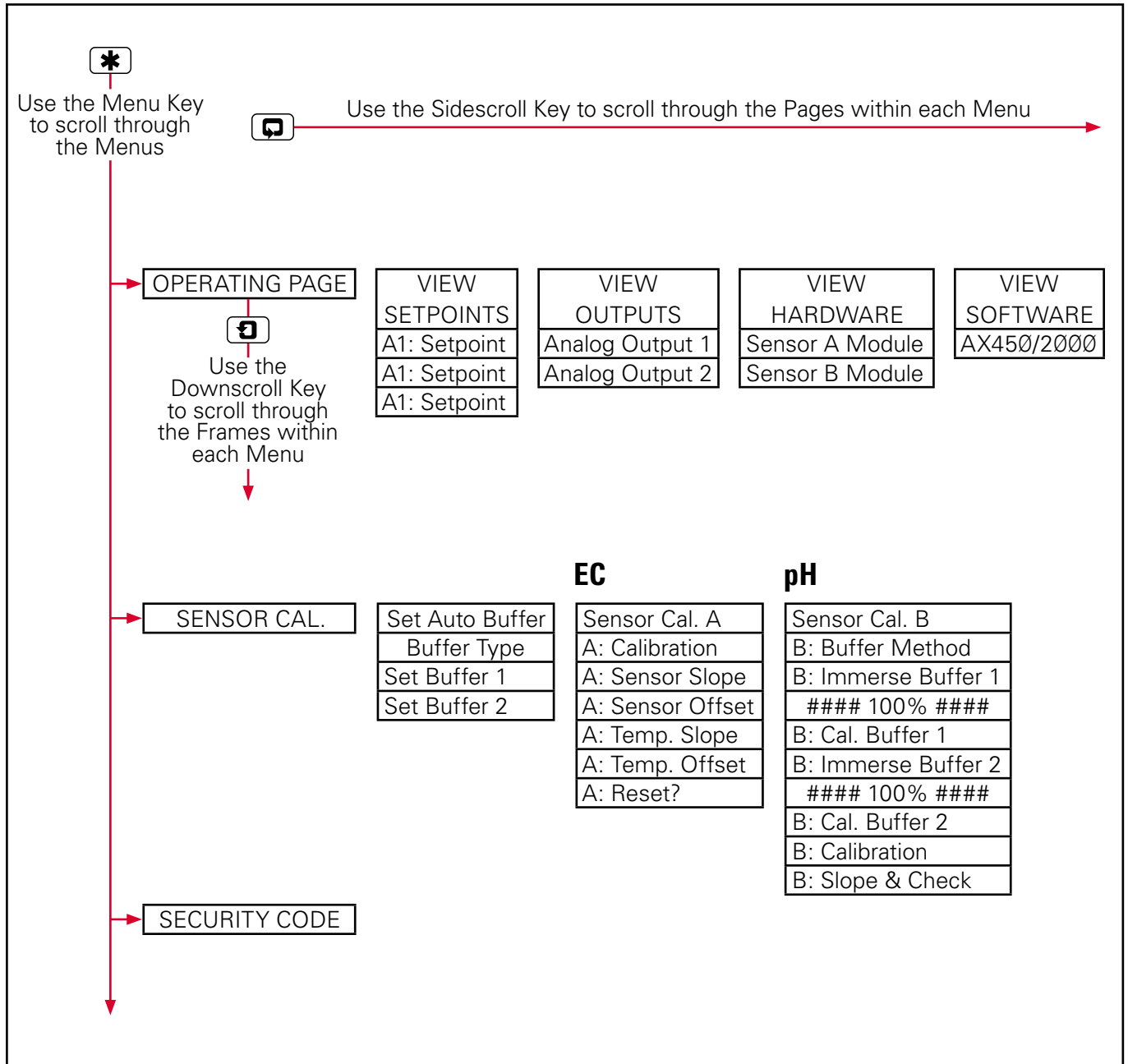

# SETUP

## Sensor Calibration

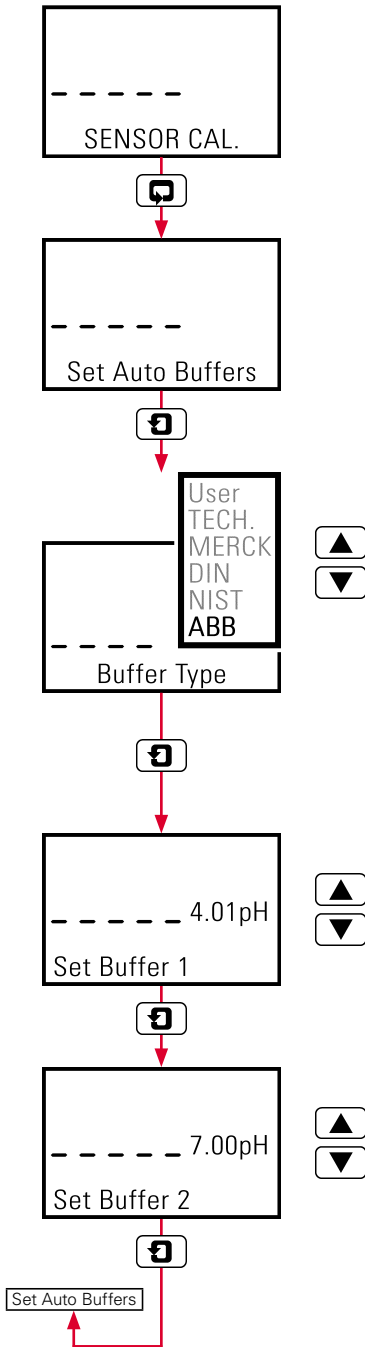

### Set Buffer Type (pH Only)

---

#### Set Auto Buffers

---

#### Buffer Type

Select the relevant type of buffer solution (see Appendix A):

- ABB** ABB supplied buffer solution.
- NIST** NIST buffer solution.
- DIN** DIN 19266 buffer solution.
- MERCK** MERCK buffer solution
- TECH** US Technical buffer solution
- User** Buffer solution with a user defined pH value -

---

#### Set Buffer 1

Set the pH value of the buffer 1 solution - see Appendix A for pH tables.

---

#### Set Buffer 2

Set the pH value of the buffer 2 solution.



#### NOTE

The solution selected for buffer 2 must be at least 2 pH greater than that selected for buffer 1, e.g. if buffer 1 is set to 7 pH, buffer 2 must be set to at least 9 pH.



# SETUP

## EC Sensor Calibration



### NOTE

- Sensor calibration is not usually required as the cell constant 'K' assigned to a cell is sufficiently accurate for most applications.
- TB2 cells are equipped with 2-wire temperature compensators therefore temperature errors can be expected in applications where the length of the connecting cable exceeds 10m. Carry out an in-situ temperature calibration to remove these errors.
- The analyzer is calibrated by the Company prior to dispatch and the Factory Settings pages are protected by an access code.

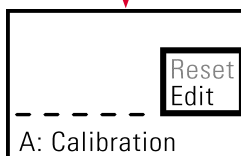
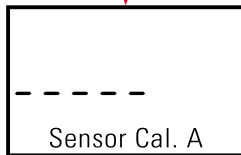
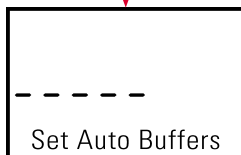
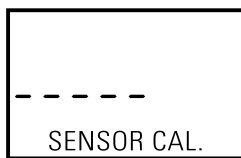

continued on next page

### Calibrate the Sensor

#### Edit or Reset Calibration

Select **Edit** to manually adjust the Slope values of the process and temperature sensors.

Select **Reset** to reset the sensor calibration data to the standard default settings:

Sensor Slope = 1.200

Temperature Slope = 1.000

Sensor and Temperature Offset = 0.0

Set to **Edit**

Immerse the EC sensor into Calibration Buffer 1413 for 30 seconds.



# SETUP

continued from  
previous page

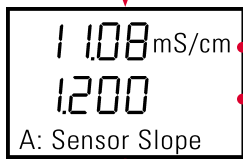

## Sensor Slope

Measured conductivity value.

Sensor slope value.

Use the and keys to adjust the sensor slope value within the range 0.200 to 5.000 until the measured conductivity value is correct.

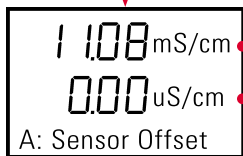

## Sensor Offset



### WARNING

Do not alter the values appearing on the screen.

Measured conductivity value.

Sensor offset value.



## Temperature Slope



### WARNING

Do not alter the values appearing on the screen unless you are sure the temperature reading is incorrect.

Measured temperature value.

Temperature slope value.

Use the and keys to adjust the temperature slope value within the range 0.200 to 1.500 until the measured temperature value is correct.

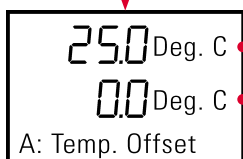

## Temperature Offset



### WARNING

Do not alter the values appearing on the screen.

Measured conductivity value.

Sensor offset value.

**A: Calibration**  
set to Reset

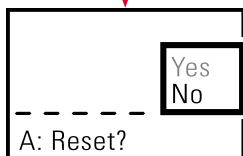

## Reset Calibration

Select **Yes** and press to reset the calibration data.

Select **No** and press to abort.



Sensor Cal. A

Return to top of page.

# SETUP

## pH Sensor Calibration

-----  
SENSOR CAL.



-----  
Set Auto Buffers



-----  
Sensor Cal. A



-----  
Sensor Cal. B



Auto  
-----  
2-Pt  
B: Buffer Method



4.00 pH  
25.0 Deg.C  
B: Immerse Buf. 1



175 mV  
#### 100% ####



4.01 pH  
B: Cal. Buffer 1

Immerse Buf. 2

### Automatic, Single- and Two-Point Calibration (pH Only)

#### Sensor A: Buffer Method (pH probes only)

Select the type of automatic calibration required:

**Auto 1-Pt** - Automatic, single-point calibration

**Auto 2-Pt** - Automatic, two-point calibration

#### Calibrate Buffer 1 (Two-Point Calibration)

Immerse Sensor A in the buffer solution.

Press the  key to initiate calibration.



#### NOTE

To abort calibration, press the  key again at any time before calibration is complete - see page 13.



The center display line shows the measured sensor output in millivolts.

As calibration proceeds, a progress indicator appears in the lower display line. When the measured sensor output stabilizes, the lower display line shows ##### 100 % #####.

The display then changes for 2 seconds to show the temperature-corrected buffer value in the upper display line, then advances automatically to the next frame.

Two-point calibration selected - continued on next page.

# SETUP

**A: Buffer Method**  
set to **Auto 2-Pt**

7.00 pH  
20.0 Deg.C  
B: Immerse Buf. 2



0 mV  
#### 100% ####

7.00 pH  
B: Cal. Buffer 2

----- Passed  
B: Calibration



100.0%  
7.00 pH  
B: Slope & Check

Sensor Cal. B



## Calibrate Buffer 2 (Two-Point Calibration only)

Immerse Sensor A in the second buffer solution.

Press the key to initiate calibration.



### NOTE

To abort calibration, press the key again at any time before calibration is complete - see page 13.



The center display line shows the measured sensor output in millivolts.

As calibration proceeds, a progress indicator appears in the lower display line. When the measured sensor output stabilizes, the lower display line shows ##### 100 % #####.

The display then changes for 2 seconds to show the temperature-corrected buffer value in the upper display line, then advances automatically to the next frame.

## Calibration Message

See Table below for details of calibration messages.

### Slope Value

% slope value.

A value between the programmed minimum 60% slope value and 105 % is displayed. If the value is outside these limits, check the electrode system (See Calibration Messages Table below).

pH check value.

Displayed as an additional indication of electrode system condition; 7 ph is the optimum value for glass electrodes and.

----- Yes  
B: Abort Cal.



### NOTE

To **Abort Calibration**, press the key again at any time before calibration is complete, and then select **Yes** or **No**.

A: SENSOR CAL.

**Yes** selected - return to the main menu.

A: Immerse Buf. 2

**No** selected - calibration continues.

## Calibration Messages

Calibration Message	Min.	Max.	Explanation	Action
Calibration Passed	60 %	105 %	The new calibration coefficients are accepted	None
Calibration Low Slope	60 to 90 %	60 to 90 %	The new calibration coefficients are accepted	The electrode pair are becoming fatigued - replacement is recommended
Calibration Failed	0%	60 %	The new calibration coefficients are ignored and the last known valid calibration coefficients are used	Check buffer values and repeat buffering. If the fault persists, replace the electrodes

# INSTALLATION

## Siting Requirements



### NOTE

- Mount in a location free from excessive vibration, and where the temperature and humidity specification will not be exceeded.
- Mount away from harmful vapors and/or dripping fluids and ensure that it is suitably protected from direct sunlight, rain, snow and hail.
- Where possible, mount the analyzer at eye level to allow an unrestricted view of the front panel displays and controls.

### A - Maximum Distance Between Analyzer and Sensor

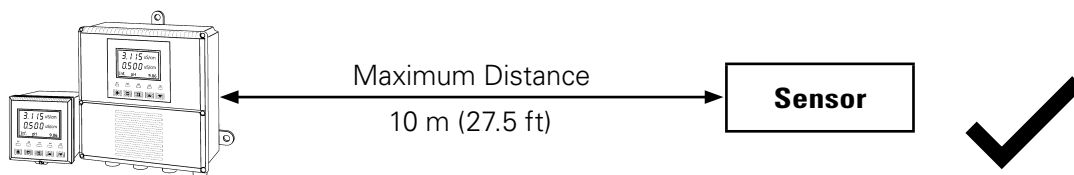

### B - Within Temperature Limits

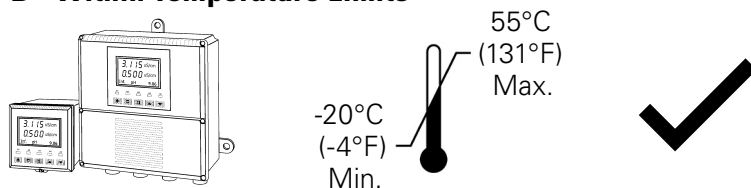

### C - Within Environmental Limits

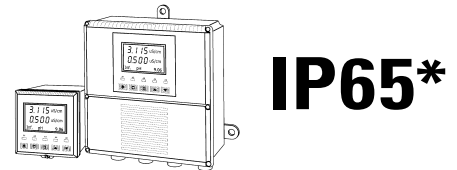

\* Refer to Specification, see page 22.

## Dimensions

### Wall-/Pipe-mount Analyzer

Overall Dimensions in mm (in.)

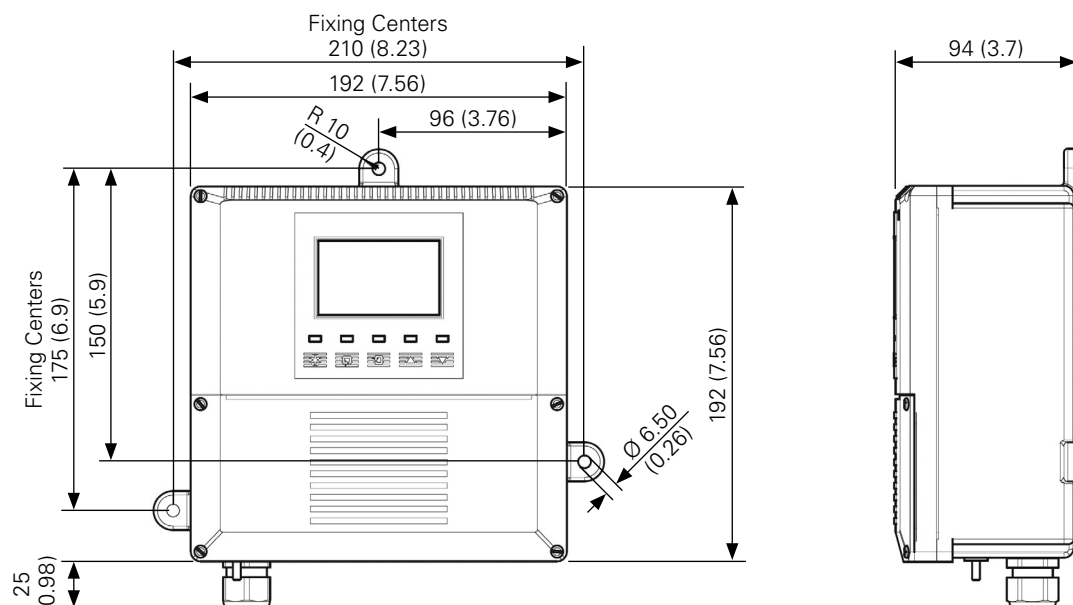

# INSTALLATION

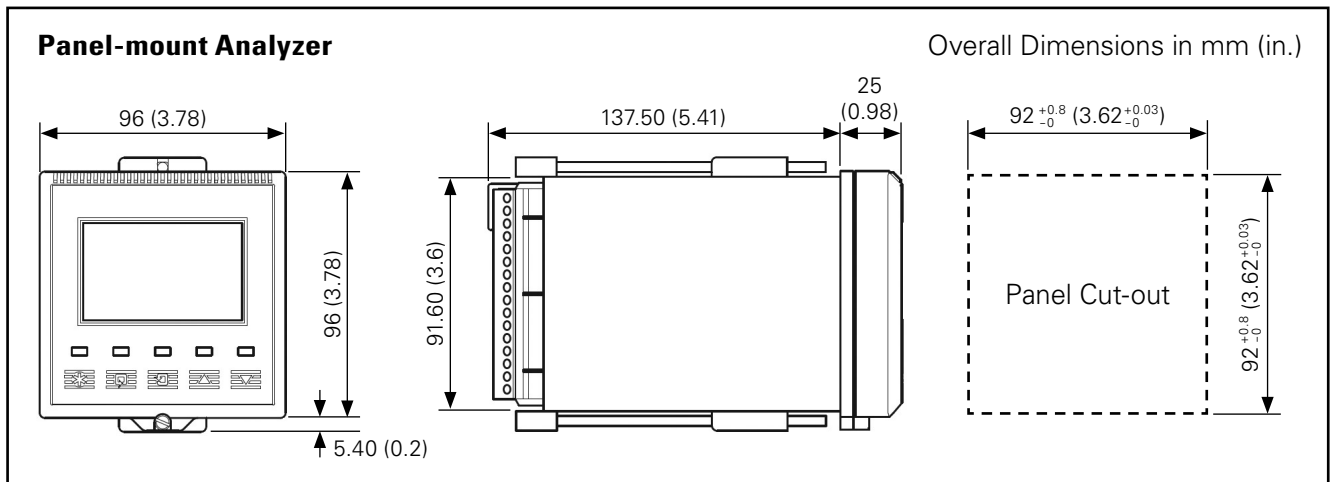

## Mounting

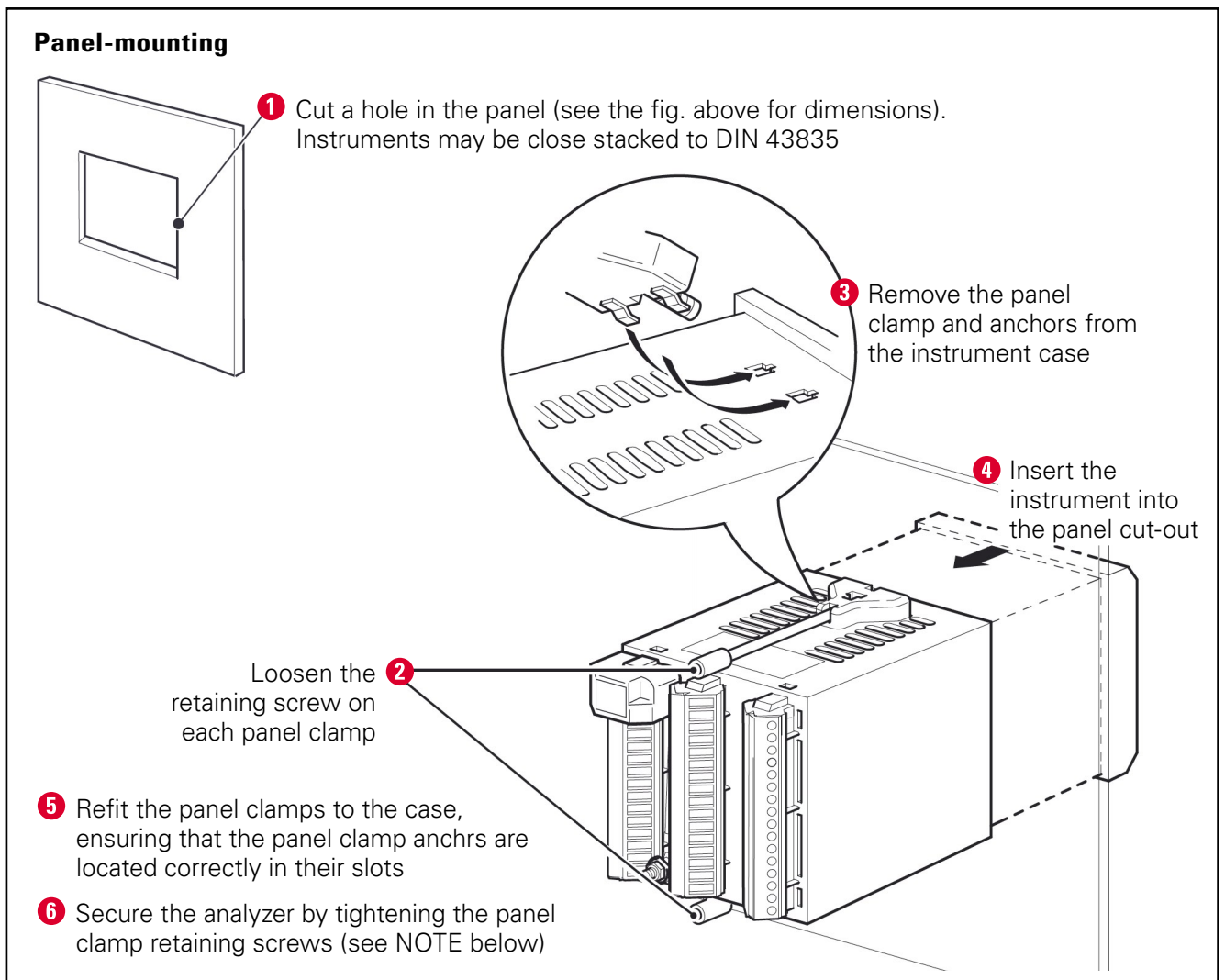

### NOTE

The clamp must fit flat on the analyzer casing. The clamp uses a torque limiter, so it is not possible to over-tighten the securing screws.

# INSTALLATION

## Connections, General



### WARNING

- The instrument is not fitted with a switch therefore a disconnecting device such as a switch or circuit breaker conforming to local safety standards must be fitted to the final installation. It must be fitted in close proximity to the instrument within easy reach of the operator and must be marked clearly as the disconnection device for the instrument.
- Remove all power from supply, relay and any powered control circuits and high common mode voltages before accessing or making any connections.
- The power supply earth (ground) must be connected to reduce the effects of RFI interference and ensure the correct operation of the power supply interference filter.
- The power supply earth (ground) must be connected to the earth (ground) stud on the analyzer case - see page 18 (wall-/pipe-mount analyzers) or page 19 (panel-mount analyzers).
- Use cable appropriate for the load currents. The terminals accept cables from 20 to 14 AWG (0.5 to 2.5mm<sup>2</sup>) UL Category AVLV2.
- The instrument conforms to Mains Power Input Insulation Category III. All other inputs and outputs conform to Category II.
- All connections to secondary circuits must have basic insulation.
- After installation, there must be no access to live parts, e.g. terminals.
- Terminals for external circuits are for use only with equipment with no accessible live parts.
- The relay contacts are voltage-free and must be appropriately connected in series with the power supply and the alarm/control device which they are to actuate. Ensure that the contact rating is not exceeded.
- Do not exceed the maximum load specification for the selected analog output range.  
The analog output is isolated, therefore the -ve terminal must be connected to earth (ground) if connecting to the isolated input of another device.
- If the instrument is used in a manner not specified by the Company, the protection provided by the equipment may be impaired.
- All equipment connected to the instrument's terminals must comply with local safety standards.

# INSTALLATION



## NOTE

- An earthing (grounding) - stud terminal is fitted to the analyzer case for bus-bar earth (ground) connection - see page 18 (wall-/pipe-mount analyzers) or page 19 (panel-mount analyzers).
- Always route signal output/sensor cell cable leads and mains-carrying/relay cables separately, ideally in earthed (grounded) metal conduit. Use twisted pair output leads or screened cable with the screen connected to the case earth (ground) stud.

Ensure that the cables enter the analyzer through the glands nearest the appropriate screw terminals and are short and direct. Do not tuck excess cable into the terminal compartment.

- Ensure that the IP65 rating is not compromised when using cable glands, conduit fittings and blanking plugs/bungs (M20 holes). The M20 glands accept cable of between 5 and 9mm (0.2 and 0.35 in.) diameter.

## Cable Entry Knockouts, Wall-/Pipe-mount Analyzer

The analyzer is supplied with 7 cable glands, one fitted and six to be fitted, as required, by the user.

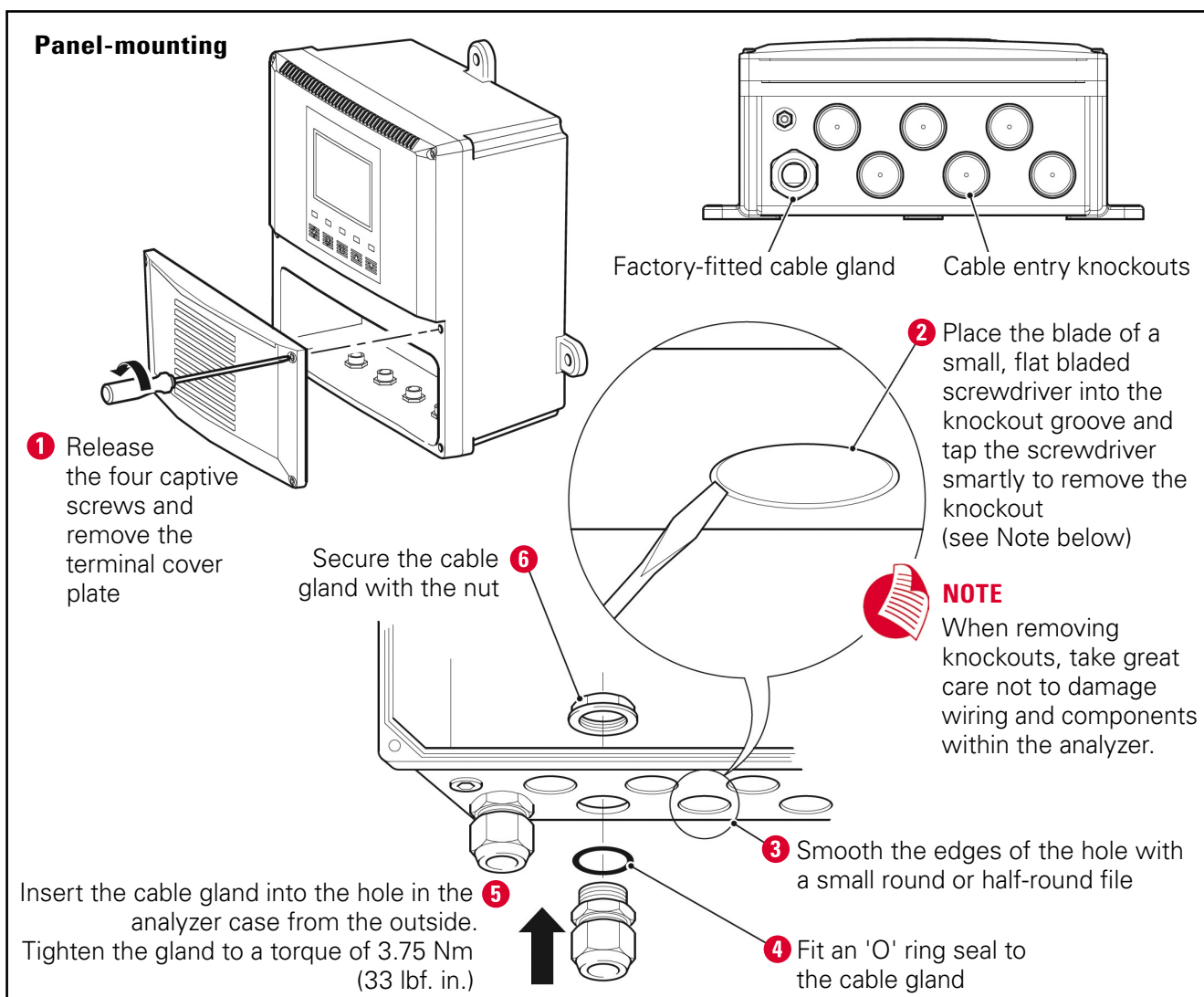

## NOTE

The cable glands must be tightened to a torque of 3.75 Nm (33 lbf. in.)



# INSTALLATION

## Wall-/Pipe-mount Analyzer Connections

### Access to Terminals

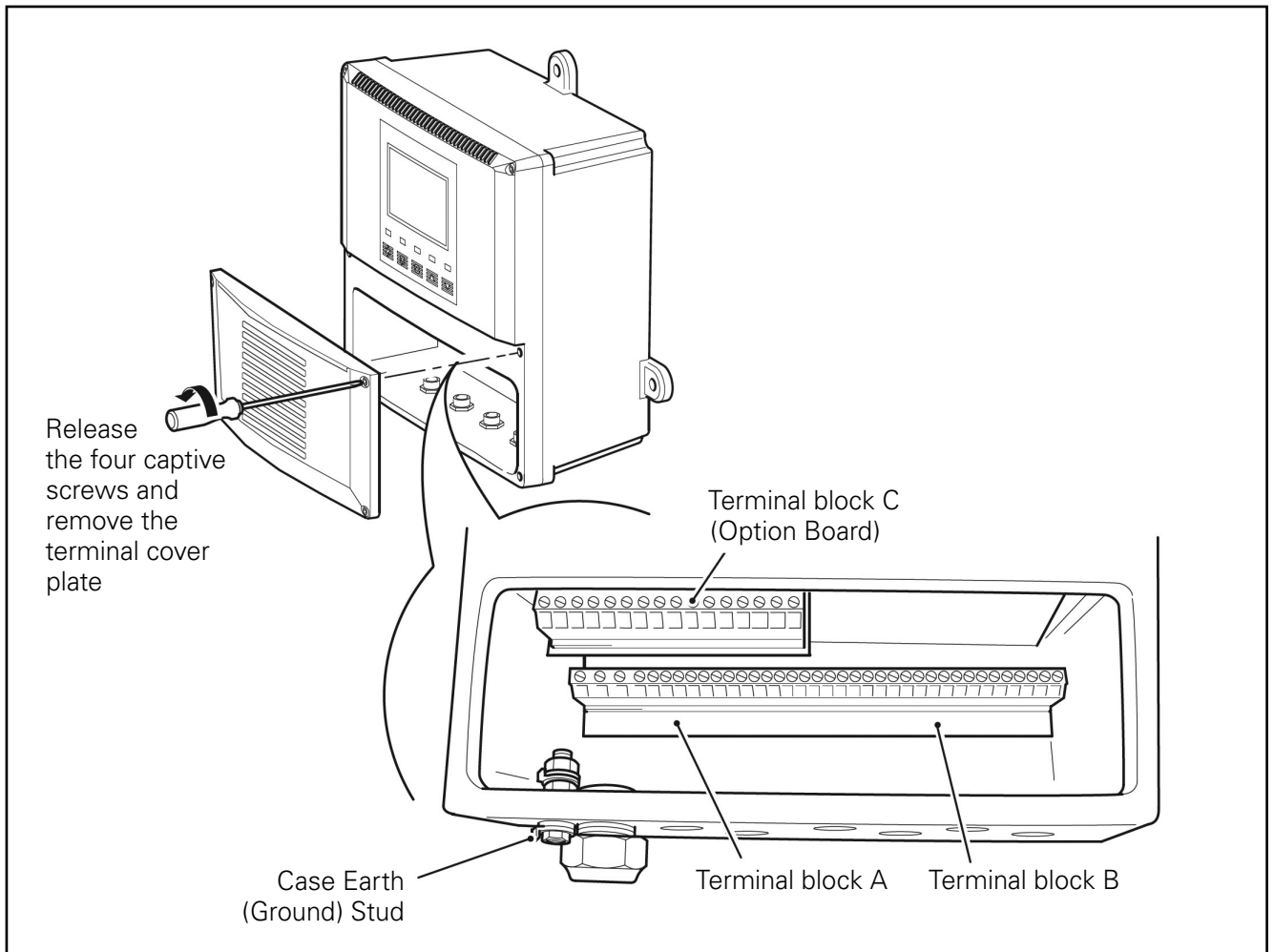

#### NOTE

When refitting the terminal cover plate, tighten the captive screws to a torque of 0.40 Nm (3.5 lbf. in.)

# INSTALLATION

## Connections

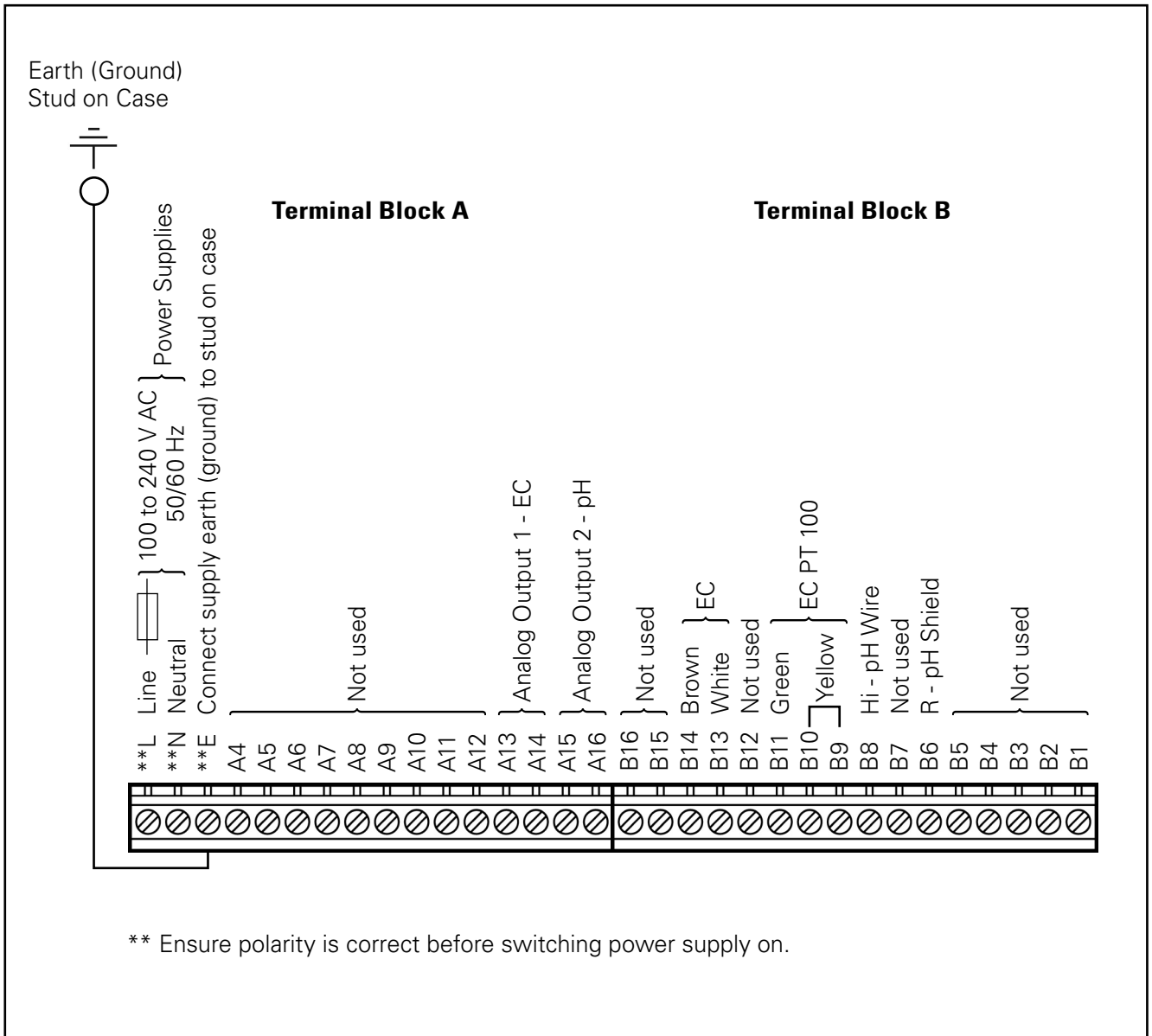

# INSTALLATION

## Panel-mount Analyzer Connections

### Access to Terminals

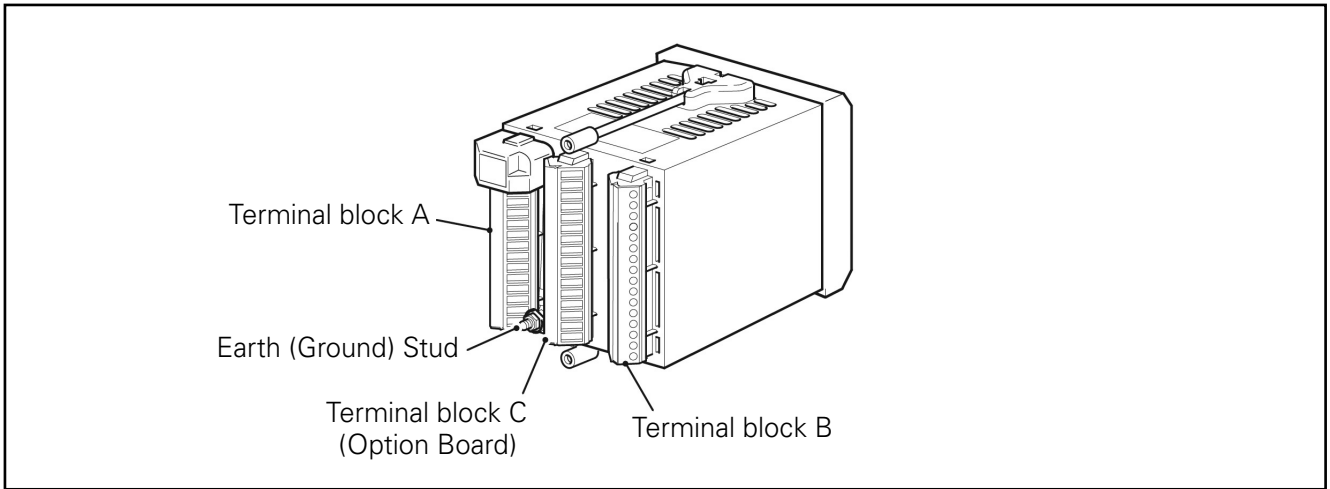

### Connections

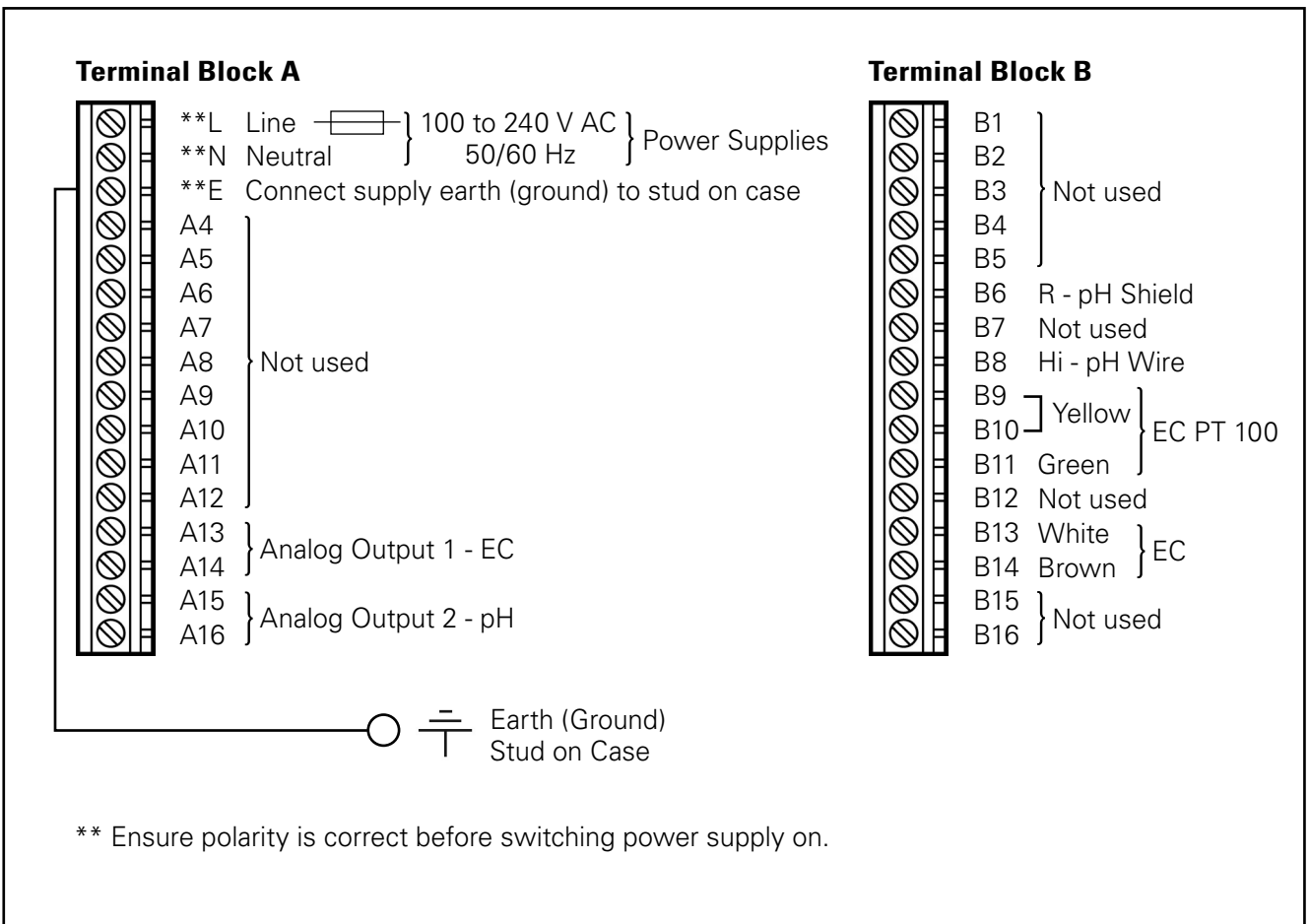

# MAINTENANCE, SIMPLE FAULT FINDING

## Maintenance instructions

The pH sensor requires periodic maintenance of cleaning and calibration. The duration between one periodic cleaning and calibration to the next depends on process conditions and the user's accuracy.

The recommended period between calibrations of the pH sensor should not exceed 2 weeks.

The EC sensor requires periodic maintenance too, but not as frequently as the pH sensor since it's not so sensitive.

The recommended period between calibrations of the EC sensor should not exceed 1 month.

## No Response to Conductivity Changes

The majority of problems are associated with the conductivity cell which must be cleaned as an initial check. It is also important that all program parameters have been set correctly and have not been altered inadvertently.

## Calibration Fail Message or No Response to pH/Redox Changes

The majority of problems are associated with the electrodes and cabling. Replace the electrodes as an initial check - refer to the appropriate instruction manual. It is also important that all program parameters have been entered correctly and have not been altered inadvertently.

## Chemical treatment of pH sensor

Immerse the probe in Sodium dioxide 2-3% for 2 minutes. Wash with fresh water. Perform Autoset, and then regular calibration.

# SPARE PARTS

## Spare Parts Ordering Information

Image	Description	Cat. Number
	EC/PH TRANSDUCER WALL MOUNT ABB 100-240VAC 50/60Hz	74360-007700
	EC/PH TRANSDUCER PANEL MOUNT ABB 100-240VAC 50/60Hz	74360-007800
	EC/PH TRANSDUCER WALL MOUNT ABB 12-30VDC	74360-007900
	PH SENSOR JUMO 12MM PLASTIC BARED WIRES	45000-006701
	EC SENSOR JUMO TEMPERAT COMP.PT100 12MM	45000-006705
	PVC UNION ADAPTOR SET FOR JUMO SENSOR	33120-008500
	MILWAUKEE PH4.01 BUFFER SOLUT 20ML SACHET	45000-006440
	MILWAUKEE PH7.01 BUFFER SOLUT 20ML SACHET	45000-006460
	MILWAUKEE EC1.413 BUFFER SOLUT 20ML SACHET	45000-006480

# SPECIFICATION

## Mechanical Data

### Wall-/Pipe-mount versions

IP65 (not evaluated under UL certification)  
Dimensions 192 mm high x 230 mm wide  
x 94 mm deep  
(7.56 in. high x 9.06 in. wide x 3.7 in. deep)  
Weight 1 kg (2.2 lb)

### Panel-mount versions

IP65 (front only)  
Dimensions 96mm x 96mm x 162mm deep  
(3.78 in. x 3.78 in. x 6.38 in. deep)  
Weight 0.6kg (1.32 lb)

### Cable Entry Types

Standard 5 or 7 x M20 cable glands

## Power Supply

### Voltage requirements

100 to 240 V AC 50/60 Hz  
(90 V Min. to 264 V Max. AC)  
12 to 30 V DC

### Power consumption

10 W

### Insulation

Mains to earth (line to ground) 2 kV RMS

## Environmental Data

### Operating temperature limits

-20 to 55 °C (-4 to 131 °F)

### Storage temperature limits

-25 to 75 °C (-13 to 167 °F)

### Operating humidity limits

Up to 95 %RH non condensing

## EMC

### Emissions and immunity

Meets requirements of:  
EN61326 (for an industrial environment)  
EN50081-2  
EN50082-2

## Approvals, Certification and Safety

### Safety approval

UL

### CE Mark

Covers EMC & LV Directives  
(including latest version EN 61010)

### General safety

EN61010-1  
Overvoltage Class II on inputs and outputs  
Pollution category 2

## Languages

### Languages configurable:

English  
French  
German  
Italian  
Spanish

## Conductivity and pH

Description	Conductivity	pH
Range	0 - 10 mS	0 - 14 pH
Resolution	0.001 mS	0.01 pH
Units	mS/cm	pH
Accuracy	Better than 1% of reading	0.01 pH
Temp. Comp.	-10 - 200 °C	
Temp. Sensor	PT - 100	
Analog Out	4 - 20 mA 0 - 10 mS/cm	4 - 20 mA 0 - 14 pH

## Sensor Specification

Description	Conductivity	pH
Operating temp. limit	0 - 60 °C	0 - 60 °C
Pressure range limit	0 - 6 bar	0 - 6 bar
Cell constant	K = 1	
Temp. Comp.	PT - 100	

# WARRANTY

Prior to installation, the equipment referred to in this manual must be stored in a clean, dry environment, in accordance with the Company's published specification.

Periodic checks must be made on the equipment's condition.

In the event of a failure under warranty, the following documentation must be provided as substantiation:

- A listing evidencing process operation and alarm logs at time of failure.
- Copies of all storage, installation, operating and maintenance records relating to the alleged faulty unit.

Netafim warrants all the components of the product to be free of defects in material and workmanship for 1 (one) year from the date of installation, provided the installation has been reported to Netafim within 30 days of installation.

If the installation was not reported or was reported later than 30 days from the date of installation, Netafim will warrant the product for a period of 18 months from the date of production, according to its serial number.

If a defect is discovered during the applicable warranty period, Netafim will repair or replace, at its discretion, the product or the defective part.

The above does not apply to EC and pH sensors, since they are wearable. Netafim will warrant these items to be free of defects in material and workmanship for 3 months from the date of installation, provided the installation has been reported to Netafim within 30 days, or 6 months from date of production if installation was not reported or was reported later than 30 days from the date of installation.



## NOTE

When not installed, the pH sensor must be immersed in KCL solution at all time, protected from freezing and not be exposed to pressure greater than 7 bars (100 PSI). Damage due to these causes is not covered by warranty.

This warranty does not extend to repairs, adjustments or replacements of a product or part that results from misuse, negligence, alteration, force majeure, lightning, power surge, improper installation or improper maintenance.

If a defect arises in your Netafim product during the warranty period, contact your Netafim supplier.

## Limited warranty

This warranty is subject to the terms and conditions contained in Netafim's official warranty statement, as such is in force from time to time.

For the full text of Netafim's official warranty statement, go to:

<http://www.netafim.com/irrigation-products-technical-materials>

**GROW MORE WITH LESS**

[WWW.NETAFIM.COM](http://WWW.NETAFIM.COM)