

LIMITATIONS:

ALLOWING FOR A WIDE VARIETY OF APPLICATIONS AND CONDITIONS, NETAFIM IRRIGATION INC. IS NOT RESPONSIBLE FOR CORRECTNESS OR APPLICABILITY TO PURPOSE OR COMPATIBILITY TO ANY SITE OR JOB CONDITION. WARRANTY FOR SUITABILITY IS NOT GIVEN OR IMPLIED. MODIFICATIONS FOR SPECIFIC PURPOSES MAY BE NECESSARY AND ARE THE SPECIFIER'S RESPONSIBILITY. THE USE OF THESE DETAILS SHALL NOT BE RESTRICTED AND PUBLICATION THEREOF IS NOT LIMITED TO ANY PURPOSE. REPRODUCTION, PUBLICATION AND REUSE BY ANY METHOD IN WHOLE OR PART IS FULLY AUTHORIZED. OWNERSHIP IS RETAINED BY NETAFIM IRRIGATION INC. VISUAL CONTACT WITH THESE DETAILS SHALL CONSTITUTE PRIMA FACIE EVIDENCE OF THE ACCEPTANCE OF THESE RESTRICTIONS.

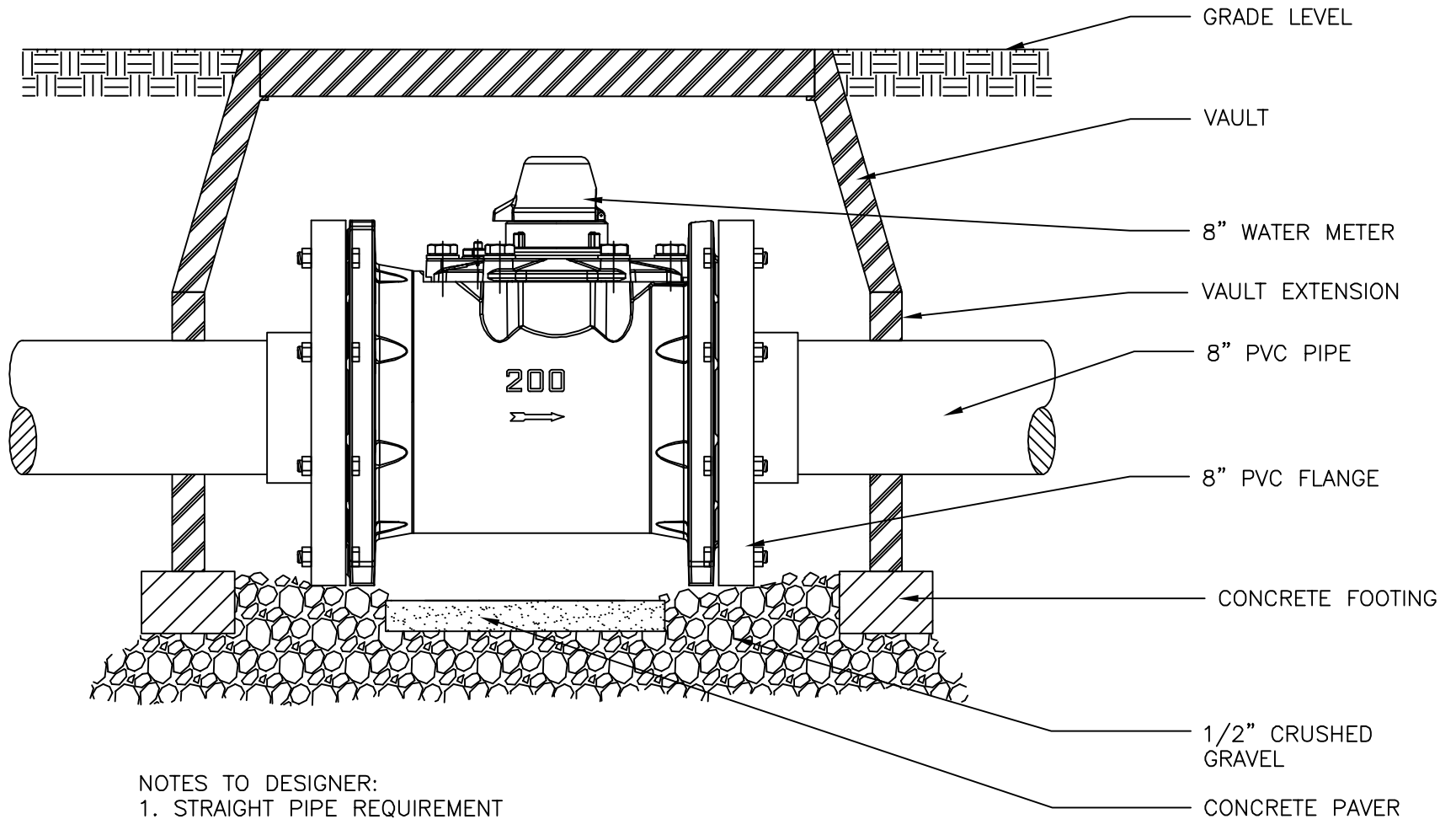

- NOTES TO DESIGNER:
1. STRAIGHT PIPE REQUIREMENT
 2. INSTALL AIR VENT UPSTREAM OF WATER METER

00

WATER METER 8" FLG

NOT TO SCALE



DETAIL - WMM08V