

# ALPHADISC™ BLE

Smartphone Operated Controller  
for Filtration Systems

Installation, Operation and Maintenance  
Instructions

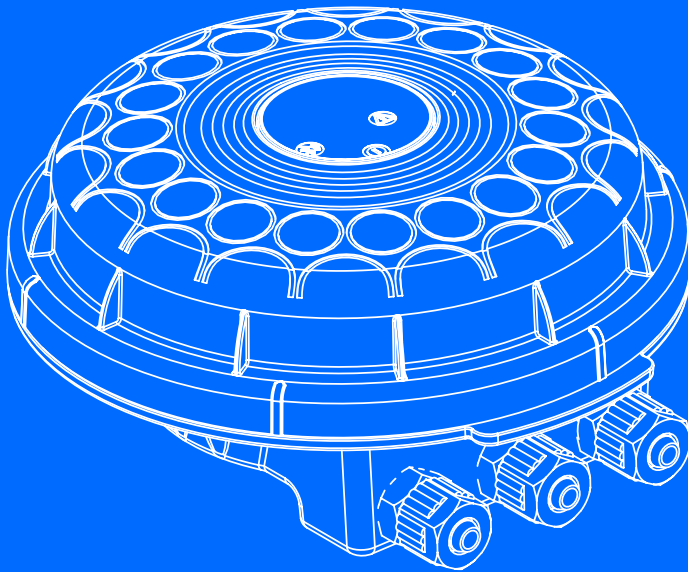

Patent Pending



2021  
v1.0



## Netafim Ltd.

AlphaDisc™ BLE - Patent Pending Smartphone Operated Controller for Filtration Systems

Netafim's AlphaDisc™ BLE is a smartphone operated controller for filtration systems that is available in two main configurations:

- An integrated device for controlling one or two new filters
- A standalone device for controlling one or two existing filters

The AlphaDisc™ BLE system consists of two major components: The AlphaDisc™ BLE Controller and the AlphaDisc™ BLE Mobile Application.

In this document, you will find the AlphaDisc™ BLE Controller features including updates starting from firmware version #1.1.14.

## Contents

Safety First.....	4
General Safety Instructions .....	4
Installation .....	4
Commissioning.....	5
Operation and Control .....	5
Before any maintenance or non-standard operation .....	5
Introduction .....	6
AlphaDisc™ BLE Controller Quick Guide.....	6
Screens Details:	
Download and Export Reports.....	13
Specifications Table.....	14
AlphaDisc™ BLE Terminal Blocks Connections .....	15
Annex A. Chaining AlphaDisc™ BLE Controllers .....	16
Connection instructions.....	17
Annex A. Chaining AlphaDisc™ BLE Controllers .....	18
Netafim Limited Warranty.....	20

Products appearing in this catalog may be covered by one or more of the following US Patent Nos. 7644735, 7410108 and other U.S. patents pending or corresponding issued or pending foreign patents. All rights are reserved. You are specifically prohibited and not allowed to reproduce, copy, duplicate, manufacture, supply, sell, hire, distribute or adapt all or any part of this publication including any packaging. Netafim™, are trademarks of Netafim™ Ltd., registered in the U.S. and other countries. We endeavor to provide accurate, quality and detailed information. However we cannot accept liability for your reliance on the provided information and you are advised to independently seek professional advice from Netafim™ and/or its authorized representatives. There is no undertaking by us that the provided information or any part thereof is accurate, complete or up to date. Mention of third-party products is for informational purposes only and constitutes neither an endorsement nor a recommendation. Netafim™ assumes no responsibility with regard to the performance or use of these products. In no event shall Netafim™ be liable for any indirect, incidental, special or consequential damages.

## GENERAL SAFETY INSTRUCTIONS

- ✓ The manufacturer's filtration products always operate as components in a larger system. System designers, installers and operators must comply with all relevant safety standards.
- ✓ Prior to installation, operation, maintenance and/or any other type of action carried out on the controller, carefully read these installation and operation instructions.
- ✓ During installation, operation and/or maintenance of the controller all conventional safety instructions must be observed in order to avoid danger to the workers, the public and/or to property in the vicinity.
- ✓ The system is for use for non-hazardous liquids only!
- ✓ Please note: The filter controlled by the controller enters the flushing mode automatically without any prior warning.
- ✓ No change or modification to the equipment is permitted without written notification given by the manufacturer or by its representative(s) on the manufacturer's behalf.
- ✓ Always observe standard safety instructions and good engineering practices whilst working in the filter's vicinity.
- ✓ Use the controller only for its intended use as designed by the manufacturer only. Any misuse of the controller may lead to damage and may affect your warranty coverage. Consult with the manufacturer prior to any non-standard use of this equipment.
- ✓ Do not carry out system cleaning and/or maintenance in an explosive atmosphere.

## INSTALLATION

### General

- ✓ Install the controller according to the detailed installation instructions provided in this manual or in the Quick Guide provided with the filter or controller.
- ✓ Make sure to leave enough side and top clearance to enable easy access for safe maintenance operations.
- ✓ Make sure to have suitable lighting at the filter's location to enable good visibility and safe maintenance.
- ✓ Arrange suitable platforms and safety barriers to enable easy and safe access to the controller without needing to climb on pipes and other equipment. Verify that any platform, barrier, ladder or other such equipment is built, installed and used in accordance with the relevant local authorized standards.
- ✓ Use only appropriate standard tools and equipment operated by qualified operators when installing, operating and maintaining the controller.
- ✓ When installation is required in hazardous environment sites, underground or high above ground, make sure that the site design and the auxiliary equipment are appropriate and that installation procedures are carried out in accordance with the relevant standards and regulations.
- ✓ Ensure walking areas around the installation are slip resistant when wet.

### Shipment and transporting

- ✓ Shipping and transporting the controller must be done in a safe and stable manner and in accordance with the relevant standards and regulations.

### Electricity

- ✓ Electric wiring must be performed by an authorized electrician only, using standardized and approved components.
- ✓ The filter should be installed in a manner in which the controller's electrical components are protected from direct contact with water.
- ✓ When using external power a 1A external fuse and minimum 22AWG wires are required.

## COMMISSIONING

- ✔ Carefully read this manual prior to operating the controller.
- ✔ In order to achieve maximum performance and smooth operation of the controller, performing the start-up and first operation procedures exactly as described in this manual is crucial.

## OPERATION AND CONTROL

- ✔ Do not operate the controller before carefully reading and becoming familiar with its operation instructions.
- ✔ Observe the safety stickers on the controller and do not perform any operation other than those given in this manual.
- ✔ Do not operate or use the controller for purposes other than its original design.
- ✔ The system is for use for non-hazardous liquids only!
- ✔ Do not carry out system cleaning and/or maintenance in an explosive atmosphere.

## BEFORE ANY MAINTENANCE OR NON-STANDARD OPERATION

- ✔ Servicing the controller should be done only by technicians authorized by the manufacturer.
- ✔ Do not carry out system cleaning and/or maintenance in an explosive atmosphere.
- ✔ Disconnect the controller and the filter from the power supply and lock the main power switch.

## PREVENTING DAMAGE DUE TO FROST

- ✔ Non-operating periods:  
To avoid damage or breakage when temperatures drop, command tubes must be disconnected and drained prior to non-operating periods.
- ✔ Operating season:  
Your AlphaDisc™ BLE controller is equipped with a built-in feature that detects low temperatures and increases the number of flushes to avoid freezing of water. You can activate and adjust the settings of this feature in your Settings menu.

# Introduction

Thank you for purchasing the AlphaDisc™ BLE controller - a smartphone operated controller for filtration systems of up to two filters. The system consists of two major components, the AlphaDisc™ BLE Controller and the AlphaDisc™ BLE Mobile Application.

The AlphaDisc™ BLE Controller can be supplied in two different configurations: as an integral component already connected to the filter(s) and configured for that specific filter model or as a standalone unit to be connected and configured for an existing installed filter(s). This document covers both product configurations.

For additional information about the AlphaDisc™ filter, please scan the QR code or visit our [website](#).



## AlphaDisc™ BLE Controller Quick Guide

(for detailed information see Understanding the application's screens data items on page 10)

Take few moments to familiarize yourself with the AlphaDisc™ BLE Controller components:

### SHIPMENT AND TRANSPORTING

- Shipping and transporting the controller must be done in a safe and stable manner and in accordance with the relevant standards and regulations.

### ELECTRICITY

- Electric wiring must be performed by an authorized electrician only, using standardized and approved components.
- The filter should be installed in a manner in which the controller's electrical components are protected from direct contact with water.
- When using external power a 1A external fuse and minimum 22AWG wires are required.



Single solenoid controller



Dual solenoid controller

- AlphaDisc™ BLE panel for manual flushing button and indication LEDs
- 3-Way 12VDC solenoid #1 – latch

- 3-Way 12VDC solenoid #2 – latch
- Solenoids' manual operation handles
- AlphaDisc™ BLE cover

## INITIAL OPERATION OF THE ALPHADISC™ BLE CONTROLLER:

Open the cover of the AlphaDisc™ BLE Controller by turning it counterclockwise [1] and insert four alkaline 1.5V AA batteries [2]. The Power LED turns on and the AlphaDisc™ BLE Controller starts operating according to its pre-defined

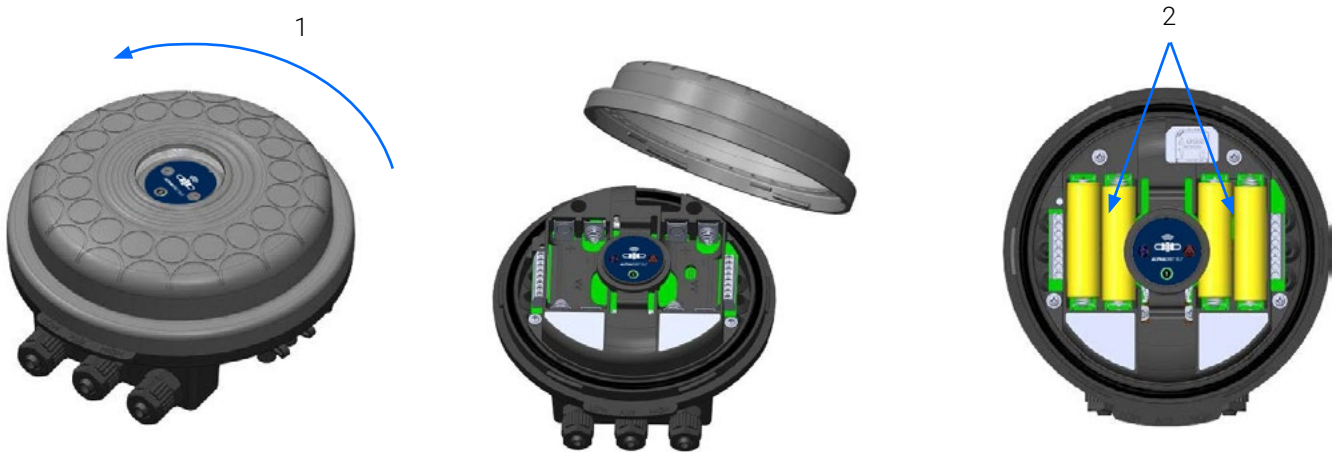

## DOWNLOADING THE MOBILE APPLICATION:

 The free AlphaDisc™ BLE application by Netafim is available for download on Google Play (Android version 5 and up) or the App Store (iOS version 9 and up).

## PAIRING THE CONTROLLER WITH YOUR MOBILE PHONE:

1. Activate your phone's Bluetooth® discovery mode and start the AlphaDisc™ BLE application.
2. Select the applicable SYSTEM UNITS.
3. REGISTER your filter to create an account.

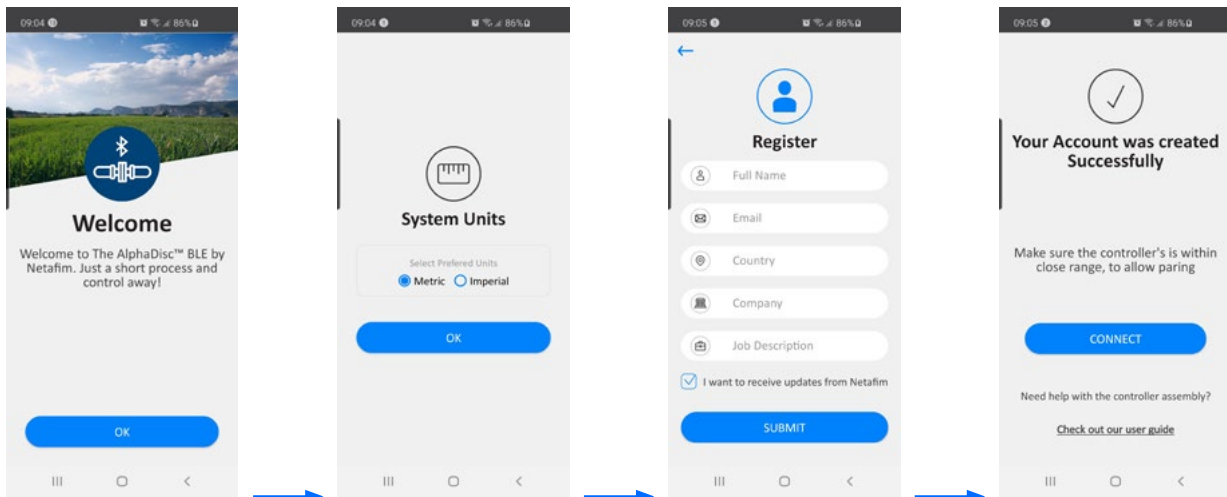

Click CONNECT. The application scans for controllers within Bluetooth® range.

5. Select your controller from the list of controllers in range. Verify that the blue/green LED on your controller is blinking before clicking YES to initiate the pairing process.
6. Confirm the pairing process.

Complete the SITE ID form.

- a. Controller supplied with filter: Name your site and then select "Predefined". The application reads the filter model and controller's serial number automatically.
- b. Controller purchased separately: Name your site, select the filter model and enter your controller's serial number.

You may add a site photo by clicking on 

- 8. Enter the SITE INFO details (optional).
- 9. Once done, click SUBMIT to add your new filter to the SITE LIST.

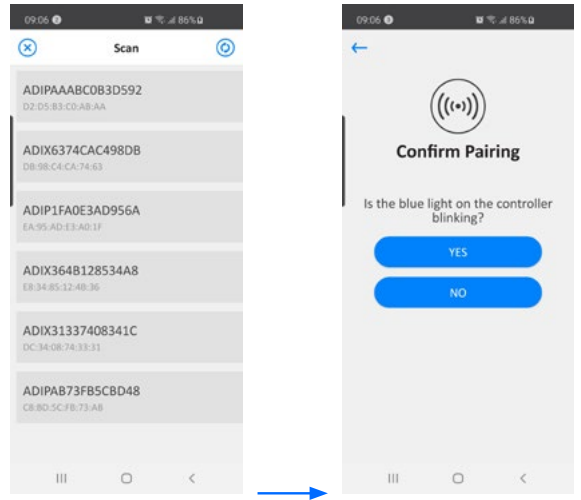

- 10. In order to view data from your controller, select the active controller from the SITE LIST, marked by the active Bluetooth® icon.

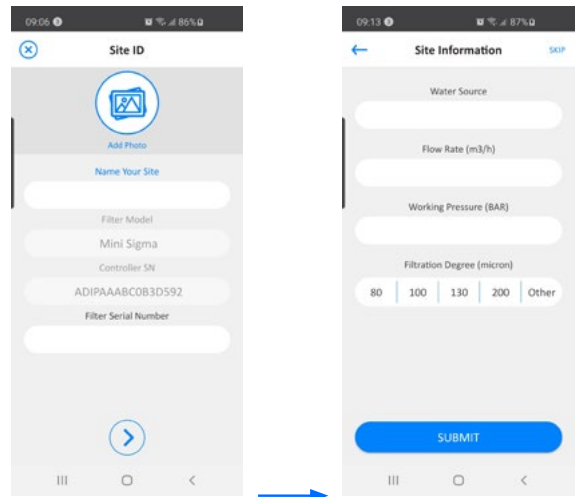

- 11. The ONLINE STATUS screen appears and relevant data regarding your filter's performance can be viewed.

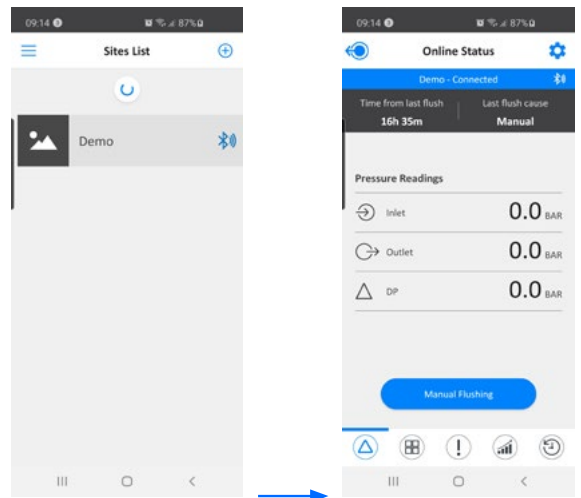



## GETTING TO KNOW THE ALPHADISC™ BLE APPLICATION:

Take a few moments to familiarize yourself with the AlphaDisc™ BLE mobile application interface: Once running and controlling the filter, the application has 5 main screens. Scroll through these screens by sliding to

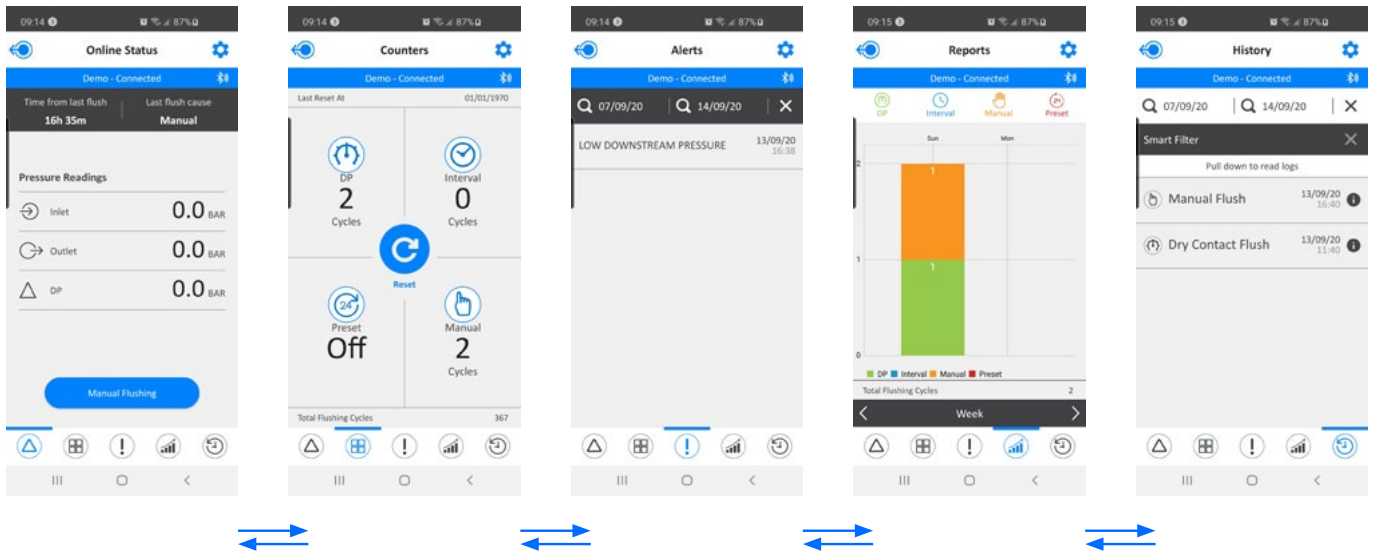

You may also reach the desired screen by clicking on the designated icons that appear at the bottom of the screen.

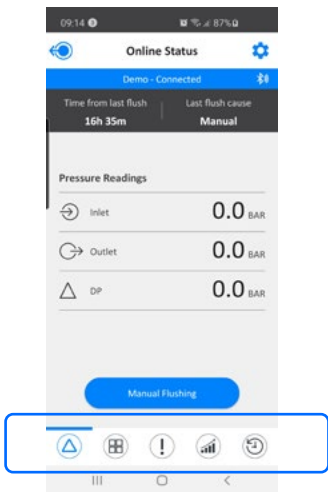

## SCREENS DETAILS

THE ONLINE STATUS SCREEN:	
THE UPPER RED LINE	DISPLAYS THE NAME OF THE CURRENTLY CONNECTED CONTROLLER AND THE COMMUNICATION STATUS.
TIME FROM LAST FLUSH	THE TIME SINCE THE END OF THE LAST FLUSH CYCLE.
LAST FLUSH CAUSE	THE TRIGGER THAT INITIATED THE LAST FLUSH.
PRESSURES - INLET	THE CURRENT READING OF THE FILTER'S INLET PRESSURE.
PRESSURE - OUTLET	THE CURRENT READING OF THE FILTER'S OUTLET PRESSURE.
PRESSURE - DP	THE PRESSURE DIFFERENTIAL ACROSS THE FILTER; CALCULATED BY SUBTRACTING THE OUTLET PRESSURE FROM THE INLET PRESSURE.
MANUAL FLUSHING	PRESS THIS ICON TO START A MANUAL FLUSH CYCLE.

THE COUNTERS SCREEN:	
THE UPPER RED LINE	DISPLAYS THE NAME OF THE CURRENTLY CONNECTED CONTROLLER AND THE COMMUNICATION STATUS.
LAST RESET AT:	THE DATE OF THE LAST RESETTING OF THE COUNTERS.
DP CYCLES	THE NUMBER OF FLUSH CYCLES STARTED DUE TO A DP SIGNAL.
INTERVAL CYCLES	THE NUMBER OF FLUSH CYCLES STARTED DUE TO THE TIME INTERVALS PROGRAM. ALSO COUNT THE ANTIFREEZE PROTECTION INTERVALS FLUSHES
PRESET	THE NUMBER OF FLUSH CYCLES STARTED DUE TO THE PRESET DAILY START TIME AND THE CURRENT STATUS OF THIS PROGRAM.
MANUAL CYCLES	THE NUMBER OF FLUSH CYCLES STARTED DUE TO A MANUAL START COMMAND ISSUED BY THE USER.
TOTAL FLUSHING CYCLES	THE TOTAL NUMBER OF FLUSH CYCLES STARTED FOR ANY REASON.
RESET BUTTON	PRESS THIS BUTTON TO RESET THE COUNTERS TO ZERO.

ALERTS SCREEN:	
THE UPPER RED LINE	DISPLAYS THE NAME OF THE CURRENTLY CONNECTED CONTROLLER AND THE COMMUNICATION STATUS.
THE SECOND LINE	ENABLES SORTING ALERTS BETWEEN TWO DATES AND RESETTING AN ALERT.
THE ALERTS LIST (SEE BELOW)	DISPLAY THE ALERT MESSAGES ACCORDING TO THEIR OCCURRENCE TIME AND DATE.

ALARMS AND FAULTS LIST:		
ALERT	POSSIBLE CAUSE	RECOMMENDED ACTION
LOW BATTERY	LOW BATTERY VOLTAGE	REPLACE ALL 4 CONTROLLER BATTERIES
LOW BATTERY PAUSE	CONTROLLER PAUSED DUE TO LOW BATTERY VOLTAGE	REPLACE ALL 4 CONTROLLER BATTERIES
HIGH DP ALARM	DP VALUE IS >= HDA THRESHOLD (UNITS: BAR/100)	ALERT ONLY
HIGH DP FAULT	DP VALUE IS >= HDF THRESHOLD (UNITS: BAR/100)	ALERT ONLY
CONTINUOUS MODE ALERT	CONTROLLER EXCEEDED NUMBER OF CONSECUTIVE FLUSHES FOR ALERTS	CHECK CONFIGURATION/CHECK DP: IF HIGH, PERFORM MANUAL FLUSH WITH DOWNSTREAM VALVE CLOSED, OPEN THE FILTER FOR INSPECTION
DFU FAILED	FIRMWARE UPDATE FAIL	VALIDATE CELLULAR RECEPTION AND TRY AGAIN
OUT OF RANGE APP CONNECTION	CONTROLLER OUT OF RANGE DURING CONNECTION SESSION	GET CLOSER TO THE CONTROLLER WITH THE SMARTPHONE (WITHIN BLUETOOTH® RANGE)
SENSOR PRESSURE READ FAILED	THE NUMBER OF THE SENSOR THAT FAILED TO READ. INLET(0), OUTLET(1), PISTON(2)	IF CONTINUES - CONTACT SUPPORT
CAPACITOR CHARGER START FAILED	UNABLE TO CHARGE CAPACITOR	CONTACT SUPPORT
LOAD CAPACITOR TIMEOUT	CAPACITOR CHARGE TIMEOUT	CHECK BATTERY VOLTAGE LEVEL, CONTACT SUPPORT
LOW DOWNSTREAM PRESSURE	THE OUTLET PRESSURE IS LESS THAN 1.5 BAR	CHECK THE FILTER AND THE WATER SYSTEM
HIGH UPSTREAM PRESSURE	THE INLET PRESSURE IS GREATER THAN MAXIMUM ALLOWED PRESSURE FOR THE FILTER	ADJUST THE WATER SYSTEM INLET PRESSURE
ANTI FREEZE ACTIVE	FREEZING PROTECTION START, AS A RESULT OF LOW TEMPERATURE THRESHOLD	
ANTI FREEZE EXIT	STOP FREEZING PROTECTION PROCEDURE	

REPORTS SCREEN:	
THE UPPER RED LINE	DISPLAYS THE NAME OF THE CURRENTLY CONNECTED CONTROLLER AND THE COMMUNICATION STATUS.
THE SECOND LINE	DISPLAYS ICONS OF THE DIFFERENT FLUSH TYPES. SELECT THE DESIRED ICONS TO BE DISPLAYED ON THE CHART.
THE CHART WINDOW	DISPLAYS THE NUMBER OF FLUSH CYCLES ACCORDING TO THE SELECTED ICONS.
TOTAL FLUSHING CYCLES	THE TOTAL NUMBER OF FLUSH CYCLES CURRENTLY DISPLAYED IN THE CHART WINDOW.
THE LOWER BLACK LINE	ENABLES THE USER TO SELECT THE CHART'S TIME SPAN (DAY, WEEK, MONTH).

HISTORY SCREEN:	
THE UPPER RED LINE	DISPLAYS THE NAME OF THE CURRENTLY CONNECTED CONTROLLER AND THE COMMUNICATION STATUS.
THE SECOND LINE	ENABLES SORTING EVENTS BETWEEN TWO DATES AND DELETING AN EVENT.
THE BLACK LINE	ENABLES FILTERING EVENTS ACCORDING TO THE FOUR FLUSH TYPES (DP, INTERVAL, MANUAL, PRESET, ANTI FREEZE).
THE EVENTS LIST	DISPLAY THE EVENTS MESSAGES ACCORDING TO THEIR OCCURRING TIME AND DATE.

## THE MENU SCREENS:

ENTER THE MENU SCREENS BY TAPPING ON THE MENU ICON IN THE UPPER LEFT CORNER OF THE SITE LIST SCREEN:	
SYSTEM UNITS	SELECT THE SYSTEM ENGINEERING UNITS: METRIC OR US.
LANGUAGE	SELECT THE APPLICATION USER INTERFACE LANGUAGE: ENGLISH, FRENCH, GERMAN, HEBREW, ITALIAN, PORTUGUESE, RUSSIAN OR TURKISH.
ACCOUNT	DISPLAYS THE REGISTRATION DETAILS OF THE SYSTEM: USER NAME, USER E-MAIL, USER COUNTRY, USER COMPANY AND USER JOB DESCRIPTION.
USER MANUAL	THIS SCREEN SHOWS THE USER MANUAL.
SUPPORT	CONTACT US SCREEN.
APP VERSION	DISPLAYS THE CURRENT VERSION OF THE ALPHADISC™ BLE APPLICATION.
MESSAGES	MESSAGES FROM THE NETAFIM SYSTEM

## THE SETTINGS SCREENS:

ENTER THE SETUP SCREENS BY TAPPING ON THE SETTINGS ICON IN THE UPPER RIGHT CORNER OF ANY OF THE 5 MAIN SCREENS:	
THE UPPER RED LINE	DISPLAYS THE NAME OF THE CURRENTLY CONNECTED CONTROLLER AND THE COMMUNICATION STATUS.
CONTROLLER STATE	DISPLAYS THE CURRENT CONTROLLER STATE AND ALLOWS THE USER TO SWITCH THE CONTROLLER ON AND OFF
DP SET POINT	DISPLAYS THE DP LEVEL FOR STARTING A FLUSH CYCLE AND ALLOWS THE USER TO ENABLE OR DISABLE THE DP OPERATION.
THE RECOMMENDED SETTING IS DISPLAYED AT THE BOTTOM OF THE SCREEN.	
INTERVAL	ALLOWS THE USER TO SET THE TIME INTERVALS FOR FLUSHING AND ENABLE OR DISABLE THE FLUSHING ACCORDING TO TIME INTERVALS.
THE RECOMMENDED SETTING IS DISPLAYED AT THE BOTTOM OF THE SCREEN.	
DAILY PRESET FLUSH	ALLOWS THE USER TO SET SPECIFIC FLUSHING START TIMES. START TIME CAN BE SET AS DAILY START TIMES OR SINGLE-TIME START TIMES. THE USER CAN SET UP TO 8 START TIMES.
FLUSH TIME	ALLOWS THE USER TO SET THE DURATION OF THE FLUSH OPERATION. THE RECOMMENDED SETTING IS DISPLAYED AT THE BOTTOM OF THE SCREEN.
DWELL TIME	IN CASE THE SYSTEM OPERATES TWO FILTERS, THIS PARAMETER ALLOWS THE OPERATOR TO SET THE TIME DELAY BETWEEN THE FLUSH CYCLES OF THE FIRST AND SECOND FILTERS.
BATTERY	DISPLAYS THE CURRENT CHARGE LEVEL OF THE CONTROLLER'S BATTERIES.
ID	ENABLES THE USER TO SET THE SITE'S PICTURE, NAME AND ID PARAMETERS SUCH AS: FILTER MODEL, CONTROLLER'S SERIAL NUMBER AND FILTER SERIAL NUMBER. THE SECOND SCREEN ALLOWS THE USER TO SELECT THE TYPE OF THE WATER SOURCE, FLOW-RATE, THE WORKING PRESSURE AND THE FILTRATION DEGREE OF THE FILTER. PRESS SUBMIT TO SUBMIT THE DATA.
TECHNICIAN SETTINGS	SEE THE FOLLOWING TABLE.
ABOUT	DISPLAYS THE CURRENT DEVICE ID, APP VERSION, FIRMWARE VERSION, HARDWARE VERSION, BOOTLOADER VERSION, CONTROLLER INSTALLATION DATE. IF UPDATED FIRMWARE IS AVAILABLE THIS SCREEN PROMPTS THE USER TO UPDATE THE SYSTEM BY PRESSING THE UPDATE NOW BUTTON.

## TECHNICIAN SETTINGS SCREENS:

This section of the application contains the system's basic and fundamental settings. Do not change any of these settings if you are not totally familiar with the specific filtration system, filters and controller. Incorrect settings may cause the system to become nonoperational.

Access to the Technician Settings screens requires a password. Please contact your dealer to obtain a password.

THE UPPER BLACK LINE	ALLOWS THE TECHNICIAN TO SEARCH FOR A SPECIFIC DATA ITEM.
FILTER TYPE	SELECT THE SPECIFIC FILTER(S) MODEL CONTROLLED BY THE CURRENT CONTROLLER.
OPERATION MODE	SELECT THE OPERATION MODE OF THIS CONTROLLER; CONTROLLER = PRIMARY PRIMARY = THE FIRST CONTROLLER IN A CHAIN OF CONTROLLERS OR A STAND-ALONE CONTROLLER. SECONDARY = A MEMBER OF A CHAIN OF CONTROLLERS WHICH IS CONTROLLED BY A PRIMARY CONTROLLER. DP SENSOR = SET THIS CONTROLLER AS THE SOURCE OF DP SIGNAL FOR THE CONTROLLER CHAIN.
PAUSE INTERVAL FLUSH IF DP IS LESS THAN	SET A DP VALUE TO SERVE AS A MINIMAL DP LEVEL FOR STARTING A FLUSH CYCLE BY THE TIME INTERVALS PARAMETER. IF THE DP READING IS LOWER THAN THIS VALUE THE FLUSH CYCLE BY TIME INTERVAL WILL NOT START.
INTERVAL FLUSH PAUSE	ENABLE OR DISABLE THE OPERATION OF THE TIME OPERATION MODE THRESHOLD PARAMETER.
DP DELAY	SET THE TIME THAT THE DP SIGNAL SHOULD BE ON BEFORE STARTING FLUSHING ACCORDING TO A DP SIGNAL. THIS PARAMETER IS USED TO ELIMINATE UNNECESSARY FLUSHING DUE TO A MOMENTARY HIGH DIFFERENTIAL PRESSURE.
HIGH DP ALARM SET POINT	SET THE DP LEVEL FOR ISSUING A HIGH DP ALARM MESSAGE (SYSTEM LOG).
REPEATED FLUSHES TO START FAULT MODE	SET THE NUMBER OF CONTINUOUS FLUSH CYCLES SO THE ALPHADISC™ BLE CONTROLLER ENTER TO FAULT MODE .
CYCLE TIME FOR CONTINUOUS	SET THE CYCLE TIME FOR COUNTING A FLUSH CYCLE AS CONTINUOUS FLUSHING. IF THE TIME BETWEEN TWO FLUSH CYCLES IS SHORTER THAN "MINIMUM CYCLE TIME FOR CONTINUOUS STATUS" – THEN IT'S COUNTED AS CONTINUOUS FLUSHING.
ACTION IN CONTINUOUS	SELECT THE ACTION TO TAKE WHEN CONTINUOUS FAULT MODE IS DETECTED: IGNORE: IGNORE THE ALERT AND CONTINUE FLUSHING ACCORDING TO DP SET POINT. TIME ONLY: STOP FLUSHING ACCORDING TO DP MEASUREMENT AND FLUSH ACCORDING TO TIME INTERVAL ONLY.
IGNORE DP AFTER FLUSH	SET THE TIME DURATION AFTER THE END OF A FLUSH CYCLE DURING WHICH THE DP READING IS IGNORED.
END OF CYCLE	SET THE TIME FOR THE END OF CYCLE SIGNAL TO BE ON AFTER THE FLUSH CYCLE ENDS.
RELAY OUTPUT	SET THE OPERATION OF THE OUTPUT RELAY TO EOC (END OF CYCLE ON), ALARM (SET THIS OUTPUT AS AN ALARM OUTPUT) OR DISABLE (THE RELAY IS NOT ACTIVE).
VALVE 2 MODE	IT IS POSSIBLE TO CONNECT A SECOND SOLENOID TO THE SYSTEM THAT CAN OPERATE AS A SECOND FILTER OR A DOWNSTREAM VALVE. SET THE TASK FOR THE SECOND SOLENOID: DISABLE, 2ND FILTER OR DOWNSTREAM. WHEN A DOWNSTREAM VALVE IS SELECTED A NEW ENTRY FIELD IS ADDED TO THE TECHNICIAN SCREENS LIST FOR SETTING THE DELAY TIME FOR THE DOWNSTREAM VALVE.
IO SCREEN	THIS SCREEN DISPLAYS THE STATUS OF THE SYSTEM'S I/OS ACCORDING TO THE CURRENTLY DESIGNATED FILTER MODEL: DIGITAL INPUT 1 TYPE, DIGITAL INPUT 3 TYPE, THE MAXIMAL READING OF THE INLET PRESSURE, THE MINIMAL READING OF THE OUTLET PRESSURE, THE PISTON PRESSURE AND THE CURRENT BATTERY VOLTAGE. THIS SCREEN ALSO ALLOWS THE TECHNICIAN TO TEST THE OPERATION OF THE SYSTEM OUTPUTS: SOLENOID 1, SOLENOID 2 AND THE OUTPUT RELAY. SELECT ON OR OFF.
FREEZING PROTECTION	FREEZING PROTECTION - THIS FUNCTION IS COME TO PREVENT FROM THE FILTER TO FREEZE IN LOW TEMPERATURE WHILE IT CONNECTED TO WATER SOURCE. DEFAULT: ENABLE
LOW TEMPERATURE THRESHOLD	FREEZING PROTECTION - TEMPERATURE SETPOINT TO START FILTER FLUSHING. DEFAULT: 4°C
PROTECTING FLUSHING INTERVAL	FREEZING PROTECTION - FLUSHING INTERVAL WHILE FREEZING PROTECTION IS ACTIVATED. DEFAULT: 60 MIN

**Important note:** make sure to press SAVE after changing any of the above technician settings.

## ADDITIONAL SETTINGS SCREENS:

EXPORT DATA	THIS SCREEN ALLOWS THE USER TO EXPORT THE CONTROLLER'S DATA (AS AN EXCEL FILE). THE SCREEN DISPLAYS A LIST OF SUPPORTED APPLICATIONS FOR EXPORTING THE DATA (DEPENDING ON THE APPLICATIONS ALREADY INSTALLED ON THE USER'S SMARTPHONE).
RESTORE TO FILTER TYPE SETTINGS	ALLOWS THE USER TO RESET THE CONTROLLER'S DATA AND RESTORE THE DEFAULT PARAMETERS FOR THE CURRENT FILTER TYPE WHICH IS CONTROLLED BY THIS CONTROLLER.
RESTORE TO FACTORY SETTINGS	ALLOWS THE USER TO DELETE ALL OF THE CONTROLLER'S DATA AND RESTORE THE FACTORY DEFAULT SETTINGS; THE DEFAULT FILTER MODEL WILL BE ACCORDING TO THE FILTER PROVIDED WITH THE CONTROLLER, OR ACCORDING TO THE CUSTOMER'S INITIAL SETTINGS.
DELETE	ALLOWS THE USER TO DELETE A SITE FROM THE SMARTPHONE.

## / Download and Export Reports

In addition to the on-screen reports, the AlphaDisc™ BLE is capable of logging, storing, downloading and exporting status and operation data through the user's smartphone.

1. Enter the «Export Data» section of the Settings Screen; In order to make sure that the system exports the latest data, refresh the screen (slide your finger along the screen from top to bottom).

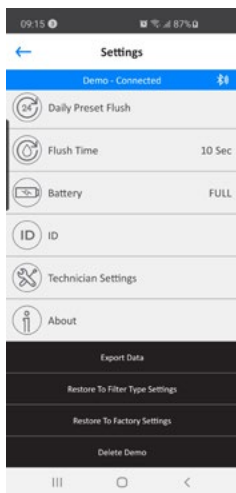

2. Depending on the general communication applications installed on your smartphone, the AlphaDisc™ BLE application displays the various options for sending the reports.
3. Select the preferred application, the recipient and send the reports.
4. AlphaDisc™ BLE sends 5 reports in CVS file format (Excel): system-id, parameters-setup, flush-events, alarm-events and params-setup-audit.

# Specifications Table

ITEM	DESCRIPTION		REMARKS
IDEAL WORKING PRESSURE	0-10 BAR	0-150 PSI	
BURST PRESSURE (PEAK)	20 BAR	300 PSI	
POWER	INTERNAL	4X1.5V AA BATTERIES	
	EXTERNAL	7-14 VDC	1A EXTERNAL FUSE, MIN 22 AWG WIRES
TEMPERATURE RANGE	(-)10°C TO (+)60°C	(+)14°F TO (+)140°F	
WEIGHT	0.5 KG	1.1 LB	
DP SENSOR	INTERNAL		
INTERNAL PISTON PRESSURE SENSOR	OPTIMIZED FLUSH TIME DURATION		
IP RATING	IP65		
USER INTERFACE	VIA SMARTPHONE APPLICATION		
FILTER MODELS	SIGMA PRO , MINI SIGMA , M104LPN , M104XLP , M106LP , M106XLP , M108LP , M110P , M102C , M103C , M103CL , M104C , M104CL , MG-110 , MG-112-M , MG-112-S , MG-114-M , MG-114-S , SK COMPACT 2"		
DIGITAL INPUTS	DP SWITCH, PAUSE		
CHAIN CONTROLLER OPTIONS	ONBOARD END OF CYCLE PULSE	NO, NC	
STANDARDS	FCC 47CFR PART 15: 2017, SUBPART B, CLASS B ICES-003: 2016 ISSUE 6, CLASS B AS/NZS CISPAR 32 :2015 CLASS B EN 61326-1: 2013, BASIC IMMUNITY REQUIREMENTS, CLASS B JEC 61010-1		

# AlphaDisc™ BLE Terminal Blocks Connections



Connector Block J1			Connector Block J2		
1	Power in +	Input external power 7-14VDC	8	Spare	N/A
2	Power In -	External power GND	7	GND	GND
3	Spare	N/A	6	Pause in	Dry contact to pause the controller
4	GND	GND	5	Solenoid 2 Red	Solenoid connection Red wire
5	External DP	Dry contact input for flush trigger	4	Solenoid 2 Black	Solenoid connection Black wire
6	GND	GND	3	Relay NC	Normally closed relay output
7	Solenoid 1 Black	Solenoid connection Black wire	2	Relay COM	Relay common connection
8	Solenoid 1 Red	Solenoid connection Red wire	1	Relay NO	Normally open relay output

## CONNECTING NO OR NC SOLENOIDS TO THE CONTROLLER

Connecting NO or NC solenoids to the AlphaDisc™ BLE Controller is possible depending on the filter type.

### NO VERSUS NC SOLENOIDS

- Please note that NO solenoids have black manual overriding handles while NC solenoids have red manual overriding handles.
- For both solenoid types do not change the wires connection at the controller's terminal strip; the black wire should be connected to the black solenoid connector and the red wire should be connected to the red solenoid connector.

# Annex A. Chaining AlphaDisc™ BLE Controllers

## GENERAL

It is possible to daisy-chain several AlphaDisc™ BLE Controllers in order to operate a battery of filters' flushing according to a single DP switch (either internal or external).

The DP switch that reads the pressure drop across the battery is the internal DP switch of the first controller in the chain (the Primary) or an external DP switch connected to the Primary Controller. The End of Cycle output of the Primary Controller is connected to the external DP input of the second controller in the chain (the first Secondary) and this controller's EC output is connected to the DP input of the rest. This type of connection can be spanned over as many controllers as needed. (See page 17 – Stage 1: Wires Connection).

When the actual DP switch sends a signal, the Primary Controller starts a flush cycle. Once this cycle is completed the Primary Controller sends a signal through its EC output to the second controller to start its flush cycle, and so on to the last controller in the chain, as illustrated in the following:

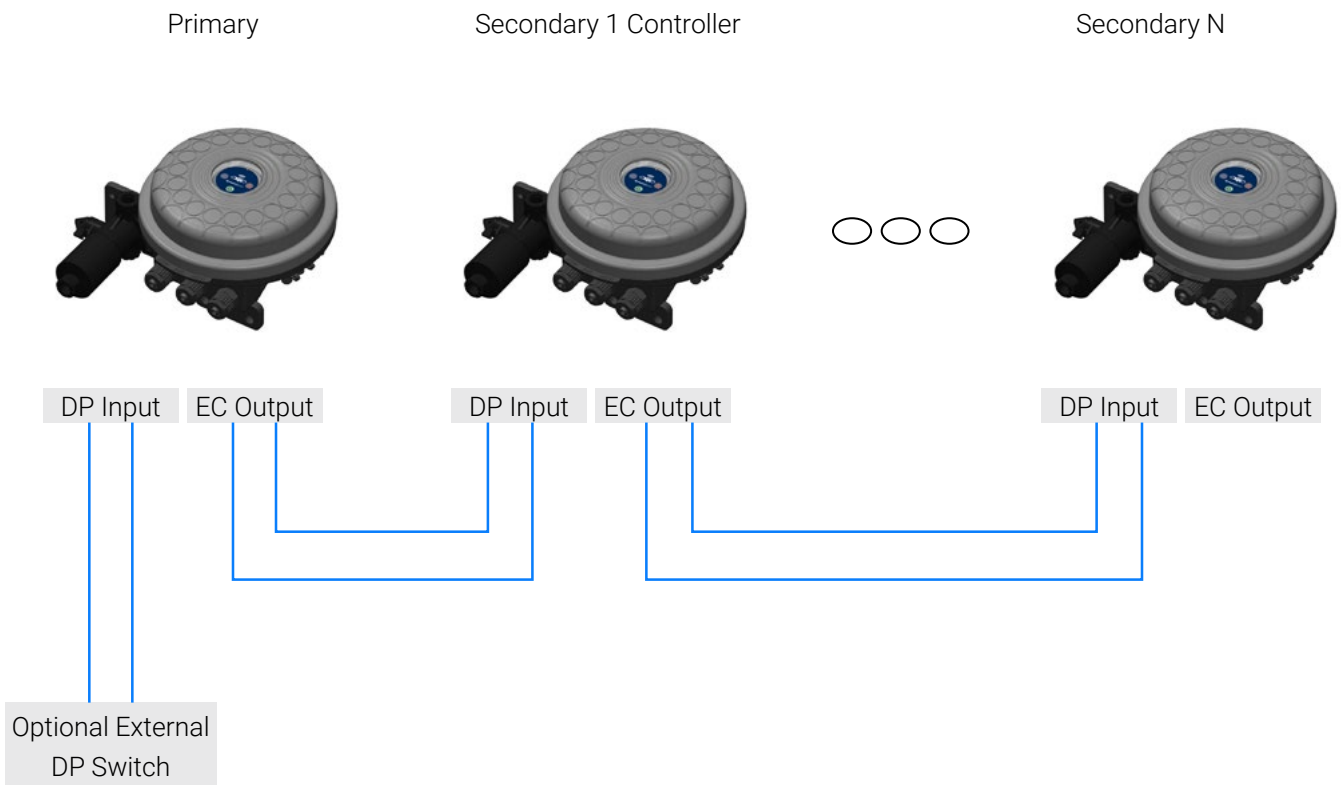

**Important Note:** Please make sure that the DP delay in the chained controllers (Secondary controllers) is set to no more than 5 seconds. This ensures proper transition from the last filter in the first controller to the first filter in the next controller.



# Connection Instructions

The connecting process has two stages; Stage 1: wires connection. Stage 2: setting the AlphaDisc™ BLE App for chained operation.

## STAGE 1: WIRES CONNECTION

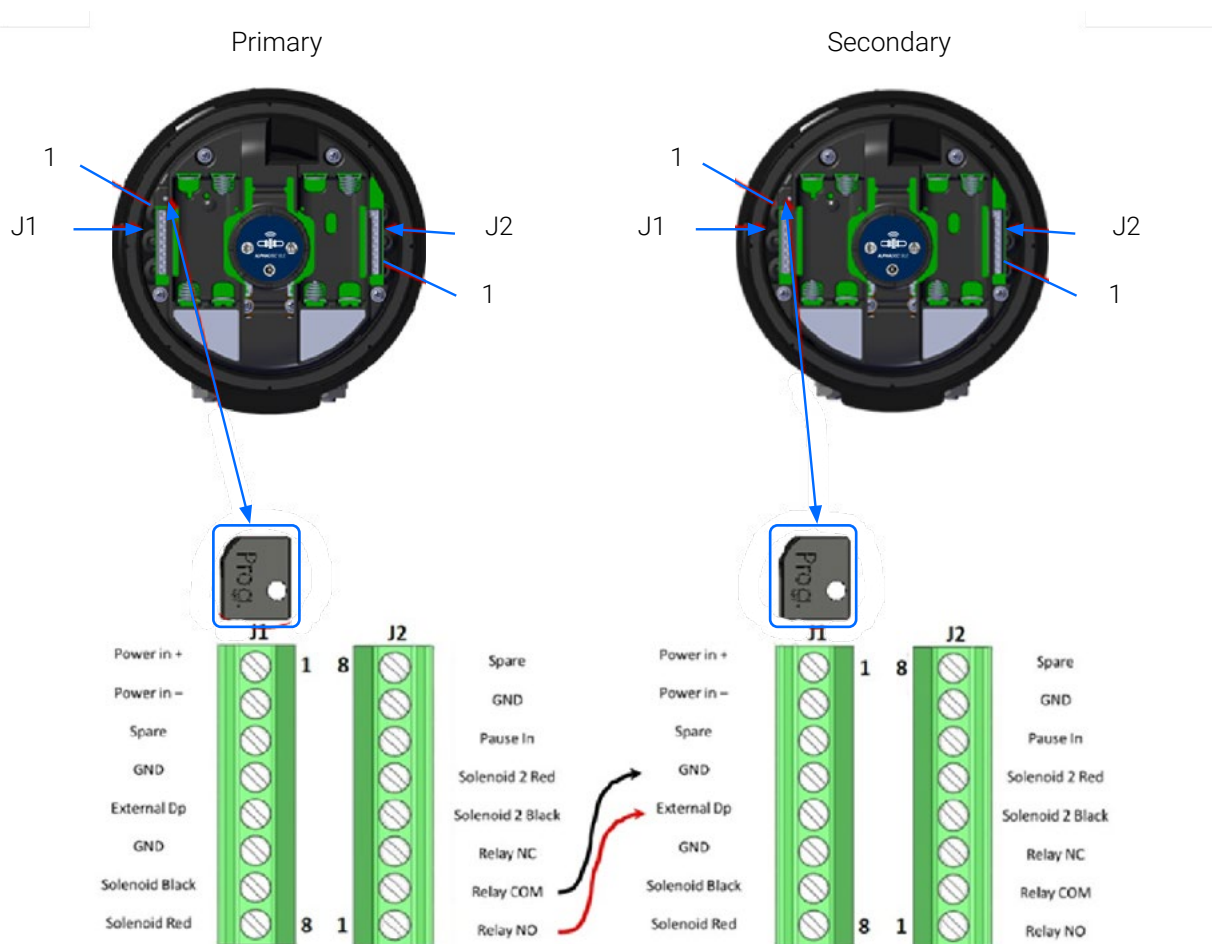

1. Connect between the Primary controller's NO relay output and the Secondary controller's external DP input. Important: For your safety and in order to avoid damaging the controller, remove the batteries before starting the wiring process.
2. Make sure that the wires' gauge (the diameter of the cable) used is similar to the solenoid wires' gauge (~4 mm). This is critical for maintaining the IP65 rating of the controller (dust tight and protected against water projected from a nozzle).

## STAGE 2: SETTING THE APPLICATION

To connect the AlphaDisc™ BLE App to the Primary controller, perform the following:

- Click the Settings icon on the top right of the home screen.
- Scroll down through the Settings screen.
- Select Technician Settings.
- Enter the password.
- Select Mode of Operation.
- Click on the current status of the controller (generally set to «Controller»)
- Under Choose Mode, select Primary mode for the current controller.

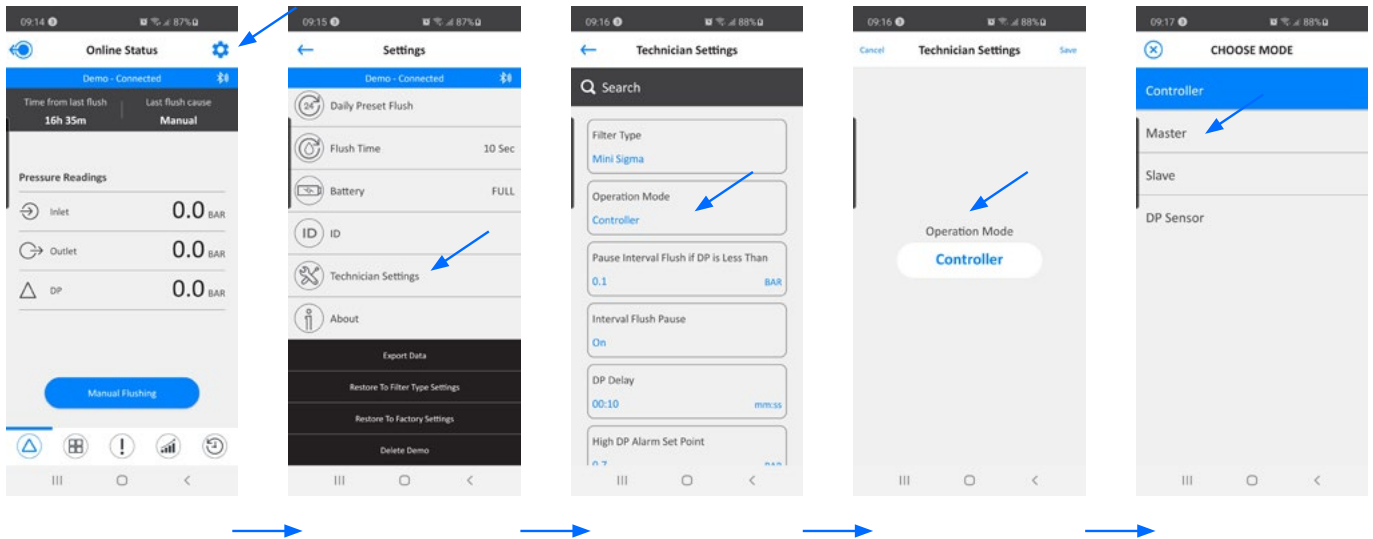

To change from Primary controller to Secondary controller, perform Steps A-F as above, and under Step G, select Secondary mode.

Check the controller's operation by starting a flush cycle through the application or by the controller's MANUAL FLUSHING button.

## Annex A. Chaining AlphaDisc™ BLE Controllers

### GENERAL

The AlphaDisc™ BLE system is powered by 4X1.5V AA consumer alkaline batteries (non-rechargeable, safety approved) and/or by external safety approved external DC power supply 7-14VDC, max 1A (not provided with

### SAFETY FIRST

When connecting the external power supply

- Make sure to comply with all the general and local regulations and standards required for connecting an indoor / outdoor external power source.
- All external connections must be done by an authorized electrician with qualifications to perform this type of work.

### TYPE OF ADAPTOR (NOT SUPPLIED BY NETAFIM)

- The adaptor should be a standard DC adaptor that supplies 7-14 VDC at its output connection.
- The system must be protected by a max 1A external fuse and it must use a minimum of 22 AWG wires.

## CONNECTIONS AND CONNECTION DRAWING

- ✓ The DC output of the adaptor should be connected to the J1 terminal strip of the controller to the: Power In (+) and Power In (-) connectors.
- ✓ For backup during power outages, the batteries may be left in place within the controller.
- ✓ DO NOT USE RECHARGEABLE BATTERIES!

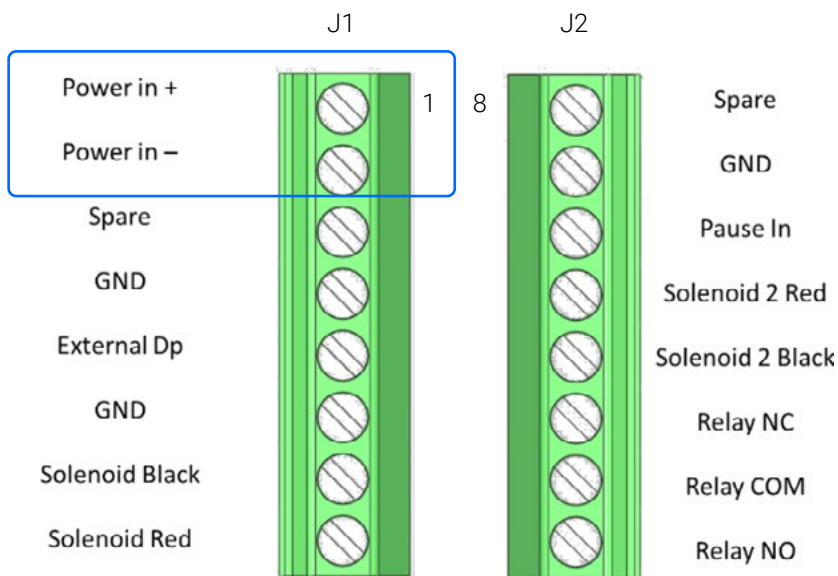

# Netafim Limited Warranty

This certificate applies to Netafim Ltd. ("Netafim") products purchased by you (the "Buyer") from Netafim unless specifically agreed otherwise in writing by Netafim. This Warranty extends only to the original purchaser, and is not transferable to anyone who subsequently purchases, leases, or otherwise obtains the product from the original purchaser.

Netafim hereby warrants that the products are and will be free from defects in material and workmanship under normal use and service. Netafim warrants that it will correct manufacturing defects in the products, in accordance with the conditions set out in this Warranty.

This Warranty is enforceable for a period of 12 months after the date upon which the products were delivered (the "Warranty Period").

In the event that during the Warranty Period the Buyer discovers a defect in material and/or workmanship in any product or part (the "Defective Product"), it shall submit a written complaint to Netafim using Netafim's standard Buyer Complaint Form. For the receipt of the Buyer Complaint Form, the submission of the complaint or any questions please contact your service representative.

Upon written demand by Netafim the Buyer shall return the Defective Product - or a sample thereof - to Netafim, at Netafim's cost. If the Buyer ships any such Defective Product, Netafim suggests the Buyer package it securely and insure it for value, as Netafim assumes no liability for any loss or damage occurring during shipment. Provided however that in the event Netafim determines that this Warranty does not apply to such product, Buyer shall promptly reimburse Netafim for such cost (including freight and customs). Any returned product or part must be accompanied by the Warranty certificate and the purchase invoice. It is clarified that the Buyer may not return the Defective Product unless such return was coordinated and approved by Netafim in advance.

Netafim's obligation under this Warranty shall be limited to, at Netafim's option, the repair or exchange, free of charge, of the product or any part which may prove defective under normal use and service during the Warranty Period. The provision of a repair or replacement of a product during the Warranty Period will result in an extension of the Warranty Period by an additional period of 12 months, provided that the total accumulated Warranty Period shall in any event be no more than 18 months from the date upon which the products were delivered.

This Warranty is valid on the condition that the products are installed according to Netafim's instructions as expressed in Netafim's instruction manuals and according to the technical limitations as stipulated in Netafim's literature or as stated by a representative of Netafim.

This Warranty will not apply to damaged or defective products resulting from or related to:

Fire, flood, power surges or failures or any other catastrophe and/or unforeseen occurrence, such as but not limited to those for which the Buyer is customarily insured for, or any force majeure events;

Fault, abuse or negligence of the Buyer;

Intake water not meeting the agreed standards, as set forth in a written document, approved by Netafim, or improper storage;

Improper or unauthorized use of the product or related parts by the Buyer, including Buyer's failure to operate the product in conformity with the recommendations and instructions of Netafim, as set forth in Netafim's manuals and other written materials, the operation of the product other than by a trained and qualified operator, or improper installation of the product by a third party not authorized by Netafim;

Performance by the Buyer of maintenance or operation other than in conformity with the recommendations and instructions of Netafim, or other than in accordance with procedures defined in the literature supplied for products (including the timely replacement of requisite parts), and for services provided other than by a trained and qualified advanced operator; or

Any alteration, modification, foreign attachment to or repair of the products, other than by Netafim or its authorized technical representatives.

In no event shall Netafim be liable to the Buyer or any third party for any damages to property, or for any intangible or economic loss, including loss of profits, loss of customers or damage to reputation, for any damages, including indirect, special, consequential damages, or punitive damage arising out of or in connection with this Warranty, or arising out of or in connection with the product's performance or failure to perform, even if it has been advised of the possibility of such damages.

Netafim will be excused for failure to perform or for delay in performance hereunder if such failure or delay is due to causes beyond its reasonable control or force majeure preventing or hindering performance.

This Warranty set forth herein is the only contractual warranty given by Netafim and is provided in lieu of any other warranties created by any documentation, packaging or otherwise.

Netafim makes no warranty whatsoever in respect to accessories or parts not supplied by Netafim. In the event that Netafim is required to correct a Defective Product or product not covered by this Warranty, it will do so solely in consideration for additional fees.

The parties will actively endeavor to amicably settle any dispute arising between them. In the event that the parties are unable to reach an equitable settlement of such dispute, any claim or lawsuit related to the Warranty, its validity execution, its performance be brought before only the courts of Tel-Aviv, Israel. Israeli law will govern the Warranty, to the exclusion of any conflict of law rules.



Manufacturer  
Amiad Water Systems Ltd.  
D.N. Galil Elyon 1, 1233500, Israel.  
Tel: +972 4690 9500 | Fax: +972 48141159 | Email: info@Netafim.com



European Authorised Representative for CE  
Obelis s.a. Bd Général Wahis 53, 1030 Brussels, Belgium.  
Tel: +(32) 2732 5954 | Fax: +(32) 27326003 | Email: mail@obelis.net

EU Declaration of Conformity <https://www.amiad.com/certificatesDownload.asp>



01-0920-ALPHA-PUG-001-EN

**GROW MORE WITH LESS™**



[www.netafim.com](http://www.netafim.com)