

INSTALLATION GUIDE

NMC-PRO IRRIGATION



© COPYRIGHT 2011, NETAFIM test

NO PARTS OF THIS PUBLICATION MAY BE REPRODUCED, STORED IN AN AUTOMATED DATA FILE OR MADE PUBLIC IN ANY FORM OR BY ANY MEANS, WHETHER ELECTRONIC, MECHANICAL, BY PHOTOCOPYING, RECORDING OR IN ANY OTHER MANNER WITHOUT PRIOR WRITTEN PERMISSION OF THE PUBLISHER.

ALTHOUGH NETAFIM TAKES THE GREATEST POSSIBLE CARE IN DESIGNING AND PRODUCING BOTH ITS PRODUCTS AND THE ASSOCIATED DOCUMENTATION, THEY MAY STILL INCLUDE FAULTS.

NETAFIM WILL NOT ACCEPT RESPONSIBILITY FOR DAMAGE RESULTING FROM THE USE OF NETAFIM'S PRODUCTS OR THE USE OF THIS MANUAL.

NETAFIM RESERVES THE RIGHT TO MAKE CHANGES AND IMPROVEMENTS TO ITS PRODUCTS AND/OR THE ASSOCIATED DOCUMENTATION WITHOUT PRIOR NOTICE

VERSION 3.07 REV 1.8 110045

Table of Contents

1	General Instructions	9
1.1	Basic Requirements for On-Site Preparation	9
1.2	Frequency Inverters	9
1.3	General Dimensions	9
2	Unpacking and Mounting	10
2.1	Unpacking	10
2.2	Controller Mounting	10
3	POWER SUPPLY WIRING	11
3.1	Main Power Wiring	11
3.2	Power Supply Options	13
3.2.1	Power Supply Option A	13
3.2.2	Power Supply Option B	13
3.3	Cold Start	14
3.4	Set Language, Time and Date	15
3.5	Electric Test	15
3.6	Firmware Upgrade	16
3.6.1	Accessing the Application	16
3.6.2	Running the Application	17
4	ELECTRICAL INSTALLATION	18
4.1	Input/Output	18
4.1.1	Layout	18
4.1.2	I/O Card Layout	19
4.1.3	Controller Hardware Verification	20
4.1.4	Input/Output Wiring	20
4.2	Output Terminal	21
4.2.1	Analog Output Card	21
4.2.2	24 VAC Connection	23
4.2.3	Dry Contact Card	24
4.3	Input Terminals	25
4.3.1	Wiring	25
4.3.2	Analog Input Card	27
4.4	Expansion Unit Connection: Card Connection Options	31
4.4.1	Option A: RS-485 Connection	32
4.4.2	Option B: RS-232 Direct Connection	34
4.4.3	Option C: RS-232 via Line Driver Connection	35
4.4.4	Wrong Relay Connection	36
4.4.5	Expansion Unit	36

CONTENTS

4.4.6	PC and Inter-Controller Communication	37
4.5	Controller Setup	40
4.5.1	Start-Up	40
4.5.2	Hardware Checklist	40
4.5.3	Output Definition	41
4.5.4	Digital Input Definition	41
4.5.5	Analog Input Definition	42
4.5.6	Analog Output Definition	42
4.6	Controller Test Procedure.....	43
4.6.1	Test Relays.....	43
4.6.2	Digital Input Test.....	44
4.6.3	Analog Input Test	44
4.6.4	Analog Output Test.....	45
4.7	System Configuration Procedure.....	46
4.7.1	Device Delay Configuration.....	47
4.7.2	Pump Station Configuration	48
4.7.3	Valve Configuration	48
4.7.4	Valve Flow Rate Configuration.....	48
4.7.5	Water Meter Configuration	49
4.7.6	Dosing Channel Configuration	49
4.7.7	Analog Dosing Channel Configuration	50
4.7.8	Dosing Configuration	50
4.7.9	EC/PH Sensor Range	51
4.7.10	History Resolution	51
4.7.11	System Nutrigation™ Check	52
4.7.12	Data Plug.....	54
5	PROGRAM menu.....	55
5.1	Irrigation.....	55
5.1.1	Setting Irrigation that is Longer than 24H.....	59
5.2	Influence Program	59
5.2.1	Using the Influences	59
5.2.2	Setting the Influences	59
5.3	Water Run Time.....	65
5.4	Dosing.....	66
5.4.1	Dosing Program.....	66
5.4.2	Dosing Injection Methods	67
5.5	Ext. Condition	68
5.5.1	Defining Analog Sensors.....	69

CONTENTS

5.6	Agitator.....	70
5.7	Selector.....	71
5.8	Filter Flushing.....	71
5.9	Cooling.....	72
5.10	Misting.....	74
5.11	Water Heating.....	75
6	MANUAL OPERATION Menu	76
6.1	Irrigation Pause.....	76
6.2	Start/Stop Program.....	76
6.2.1	Start/Stop Valve.....	77
6.3	Filter Flushing.....	77
7	ALARM MENU	78
7.1	Alarm Reset.....	78
7.2	History.....	79
7.3	Alarm Definition.....	79
7.4	Alarm Setting.....	81
7.4.1	Analog Output Alarm Generation.....	81
7.5	EC/pH Alarm Definition.....	82
7.6	EC/pH Alarm Setting.....	83
7.7	Radio Sys. Alarm Definition.....	83
7.8	Radio Sys. Alarm View.....	84
7.9	SMS Subscription.....	84
8	HISTORY MENU	85
8.1	Irrigation Log.....	86
8.2	RAD. / VPD Sum & Drain Log.....	86
8.3	Uncompleted Irrigation.....	87
8.4	Uncompleted Programs.....	88
8.5	Daily Irrigation.....	88
8.6	Irrigation Accumulation.....	89
8.7	AUX Meter Accumulation.....	89
8.8	Accumulation Reset.....	89
8.9	Filters.....	90
8.10	Cooling.....	90
8.11	Sensors Log.....	91
8.12	Event Log.....	91
8.13	System Log.....	91
9	TEST MENU	92
9.1	Relays.....	92

CONTENTS

9.2	Digital Input.....	93
9.3	Analog Input.....	94
9.4	Temperature	94
9.5	Humidity.....	95
9.6	Hardware Check List	95
9.7	Analog Output Test.....	96
10	Setup	97
10.1	Time & Date.....	98
10.2	System Setup	98
10.3	Temperature Calibration	101
10.4	Humidity Calibration.....	101
10.5	EC/pH Calibration	102
10.5.1	Calibration of the EC/pH Monitor Transmitter	102
10.5.2	EC/pH Transmitter Monitor & NMC-Pro Correlation	104
10.6	Pressure Calibration	104
10.7	Weather Station Calibration.....	104
10.8	Sensors Logging.....	105
10.9	Write to Data Plug.....	105
10.10	Read from Data Plug	106
10.11	Edit SMS Phonebook.....	107
10.12	SMS Setup.....	107
10.13	SMS Personal Message	108
11	CONFIGURATION MENU	109
11.1	Device Delay Configuration	110
11.1.1	Example of Device Startup & Shutdown Order	110
11.1.2	Example of Stagger Valve Delay – Multiple Shifts	111
11.2	Pump Station Configuration.....	112
11.3	Valve Configuration	113
11.4	Valve Flow Rate.....	114
11.5	Water Meter	115
11.6	Dosing Channel Configuration.....	116
11.6.1	Calibrating the Analog Dosing Valve.....	117
11.7	Dosing Configuration	119
11.8	EC Pre-Control Configuration.....	120
11.9	Drainage Configuration.....	120
11.10	System Pressure Configuration.....	121
11.11	EC/pH Range Definition.....	121
11.12	Pressure Sensor Range Definition	121

CONTENTS

11.13	Cooling Configuration	122
11.14	Misting Configuration	122
12	INSTALLATION Menu	123
12.1	Device Layout	123
12.2	Device List	125
12.3	Digital Input	125
12.4	Analog Input 1-2	126
12.5	Analog Output	129
12.6	Hardware Checklist	129
13	CONTROLLER ADVANCED SETTINGS	130
13.1	Pump Station Configuration	130
13.2	Multiple Water Meters	131
13.2.1	Option A - Standard Use/Measurement	131
13.2.2	Option B - Multiple Water Sources	131
13.3	Drain Meter Measurement	132
13.3.1	Drainage Timing Option A	132
13.3.2	Drainage Timing Option B	133
13.4	Various Dosing Channel Configurations	134
13.4.1	Method 1	134
13.4.2	Method 2	134
13.4.3	Method 3	135
13.5	Dosing Configuration	135
13.6	Dual EC/pH Sensors	136
13.7	Hot Keys and Status Screens	138
13.8	Operation Mode	138
14	APPENDIX A – NMC-PRO PARTS LIST	140
15	APPENDIX B – TROUBLESHOOTING	141
15.1	Controller Malfunction	141
15.2	Burnt Fuse - In Case of Voltage	141
16	APPENDIX C – REPLACEMENTS AND ADDITIONAL INSTALLATIONS	142
16.1	Installing a 24 VAC Output Card	142
16.2	Removing a Card	143
16.3	Adding a Dry Contact Output Card	143
16.4	Adding an Input Card	144
16.5	LCD & Keyboard Replacement	145
16.5.1	NMC-PRO: Old LCD & Keyboard Replacement	145
16.5.2	NMC-PRO: New LCD & Keyboard Replacement	146
17	APPENDIX D - SENSOR INSTALLATION AND DEFINITION	147

CONTENTS

17.1	EC – pH Sensor Connection	147
17.1.1	EC Sensor Calibration	148
17.1.2	pH Sensor Calibration	149
17.1.3	Pro pH Calibration	150
17.2	Measuring Box Connection	151
17.3	Humidity Sensor Definition	152
17.3.1	Outside Temperature/Humidity Sensor Connection.....	153
17.3.2	Sensor Definition	153
17.4	Pyranometer Connection – Netafim1	154
17.5	Radiation Sensor Definition	155
17.5.1	Radiation Sensor Configuration – Netafim	155
17.5.2	Radiation Sensor Connection – Davis.....	156
17.6	Pressure Transducer Connection.....	157
17.6.1	Analog Pressure Sensor Definition	158
17.7	Wind Direction Connection	159
17.7.1	Wind Direction Sensor Definition.....	160
17.7.2	Wind Speed Digital Input Definition.....	160
17.8	Sensor and Cable Specifications.....	161
18	APPENDIX E- TECHNICAL SPECIFICATIONS	162
18.1	Technical Specifications	162
18.2	Controller Components.....	162
18.2.1	Keyboard & Display.....	162
18.2.2	CPU	163
18.2.3	Power Supply	163
18.2.4	Digital Input.....	165
18.2.5	Analog Input	165
18.2.6	Analog Output.....	165
19	APPENDIX F - MAIN MENU TREE	166
20	WARRANTY	167

1 GENERAL INSTRUCTIONS

- Installation should be performed by authorized technicians only.
- Verify that field components are working properly.
- Apply all safety regulations.
- Do not apply force or pressure on components during the installation procedure.
- Refer to your supervisor if problems occur during installation procedure.

1.1 Basic Requirements for On-Site Preparation

- Verify power source between 115 VAC or 220 VAC or 12VDC. (Australia & New Zealand 240 VAC±5%).
- Verify grounding connection $< 10\Omega$.
- Environment temperature between $(-10^{\circ}\text{C} / 14^{\circ}\text{F})$ - $(+60^{\circ}\text{C} / 140^{\circ}\text{F})$.
- Verify protection from damaging climate conditions.

1.2 Frequency Inverters

Frequency inverters can cause severe electrical and electromagnetic interference. Therefore, when employing a frequency inverter, it is critical that you carefully follow the manufacturer's installation instructions.

In particular verify:

- that the cable shielding between the inverter and any motor meets industry standards
- proper grounding of the inverter's chassis and motor power cable
- proper grounding of low voltage cable shield wire
- that the controller and inverter cables are kept in separate conduits or wire bundles

1.3 General Dimensions



UNPACKING AND MOUNTING

2 UNPACKING AND MOUNTING

- Unpacking
- Main Power Wiring

2.1 Unpacking



2.2 Controller Mounting



3 POWER SUPPLY WIRING

- Main Power Wiring, page 11
- Power Supply Options, page 13
- Cold Start, page 14
- Set Language, Time and Date, page 15
- Electric Test, page 15

3.1 Main Power Wiring

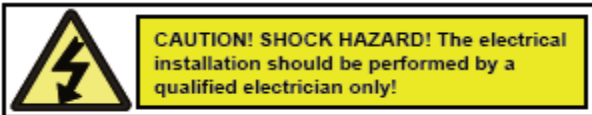

1

SWITCH OFF Main power

VERIFY grounding connection <math>< 10\Omega</math>



2

LOOSEN Gland screw

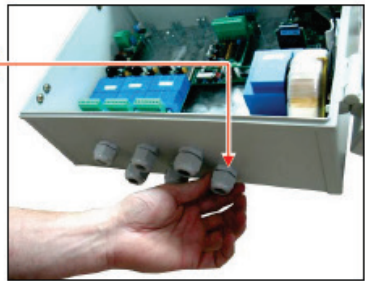

3

INSERT Feeding cable into Gland cover

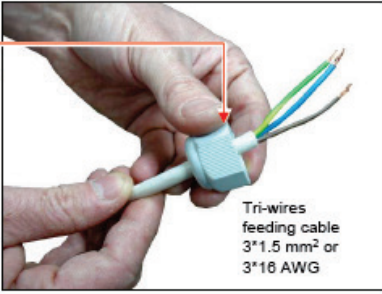

Tri-wires feeding cable
3*1.5 mm² or
3*18 AWG

NOTE: There are two wiring options according to the sticker attached to the side wall of the controller:
115 VAC 50-60Hz or 230VAC 50-60 Hz



PRODUCT NAME	
NMC PRO LARGE PLASTIC BOX	
PART NO.:	SERIAL NO.:
P-NMCP-R-L-V2	
VOLTAGE	
230VAC ~50/60Hz 0.7A	
CAUTION! Risk Of Electrical Shock Do Not Open	
P-SS	
CE	

ELECTRICAL INSTALLATION

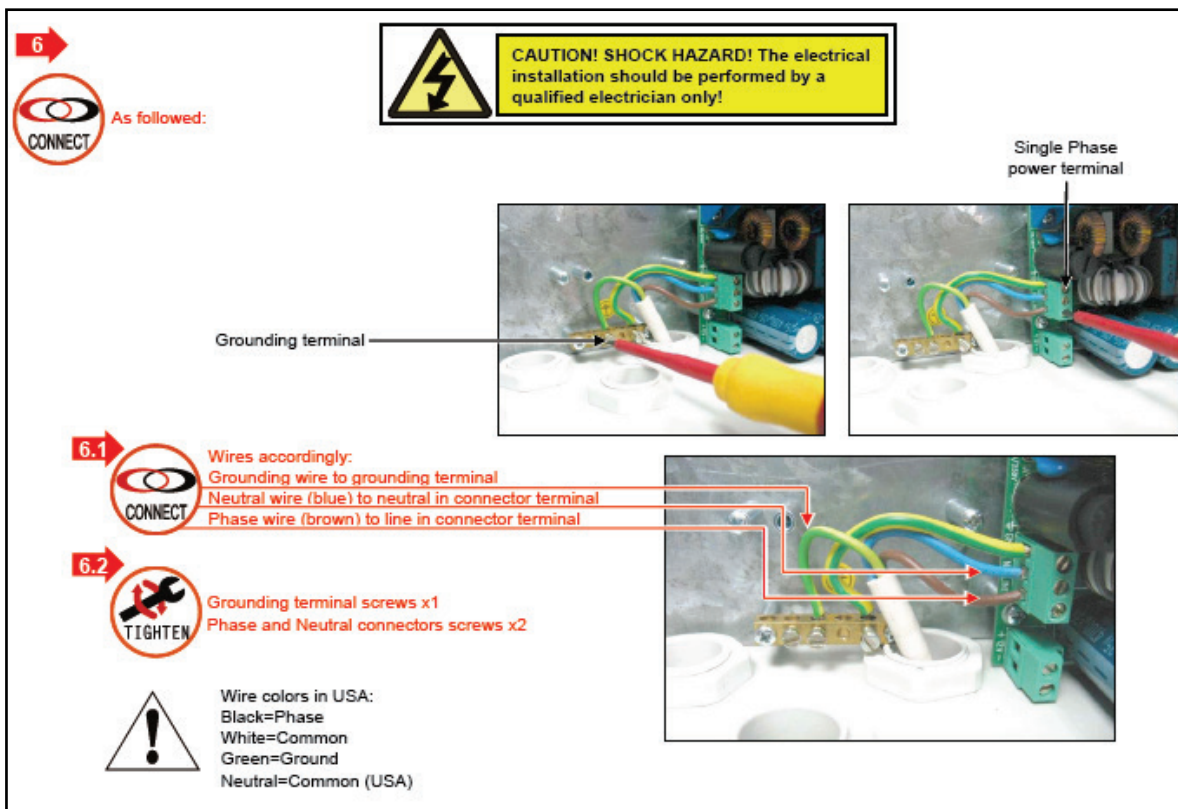

ELECTRICAL INSTALLATION

3.2 Power Supply Options

- Power Supply Option A
- Power Supply Option B

3.2.1 Power Supply Option A

In case of remote consumers or low voltage on the main power, there is an option to use a 29 VAC supplier as shown:

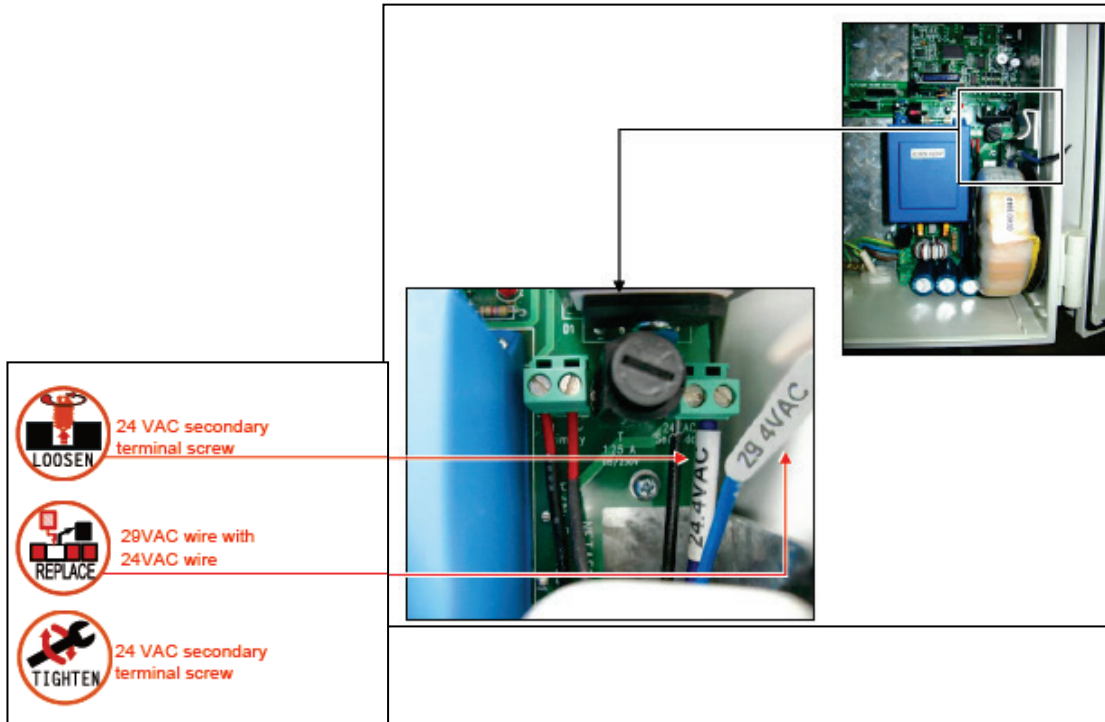

3.2.2 Power Supply Option B

In case of voltage discrepancy or fluctuation in the main voltage, there is an option of connecting the system to an independent supplier and keeping the main voltage as power source for the output devices as shown:

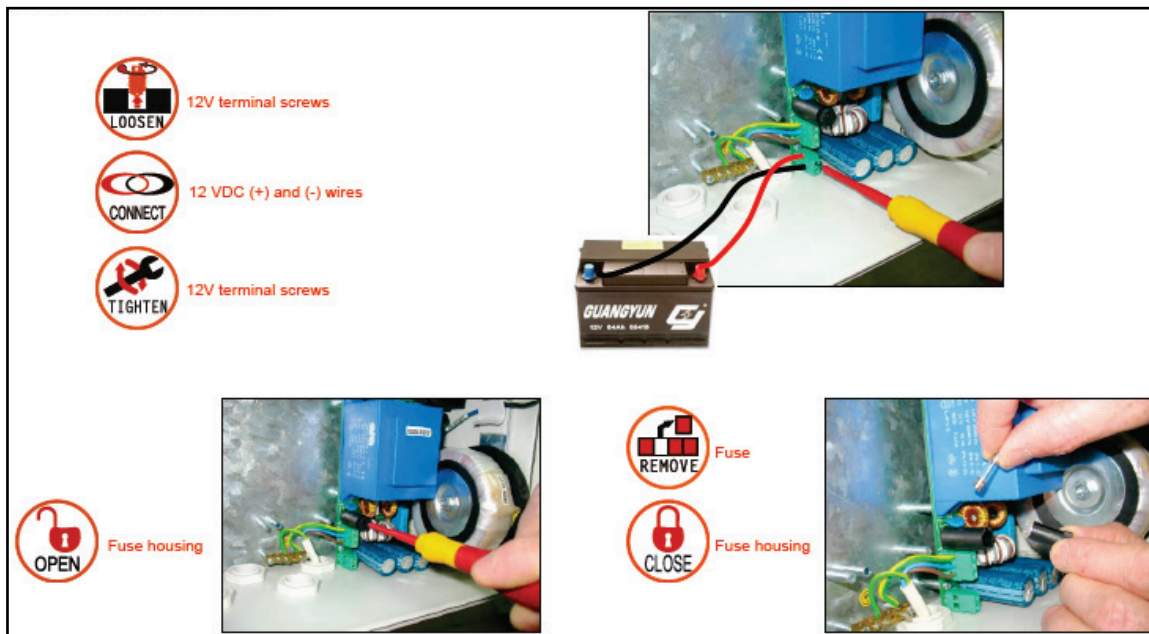

ELECTRICAL INSTALLATION

3.3 Cold Start

Note: To perform a **cold start** or **firmware upgrade**, the controller must be in the “**Technician**” mode; refer to the **CONTROLLER ADVANCED SETTINGS - Operation Mode**.

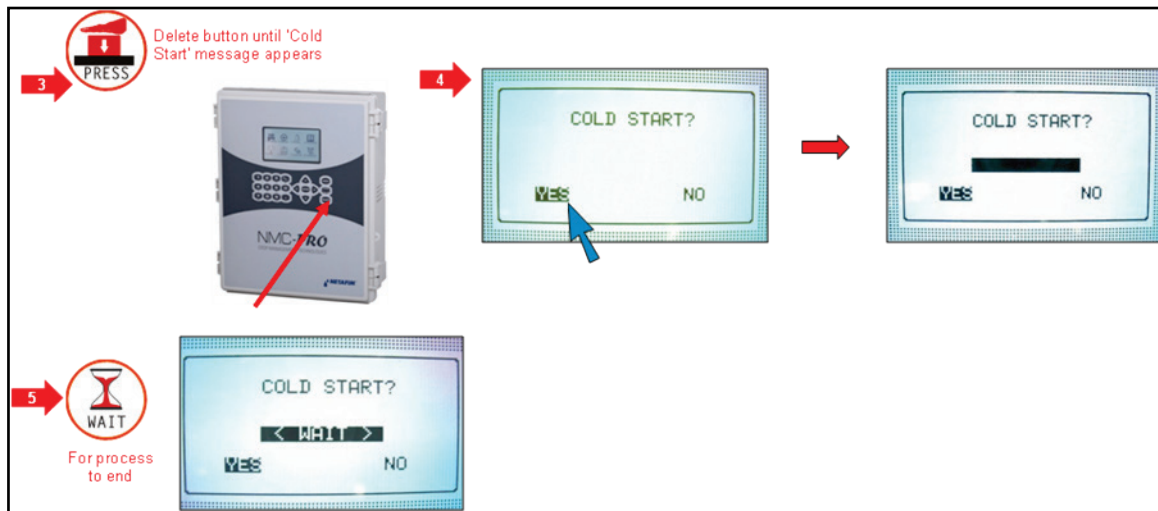
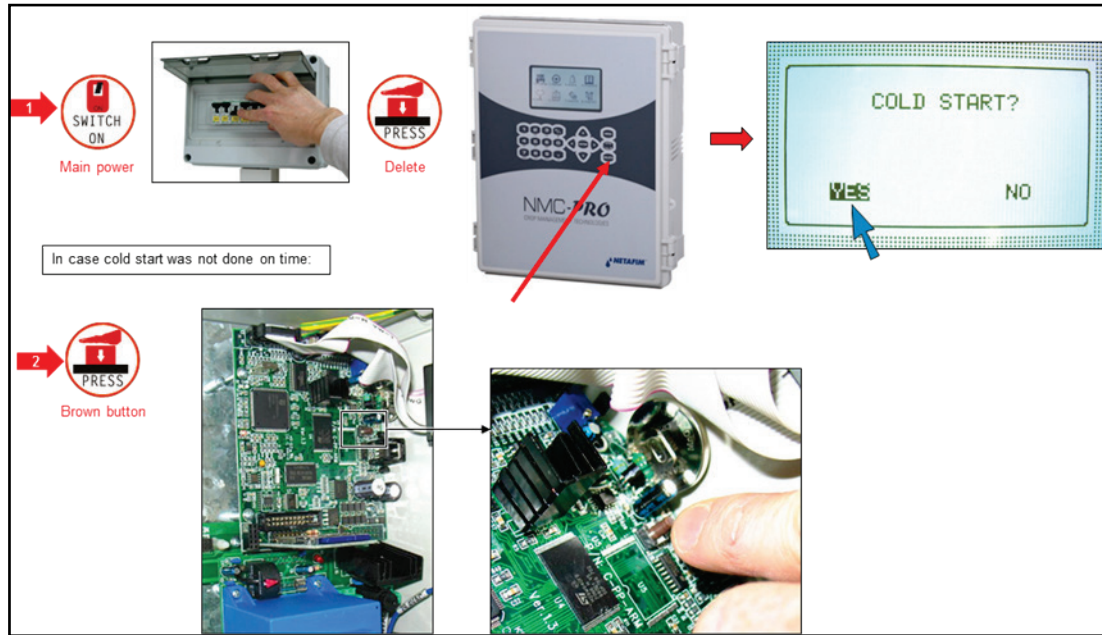

ELECTRICAL INSTALLATION

3.4 Set Language, Time and Date

1 "MENU" on touch pad

2 **SELECT**

- ⇒ Select desired language
- ⇒ Select Temp. and Vol. unit (USA: Temp.=°F, Vol.=Gallon)
- ⇒ "1. Time & Date" in Setup menu and set

3

4

5

- ⇒ Define the Time (Currently)
- ⇒ Define today's Date
- ⇒ Define the End day time (refer to section 6.1)
- ⇒ Define the time frame for Irrigation based on VPD Sum (VPD Sum counter resets at each Start time)

Note: In any given menu, you can use arrow and ENTER keys on the touch pad to make a selection, or press the corresponding number and ENTER on touch pad as a short cut.

3.5 Electric Test

CAUTION! SHOCK HAZARD! The electrical installation should be performed by a qualified electrician only!

1 **PERFORM** Electrical test with Multimeter

2 **CHECK**

- ⇒ Phase to ground
- ⇒ Phase to neutral

ENSURE

Phase to ground results:
 Option 1- 220VAC± 10% (EUR, AFR)
 Option 2- 115VAC±10% (USA, MEX)
 Option 3- 240VAC±5% (AUS, NZ)

Phase to neutral results:
 Option 1- 220VAC± 10% (EUR, AFR)
 Option 2- 115VAC±10% (USA, MEX)
 Option 3- 240VAC±5% (AUS, NZ)

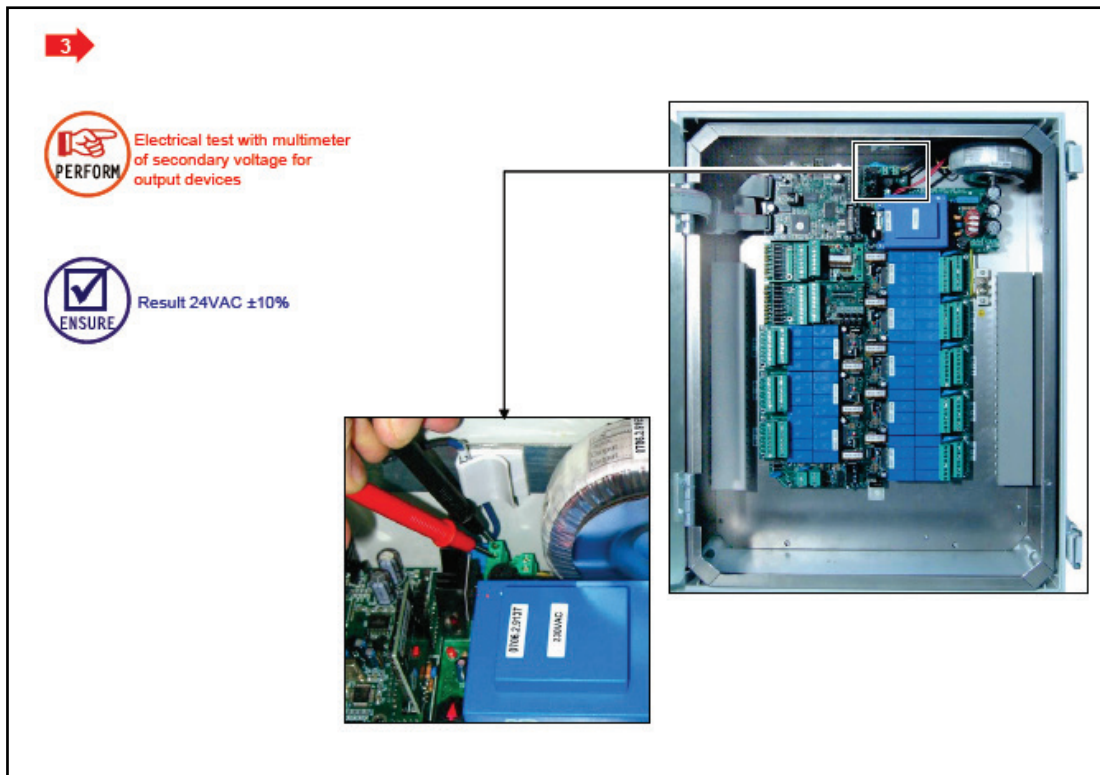

3.6 Firmware Upgrade

The Bootloader application enables installing or updating the system firmware. The application is menu based and simple to use and enables updating the firmware from an SD card.

Note: Verify that the card is in place before starting.

3.6.1 Accessing the Application

1. Press and hold the **Left** and **Down** arrow keys.
2. Turn on the unit.

In the screen that appears, enter the password: **38845**.

Note: If you enter the wrong password, an error message appears and the program goes to the Main Screen. Repeat the process.

3. Press **Enter**. The screen below appears.

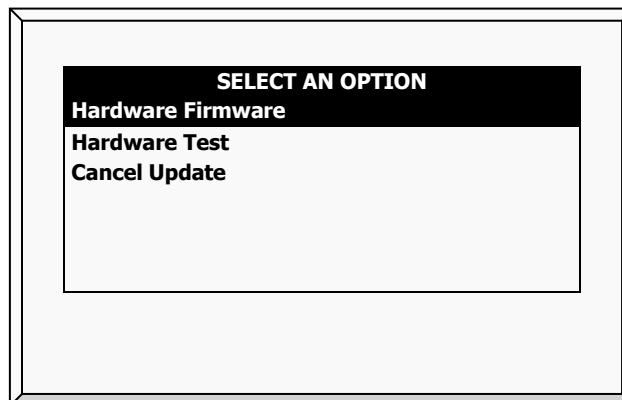

Note: Hardware Test is used for quality control only.

ELECTRICAL INSTALLATION

3.6.2 Running the Application

 **Note:** Pressing **Exit** or **ESC** takes you to the previous menu.

1. Select **Hardware Firmware**. The following screen appears (example only):

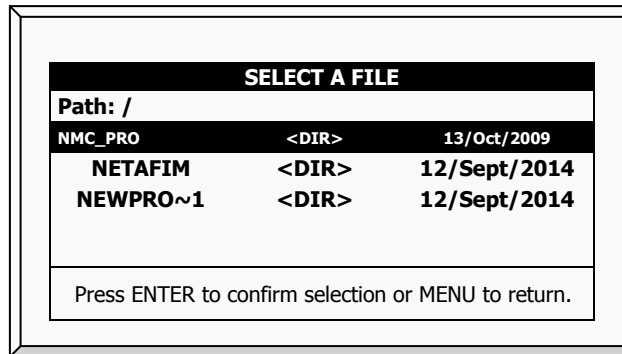

2. Select the required directory.

3. Press **Enter**.

The following screen appears:

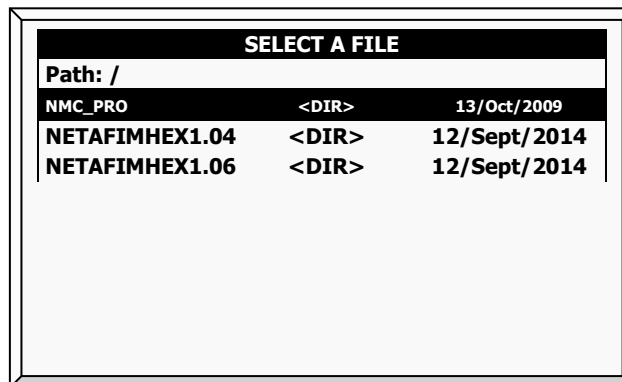

4. Select the required software version.

5. Press **Enter**.

6. A confirmation message appears. Select **Yes**.

7. Press **Enter**.

 **Note:** Do not turn the unit off during the update! If there is an interruption (for example a power outage), restart the process.

At the end of the process, the following screen appears (the version numbers are examples only):

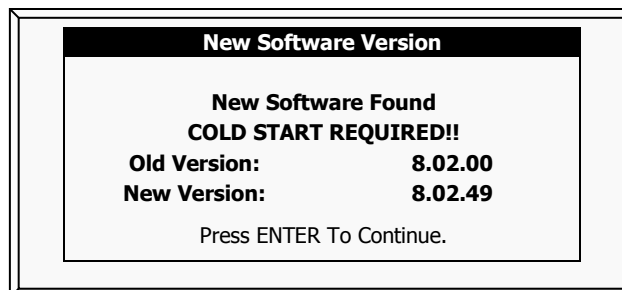

8. Press **Enter** and perform a **Cold Start**.

4 ELECTRICAL INSTALLATION

- Input/Output, page 21
- Output Terminal, page 21
- Input Terminals, page 25
- Expansion Unit Connection: Card Connection Options, page 31
- Controller Setup, page 40
- Controller Test Procedure, page 42
- System Configuration Procedure, page 45

4.1 Input/Output

- Layout, page 18
- I/O Card Layout, page 19
- Controller Hardware Verification, page 20
- Input/Output Wiring, page 20

4.1.1 Layout

The following diagram is an example setup of an NMC Pro board. Actual boards may differ.

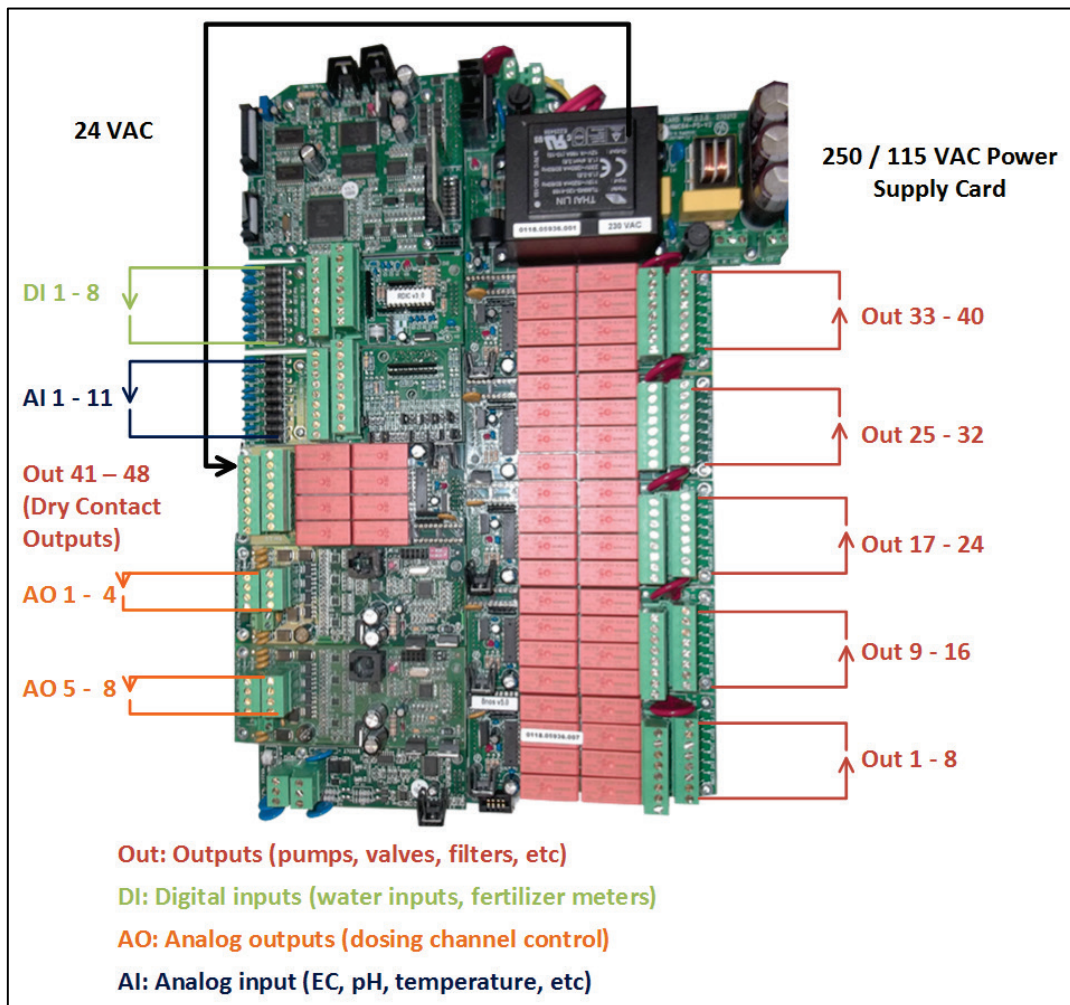

ELECTRICAL INSTALLATION

4.1.3 Controller Hardware Verification



⇒ "8. Install"
⇒ "6. Hardware checklist"

1



1. Program 2. Manual 3. Alarm 4. History
5. Test 6. Setup 7. Config 8. Install

2



INSTALLATION
1. DEVICE LAYOUT
2. DEVICE LIST
3. DIGITAL INPUT
4. ANALOG INPUT 1
5. ANALOG INPUT 2
6. ANALOG OUTPUT
7. HARDWARE CHECKLIST

3

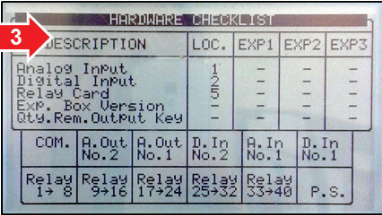

HARDWARE CHECKLIST					
DESCRIPTION	LOC.	EXP1	EXP2	EXP3	
Analog Input	1	-	-	-	
Digital Input	2	-	-	-	
Relay Card	-	-	-	-	
Exp. Box Version	-	-	-	-	
Qty. Rem. Output key	-	-	-	-	
COM.	A. Out No. 2	A. Out No. 1	D. In No. 2	A. In No. 1	D. In No. 1
Relay 1→ 8	Relay 9→16	Relay 17→24	Relay 25→32	Relay 33→48	P. S.

Legend

- COM.- Communication card location
- Relay - 24VAC or dry contact output
- R.U - Remote Unit output
- A.In - Analog input card
- D.In - Digital input card
- P.S - Power supply



Hardware OK



Main power



4.1.4 Input/Output Wiring

REMOVE

Wire Channel Cover



ROUTE

Wires through Wire Channel

CONNECT

Wires as shown

LOOSEN Screw as shown

INSERT Wire

ROUTE Wires:
Low terminal=command
High terminal=common

SCREW Until wire is locked inside bracket



REPEAT Perform the above steps for all wires

4.2 Output Terminal

- Analog Output Card
- 24 VAC Connection
- Dry Contact Card

4.2.1 Analog Output Card

- Analog Output Card Installation
- Analog Output Card Setup

4.2.1.1 Analog Output Card Installation

1. Verify the following before installing the cards:
 - ◆ NMC Pro Controller firmware is Version 3.7.02 or above
 - ◆ NMC Net Version: 4.07.18
 - ◆ NMC Air: NMC Air does not support NMC PRO Ver 3.7.02. Netafim will notify you when an updated version of NMC AIR is available.
2. Disconnect the controller from the power.
3. Install the analog cards in the slots indicated in I/O Card Layout, page 19.
4. Apply power; the NMC Pro will detect the new card(s).
5. In the screen that appears, select **YES**.



6. Go to the Installation Menu to confirm that the card is installed.

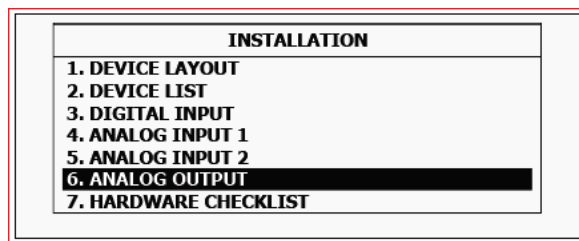

ELECTRICAL INSTALLATION

4.2.1.2 Analog Output Card Setup

To install the Analog Output Card (refer to the following diagrams):

- wire the card
- set the dipswitches

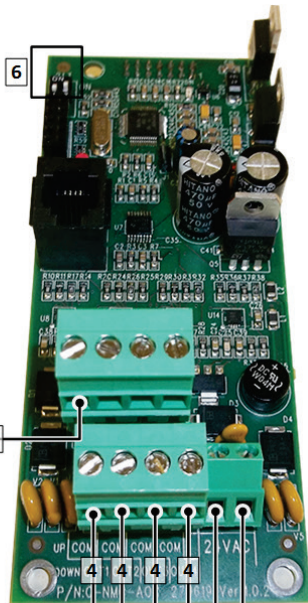

- 1 & 2: Voltage supply, 24 VAC (Red and Black wires)
- 3: COM Port (Yellow wire)
- 4: OUT Ports 1 – 4 (4 – 20 mA) (Blue wire)
- 5: Valve
- 6: Dipswitches (see below)

Note: Each card can support up to four valves. Connect each valve to a different Output; one COM port can support up to four devices.

- When using an analog dosing valve make sure the dosing valve selector is in the AUTO position.

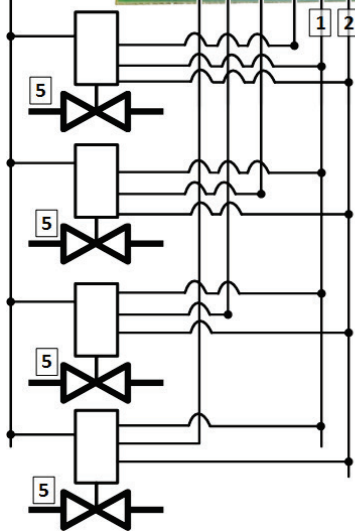
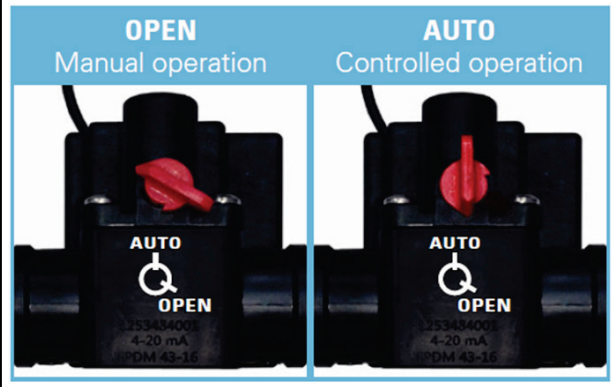

Use the dipswitches (#6 in the above illustration) to define a card as Card One or Card Two. This is needed to ensure that the Controller can properly manage analog output devices.

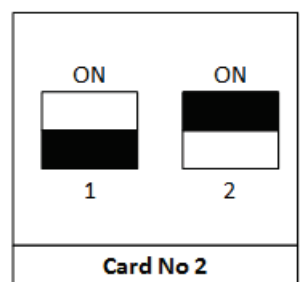
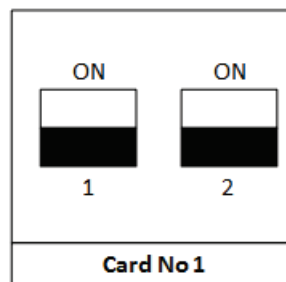

Refer to Analog Dosing Channel Configuration, page 50.

ELECTRICAL INSTALLATION

4.2.2 24 VAC Connection

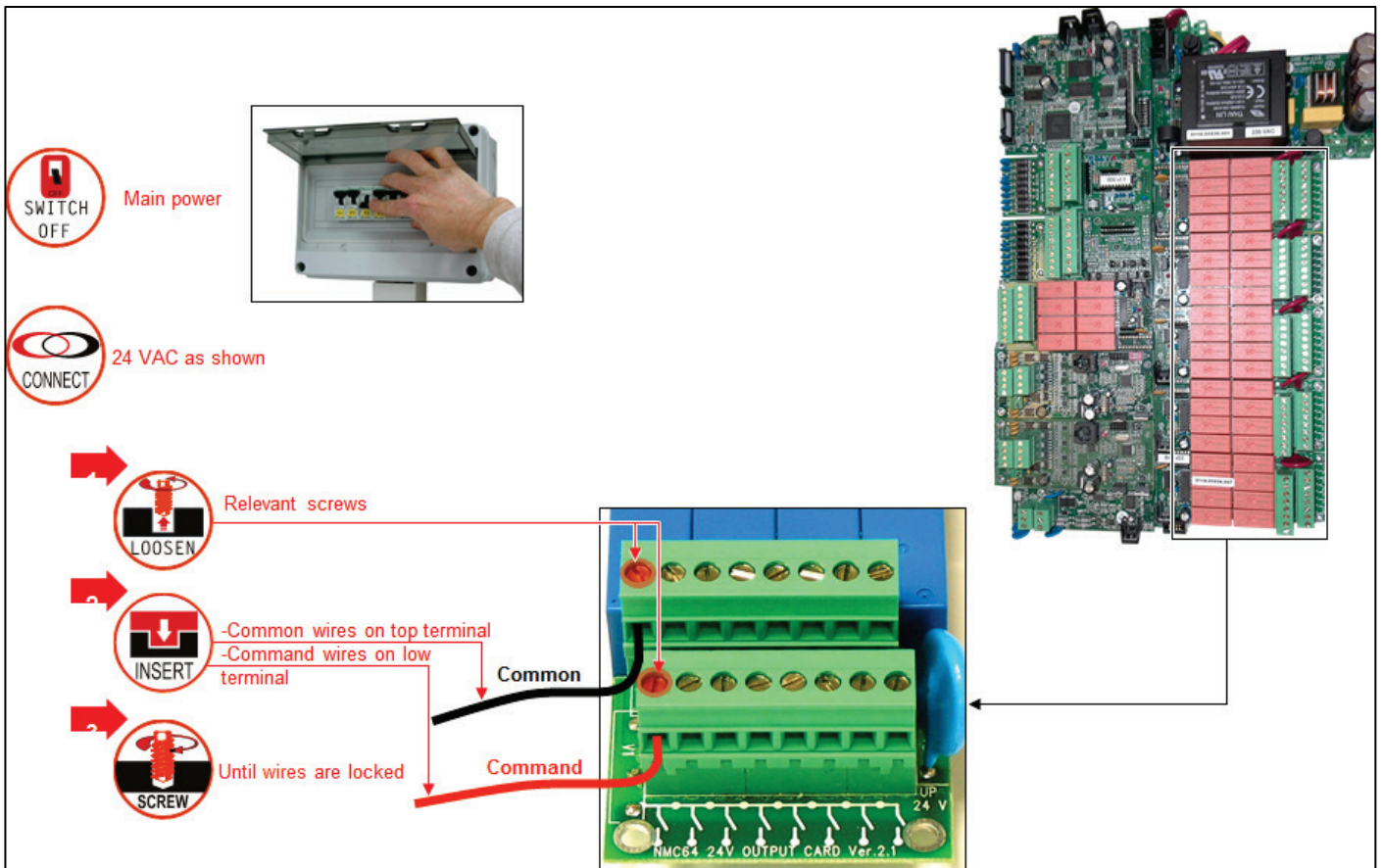

24VAC OUTPUT CARD CONNECTION- EXAMPLE

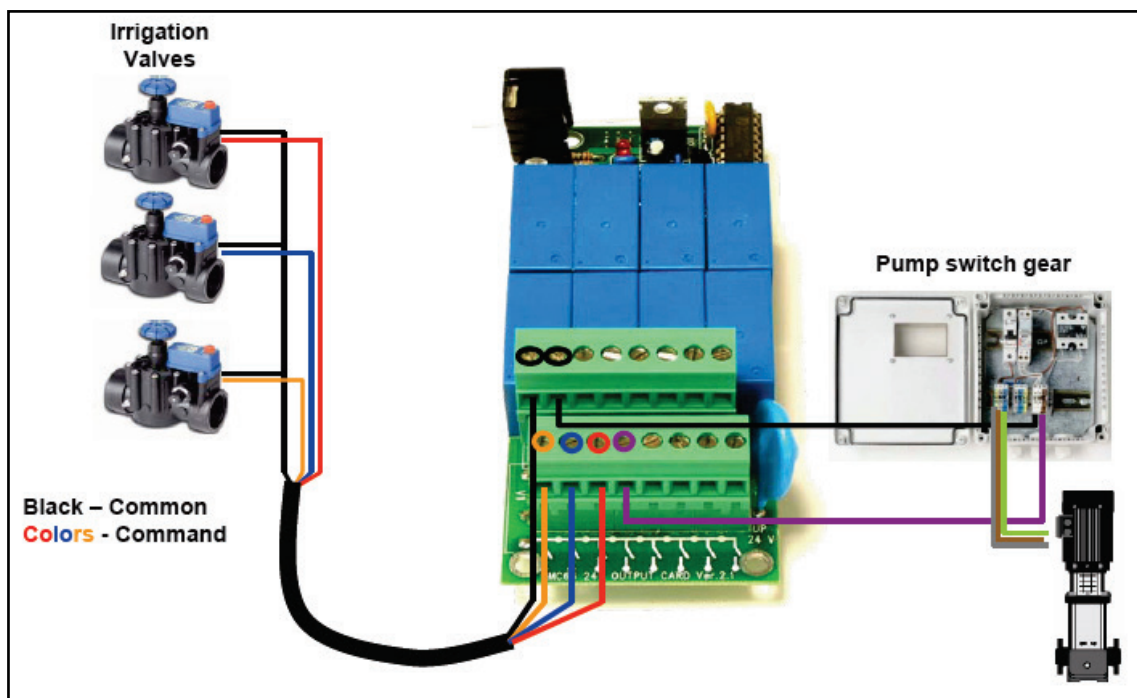

ELECTRICAL INSTALLATION

4.2.3 Dry Contact Card

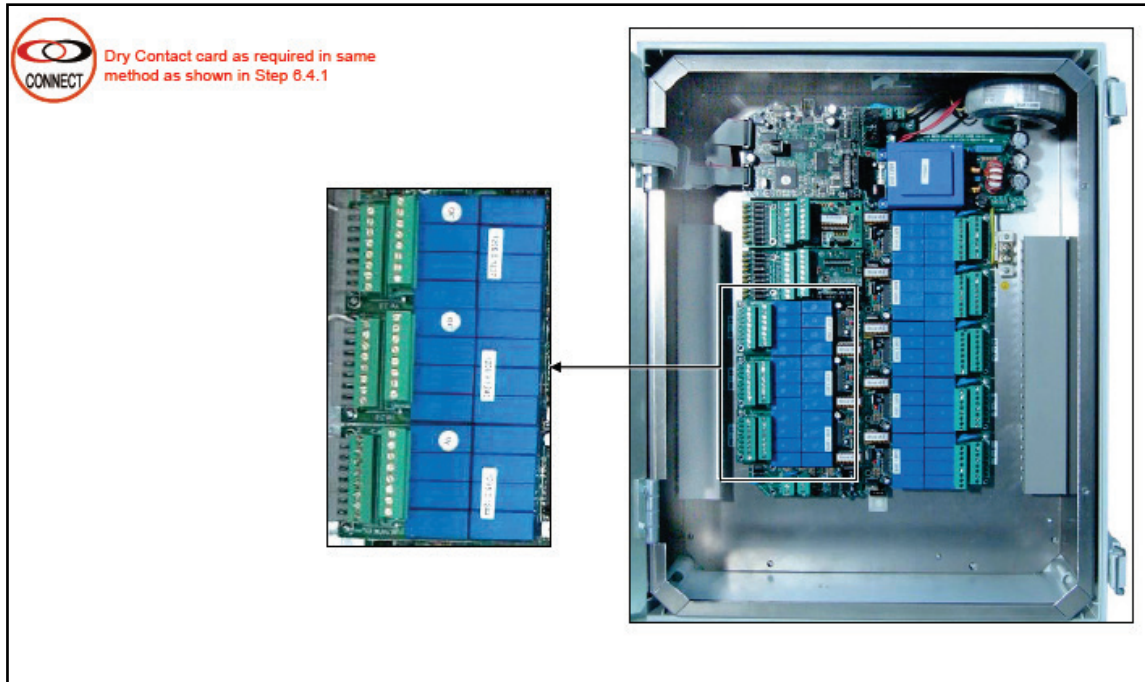

- Option 1 - Dry Contact Used as 24 VAC Output Card
- Option 2 - Dry Contact Used as Normally Open Contact

4.2.3.1 Option 1 - Dry Contact Used as 24 VAC Output Card

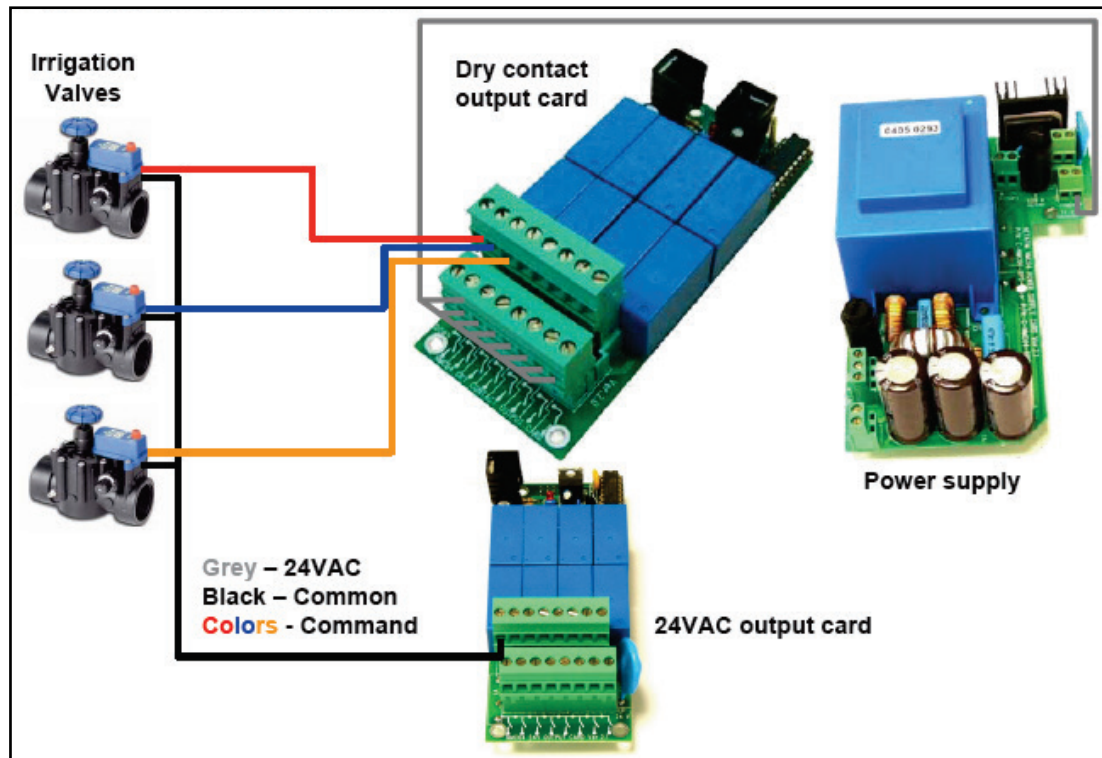

ELECTRICAL INSTALLATION

4.2.3.2 Option 2 - Dry Contact Used as Normally Open Contact

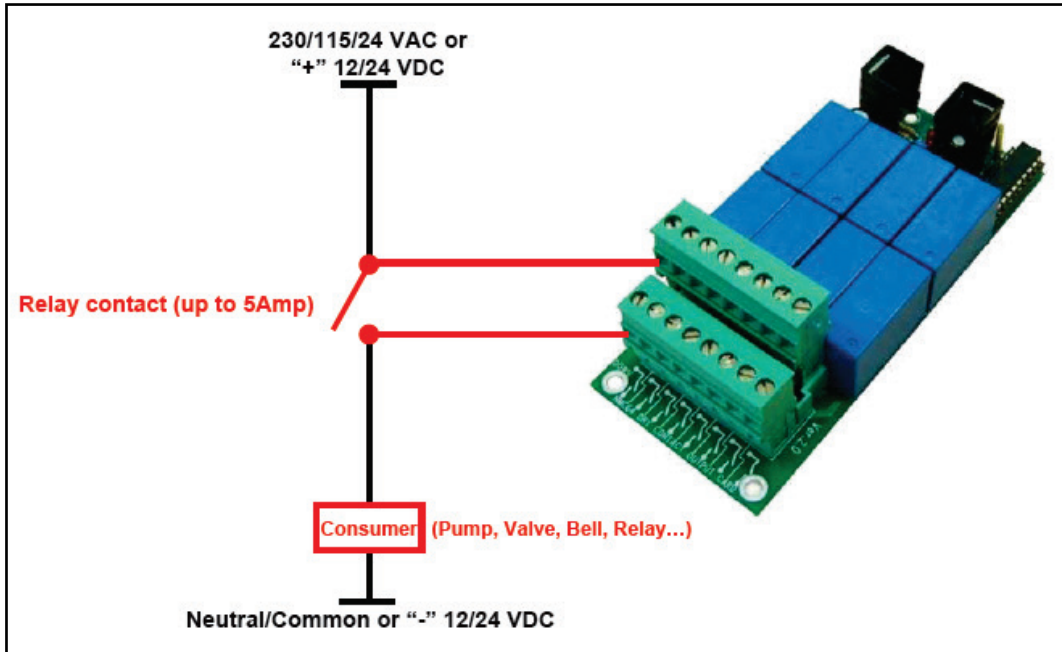

4.3 Input Terminals

- Wiring, page 25
- Analog Input Card, page 27

4.3.1 Wiring

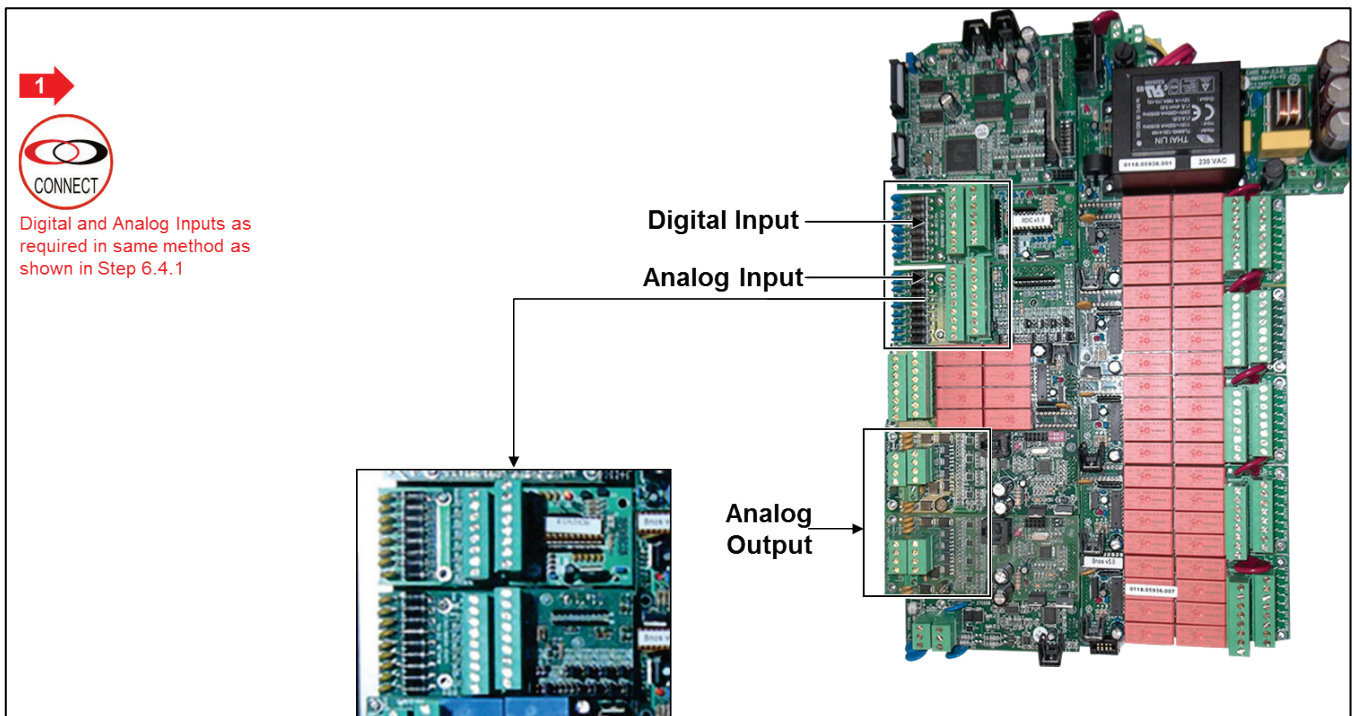

ELECTRICAL INSTALLATION

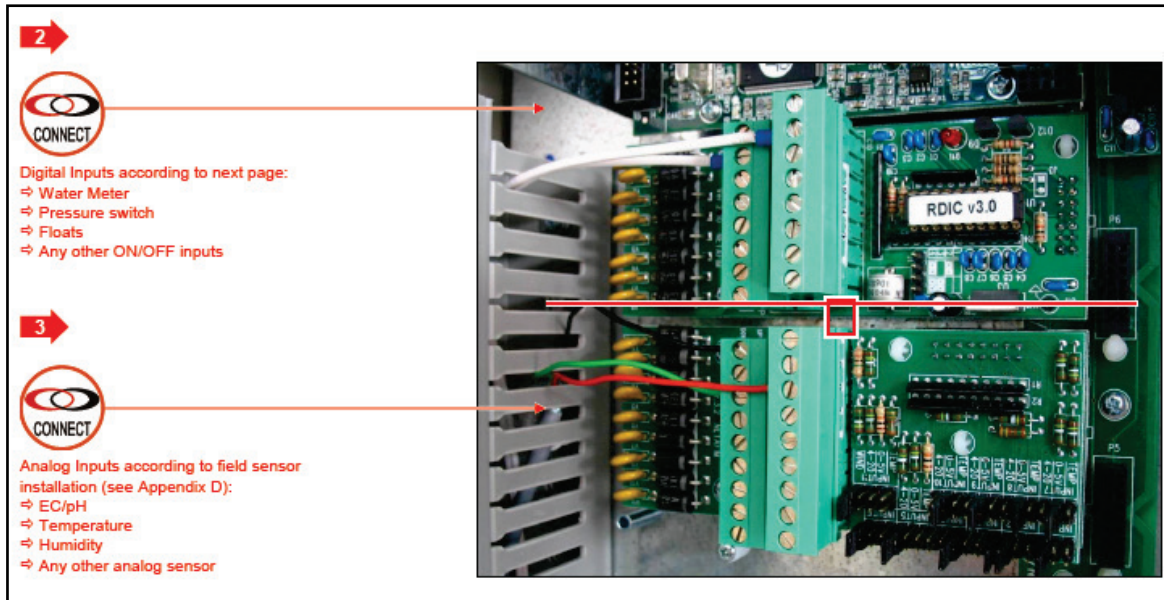

Digital Input Connection Examples

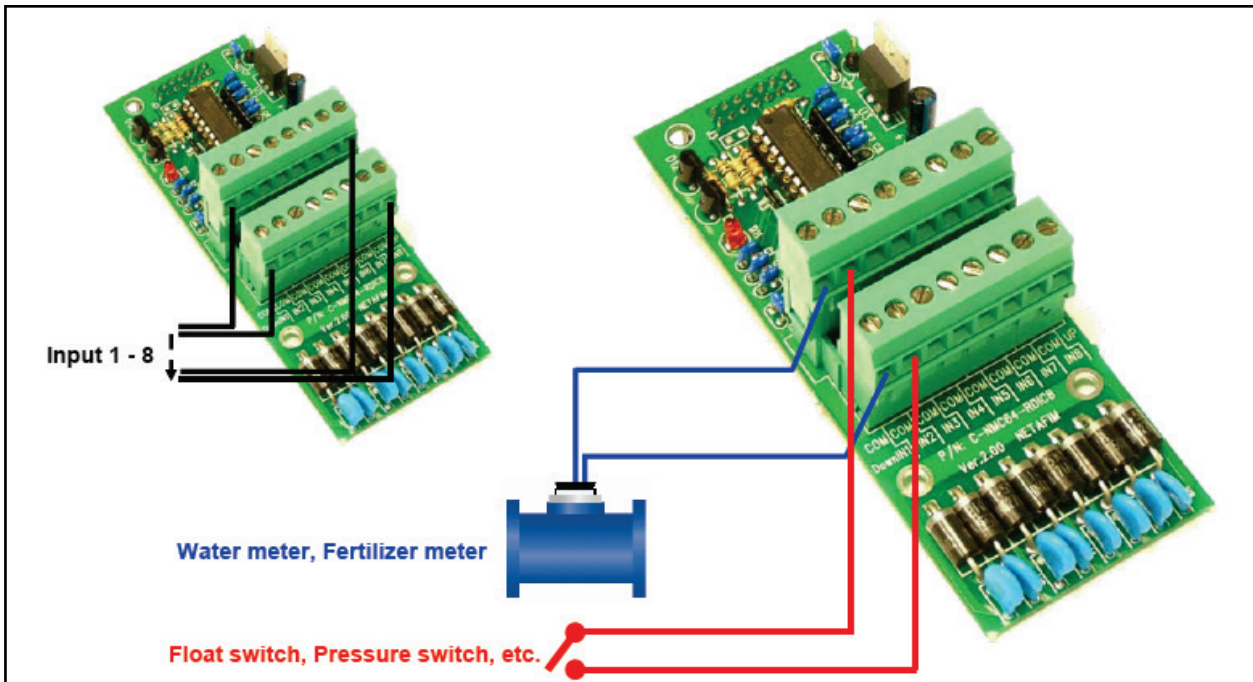

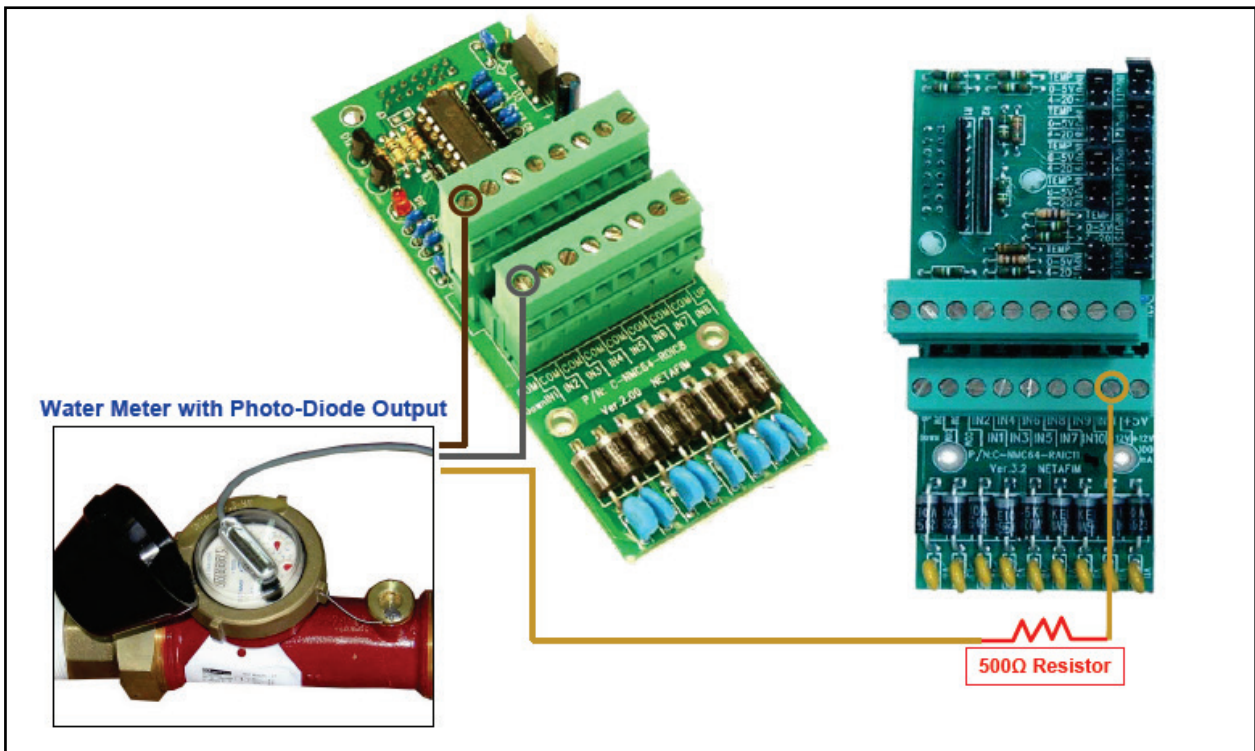

4.3.2 Analog Input Card

- The analog input card includes 11 x analog inputs.
- The type of every input can be selected by jumper positioning.

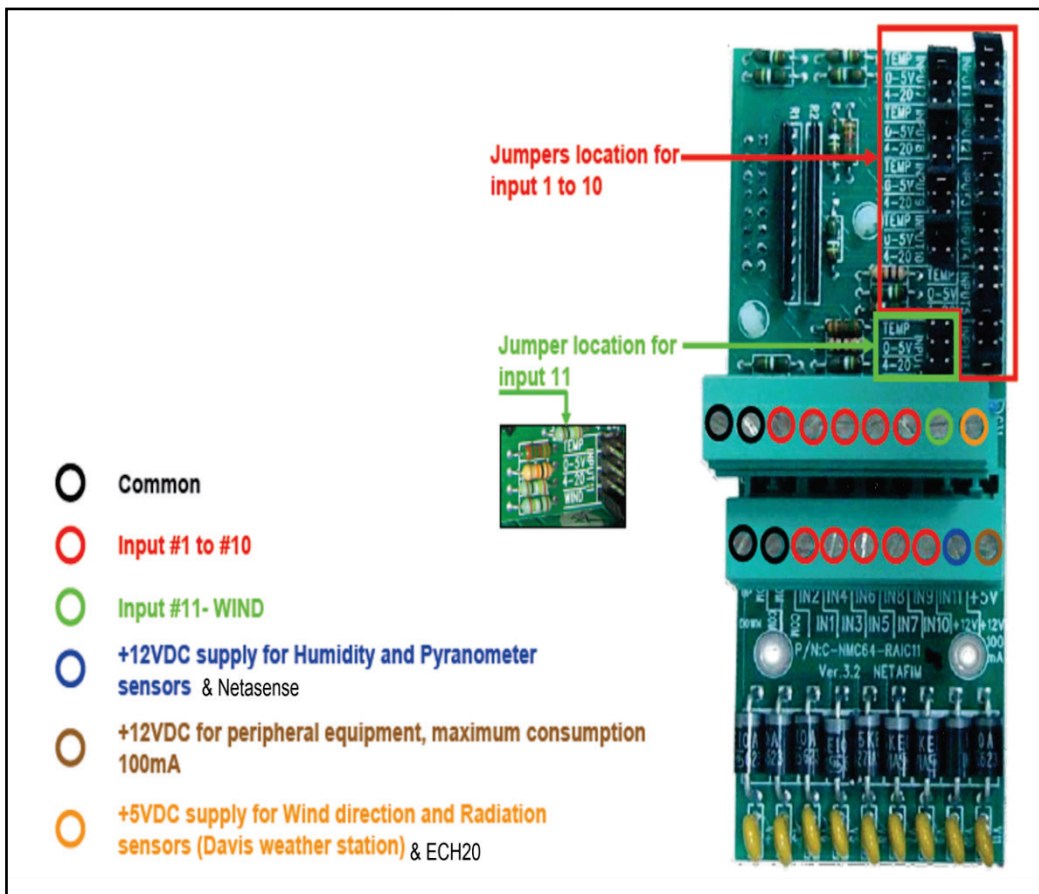

ELECTRICAL INSTALLATION

- NetSense, page 28
- Ech2o 5, page 29
- NetSense / Ech2o 5 Jumper Position, page 31

4.3.2.1 NetSense

- NetSense Specifications
- NetSense Installation

4.3.2.1.1 NetSense Specifications

- Stainless Steel with plastic coating
- All electronics are sealed in water-proof epoxy
- Temperature range:
 - ◆ Operating: 0° to 50° C
 - ◆ Storage: -20° to 60° C
- Output format: 0.5 - 5.0 mA
- Power requirements: 5.5 - 18 VDC, 10 - 20 mA (max)
- Accuracy: 1% Volumetric Soil Moisture

 **Note:** Less accuracy may be experienced in some cases

- Connection: 3 pin Switchcraft connector EN3C3M
- Dimensions (cm): 9.5 W x 3.2 D x 27.0 L
- Weight: 0.5 kg.
- Typical measurement field is 4 cm in all directions from the outside element

4.3.2.1.2 NetSense Installation

Connect as follows:

- **Yellow-Green** to COM
- **Brown** to +12V
- **Blue** to inputs 1 – 11; jumper 0 – 5V (In the example below, Blue is attached to Terminal 8.)

ELECTRICAL INSTALLATION

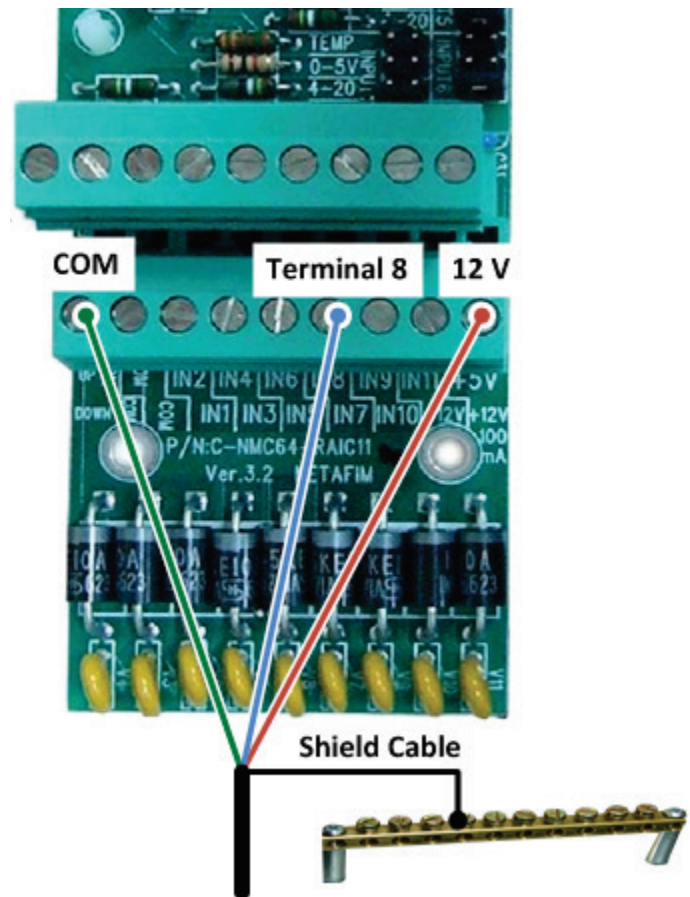
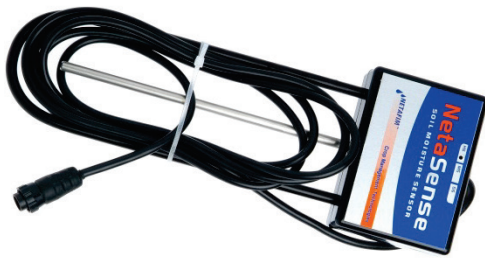

WARNING! TO ENSURE INTERFERENCE AND LIGHTNING IMMUNITY, USE SHIELDED CABLE ONLY (22 AWG MINIMUM)!
WARNING! POWER AND SIGNAL WIRES MUST BE IN SEPARATE CABLES!

4.3.2.2 Ech2o 5

- Ech2o 5 Specifications
- Ech2o 5 Installation
-

4.3.2.2.1 Ech2o 5 Specifications

- Measurement Time: 10 ms (milliseconds)
- Accuracy: at least 0.03 m³/m³ all soils, up to 8 dS/m with soil-specific calibration: ±0.02 m³/m³ (±2%)
- Resolution: 0.001 m³/m³ VWC in mineral soils, 0.25% in growing media
- Power Requirements: 2.5VDC - 3.6VDC @ 10mA
- Output: 10-40% of excitation voltage (250 - 1000mV at 2500 mV excitation)
- Operating Environment: -40° to +60° C
- Range of Measurement: 0 to saturation
- Sensor Dimensions (cm): 8.9 W x 1.8 D x 0.7 L

ELECTRICAL INSTALLATION

4.3.2.2.2 Ech2o 5 Installation

Connect as follows:

- **Red:** to inputs 1 – 11; jumper 0 – 5V (In the picture below, Red is attached to Terminal 9.)
- **Black** to +5V
- **Bare** to COM

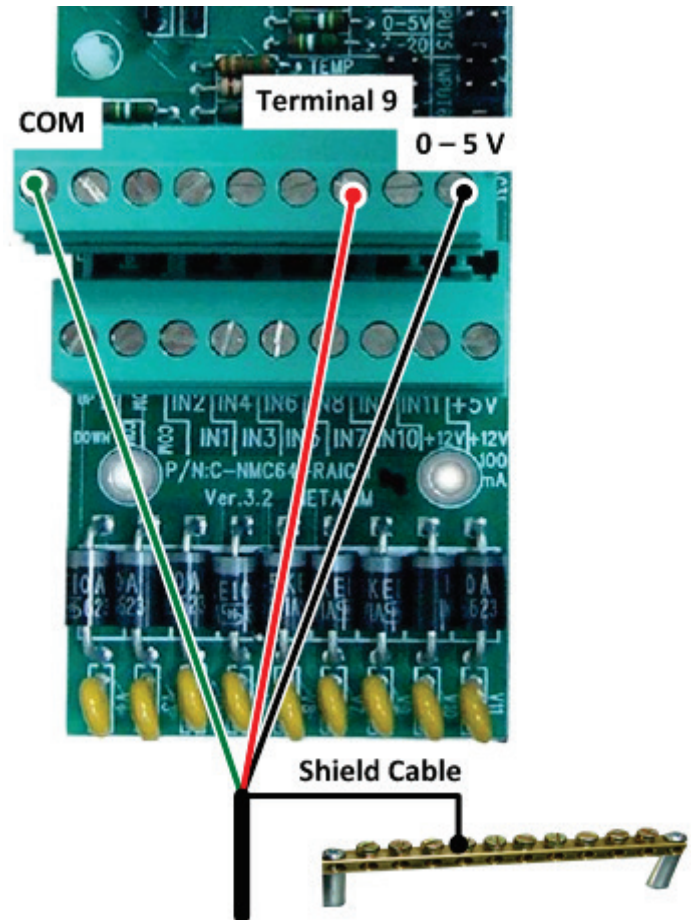

WARNING! TO ENSURE INTERFERENCE AND LIGHTNING IMMUNITY, USE SHIELDED CABLE ONLY (22 AWG MINIMUM)!

WARNING! POWER AND SIGNAL WIRES MUST BE IN SEPARATE CABLES!

ELECTRICAL INSTALLATION

4.3.2.3 NetSense / Ech2o 5 Jumper Position

When installing either the NetSense/ Ech2o 5, place the jumper on the 0 – 5 V terminals of the required channel position.

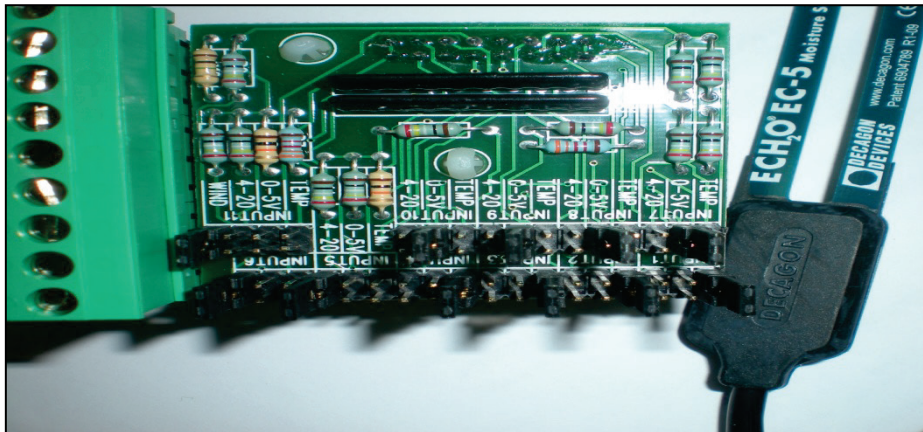

4.3.2.4 Analog Input Connection - Example: EC/pH Sensors

Note: See Appendix D.

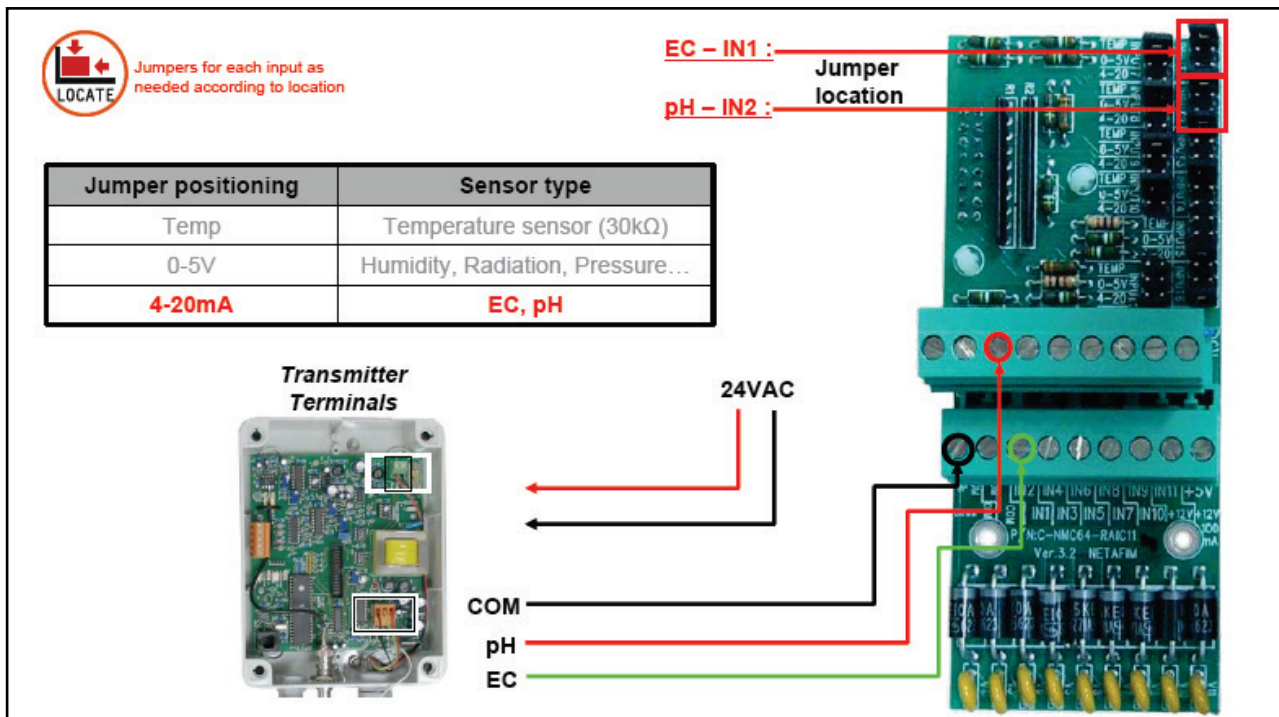

4.4 Expansion Unit Connection: Card Connection Options

- Option A: RS-485 Connection, page 32
- Option B: RS-232 Direct Connection, page 34
- Option C: RS-232 via Line Driver Connection, page 35
- Wrong Relay Connection, page 36
- Expansion Unit, page 36
- PC and Inter-Controller Communication, page 37

ELECTRICAL INSTALLATION

4.4.1 Option A: RS-485 Connection

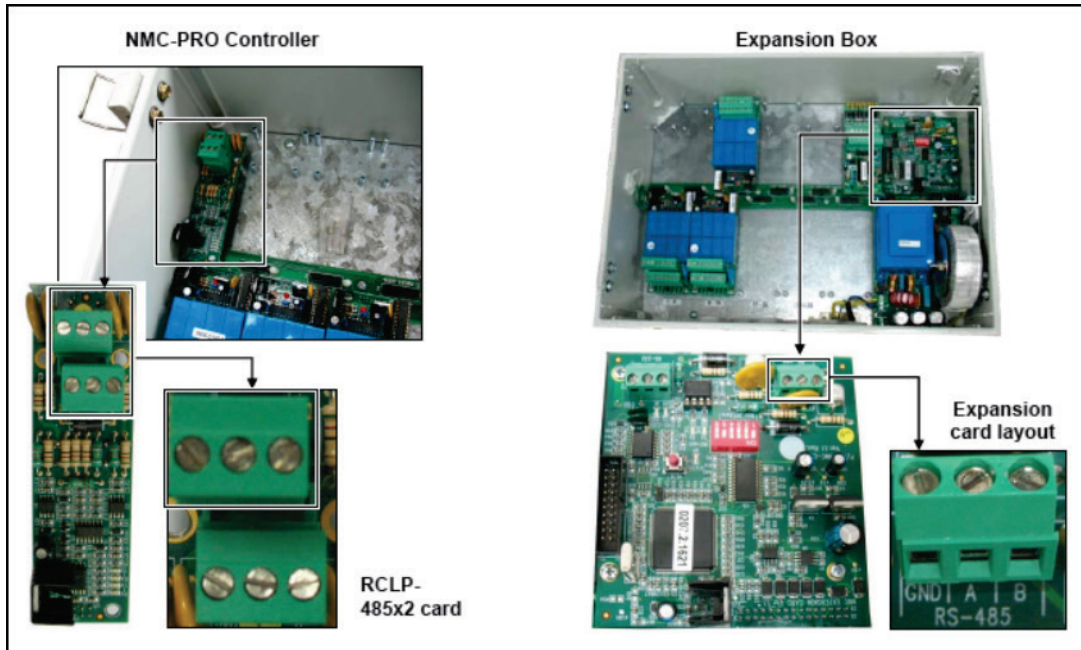

Note: If there are more than 64 outputs, use an extension box.

Note: Distance from controller: See table on next page.

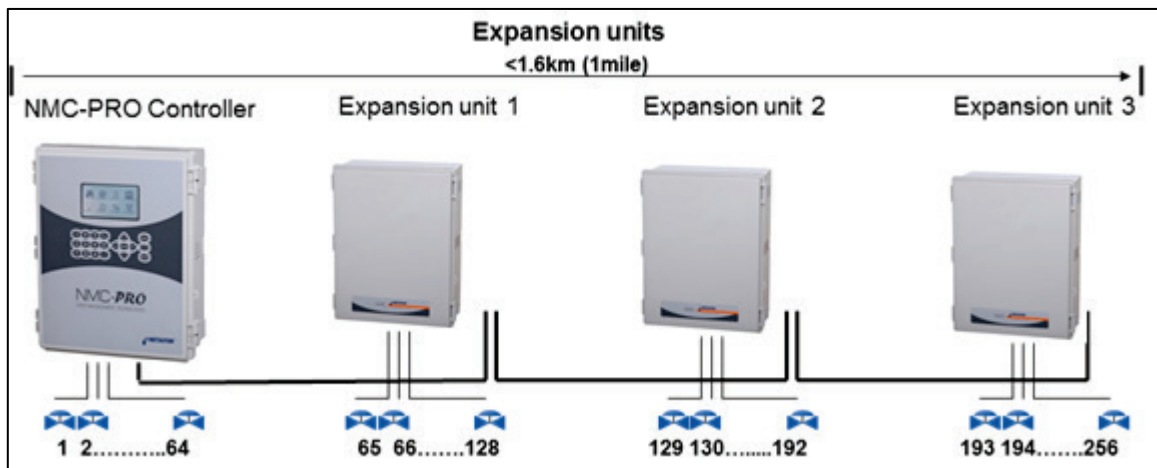

Note: The maximum number of outputs is 256 but the maximum number of valves is 255.

ELECTRICAL INSTALLATION

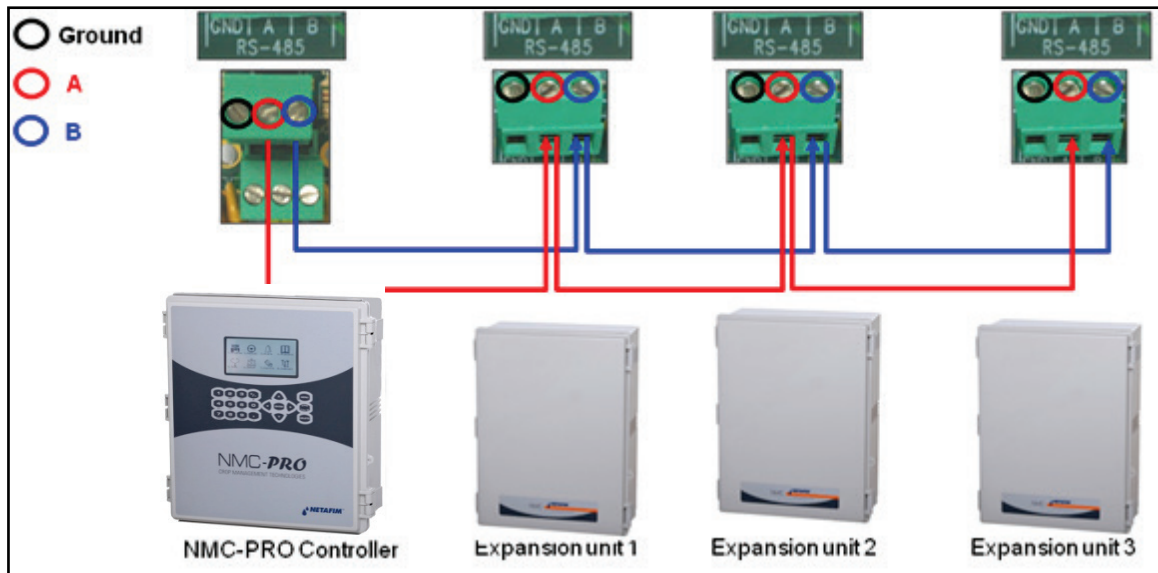

Note: See the following table for details on permitted distances from the controller.

Table 1: Permitted Distance from Controller RS-485

One Expansion Box	Distance	Baud Rate
	2000 m	9600
	2500 m	4800
	3000 m	2400
Three Expansion Boxes	Distance	Baud Rate
	1200 m	9600
	1800 m	4800
	3000 m	2400

ELECTRICAL INSTALLATION

4.4.2 Option B: RS-232 Direct Connection

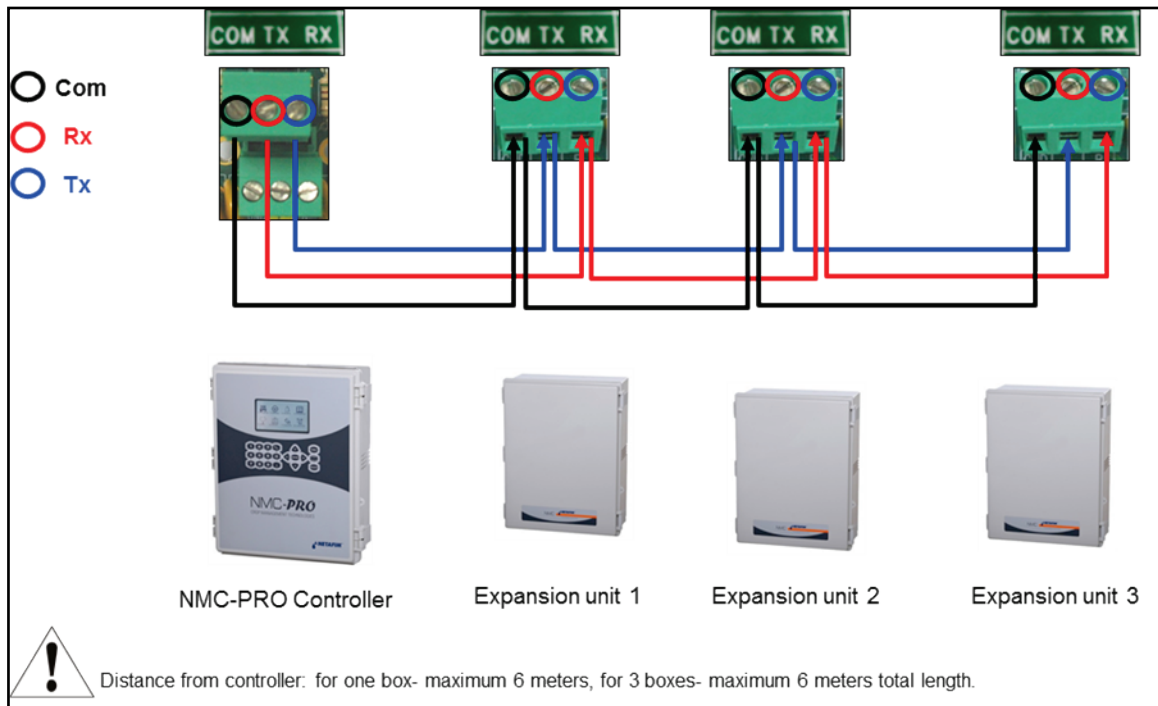
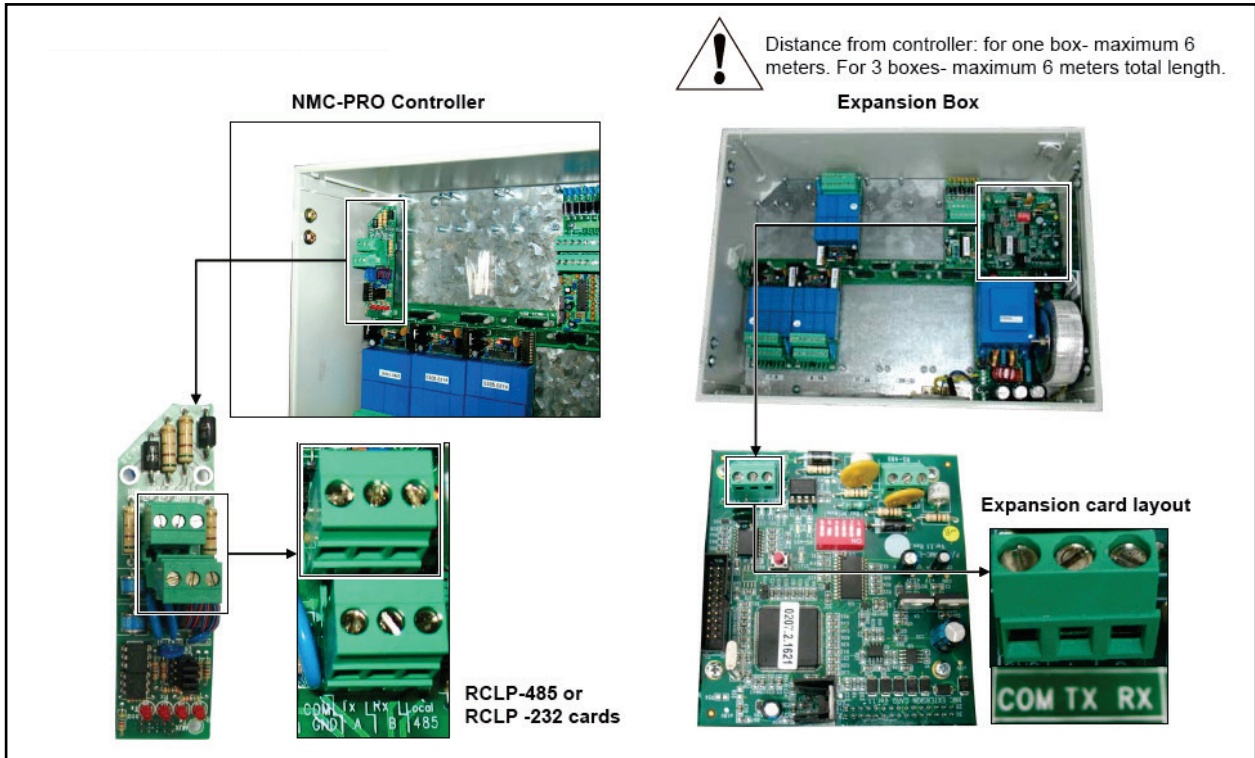

ELECTRICAL INSTALLATION

4.4.3 Option C: RS-232 via Line Driver Connection

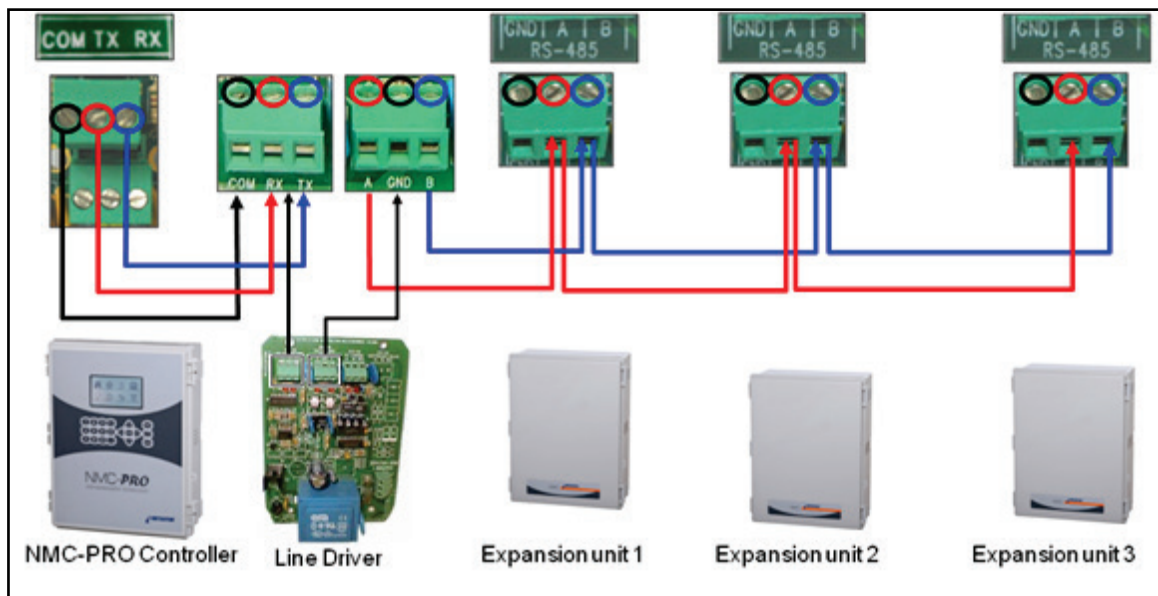
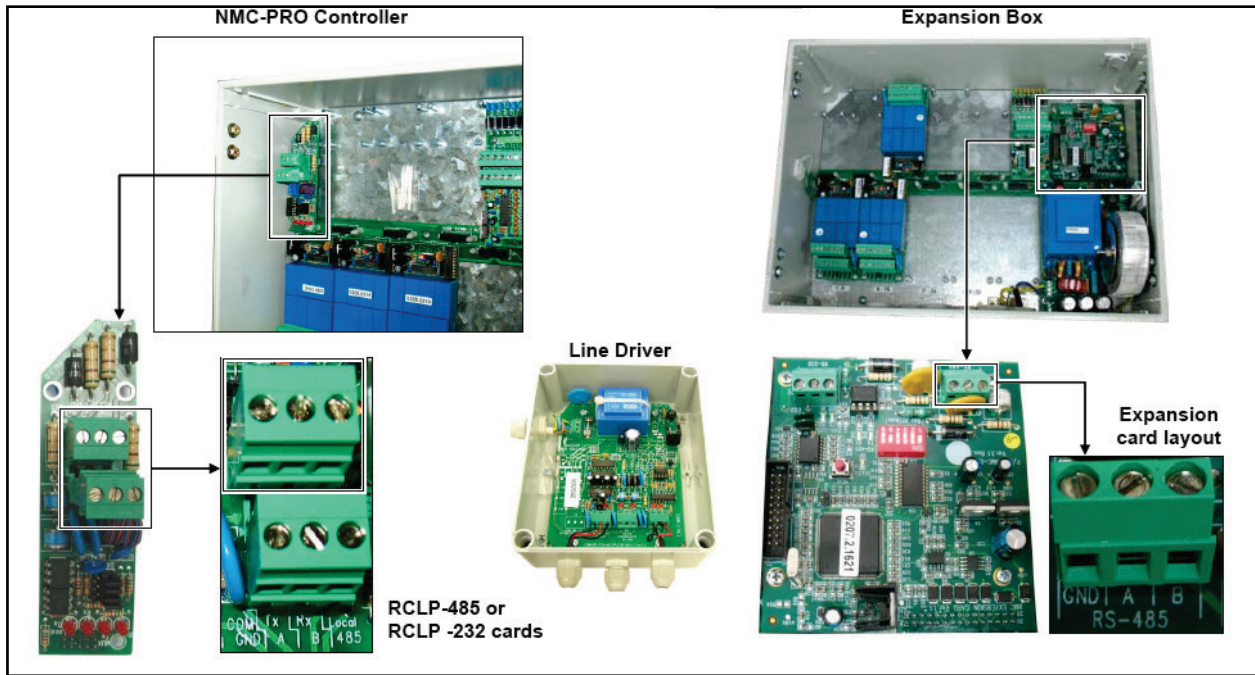

Refer to Table 1, page 33 regarding permitted distances.

ELECTRICAL INSTALLATION

4.4.4 Wrong Relay Connection

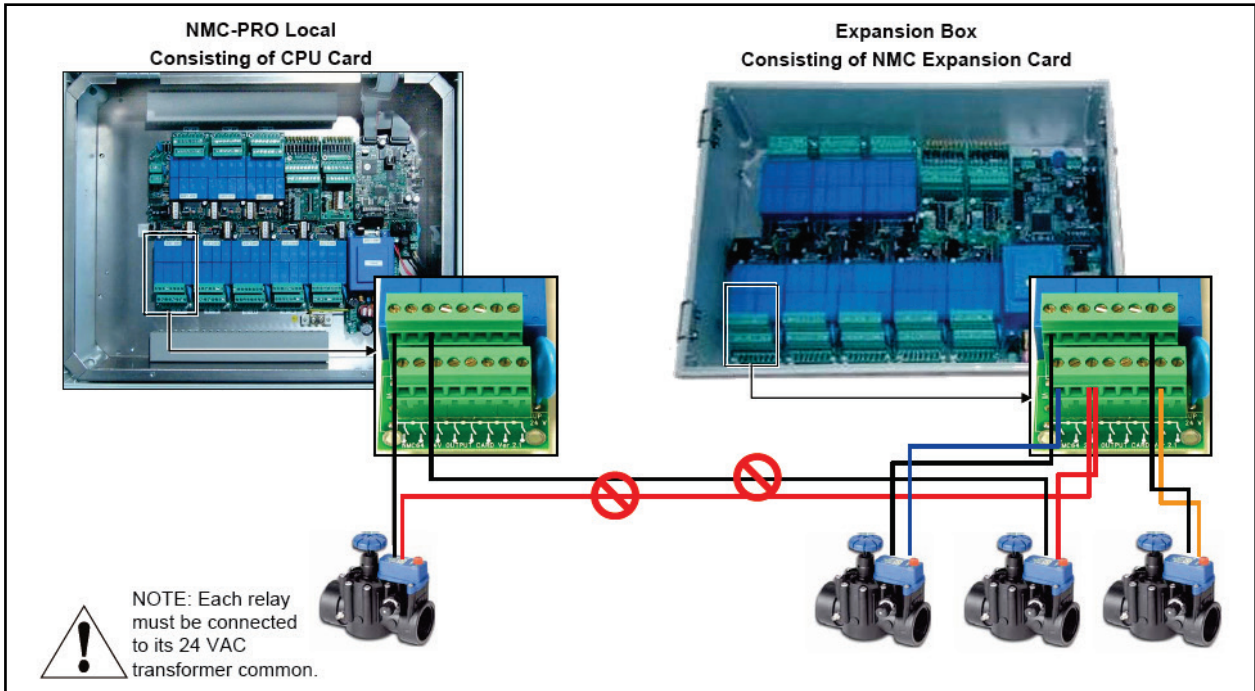

4.4.5 Expansion Unit

- Expansion Unit Settings, page 36
- System Setup, page 37

Expansion Comm Switches		
4	5	Baud rate
OFF	OFF	2400
ON	OFF	4800
OFF	ON	9600
ON	ON	19200

4.4.5.1 Expansion Unit Settings

6 does nothing

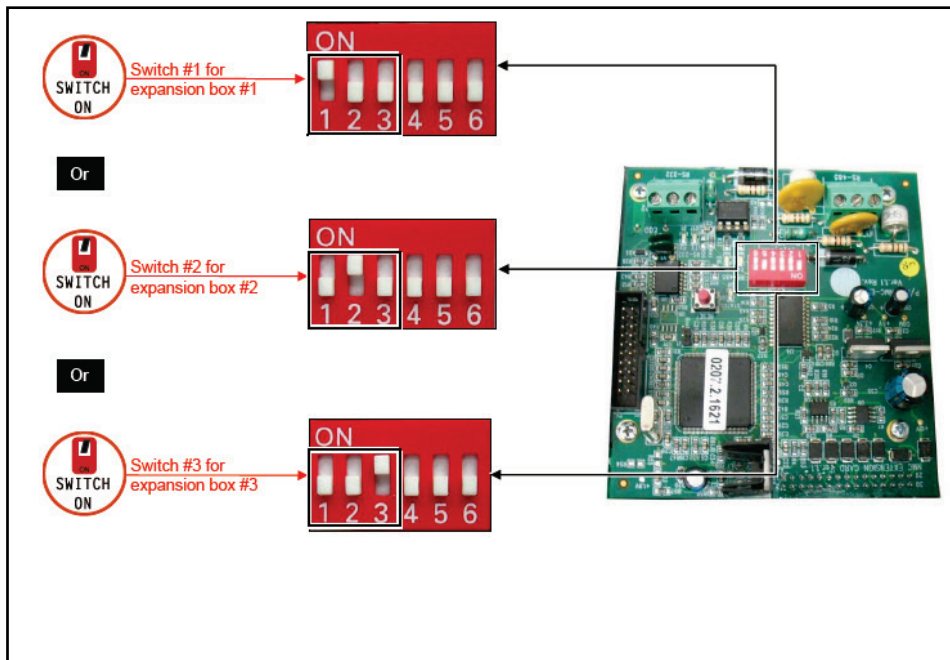

ELECTRICAL INSTALLATION

4.4.5.2 System Setup

SWITCH ON
Main power



1

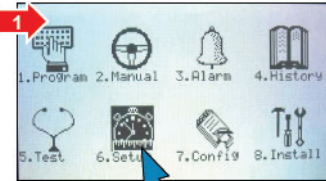

2

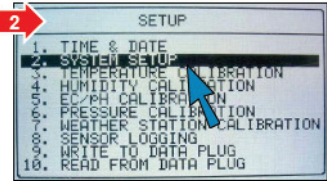

SELECT
⇒ "6. Setup"
⇒ "2. System setup"

3

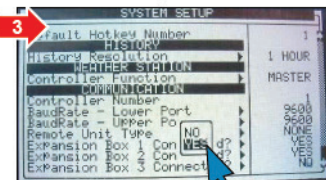

4

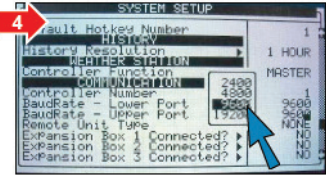

PERFORM
Set connected expansion boxes to "YES"

4

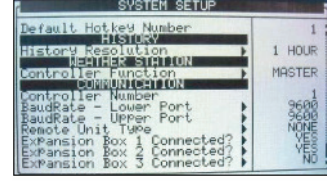

SELECT
Baud rate according to cable length and number of controllers

4.4.6 PC and Inter-Controller Communication

- Test Relays, page 43
- Digital Input Test, page 44
- Analog Input Test, page 44

4.4.6.1 Card Installation

Insert RS-485/485x2 card
Option A: RS-485

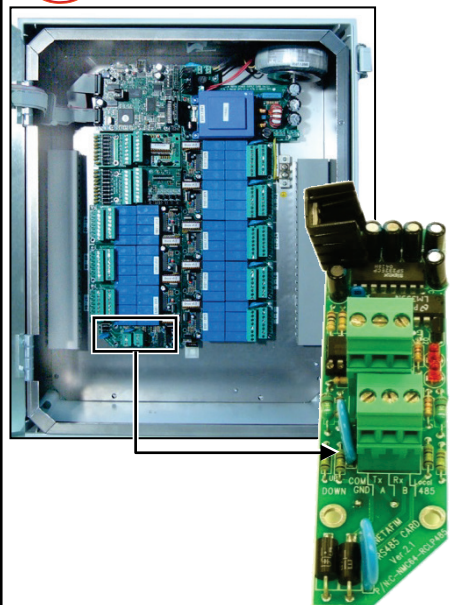

Insert RS-232 card
Option B: RS-232

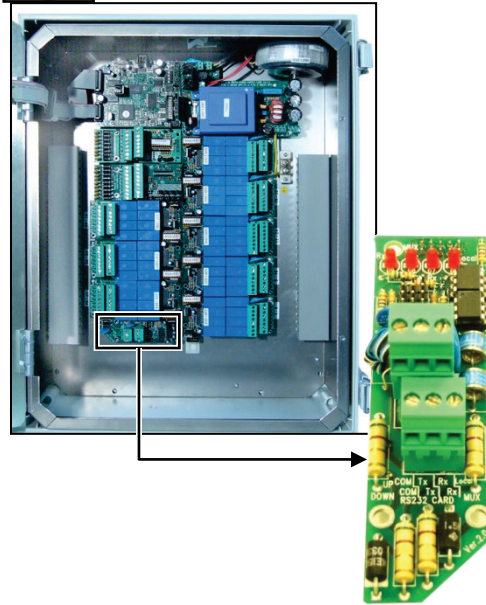

ELECTRICAL INSTALLATION



Insert Onboard SMS card

Option C: GSM

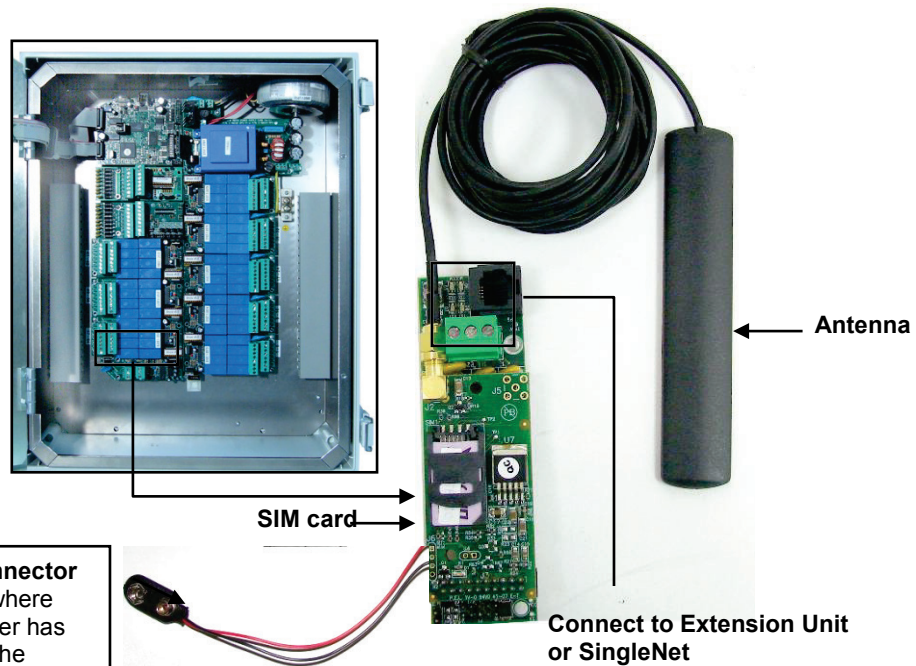

Backup Battery Connector
If a situation occurs where the controller no longer has power (power is off) the backup battery that is connected to this card through this connector, allows for a single SMS to be sent for notification of this alarm.

4.4.6.2 Wiring and Controller Setup

- Option A: RS-485
- Option B: RS-232

4.4.6.2.1 Option A: RS-485

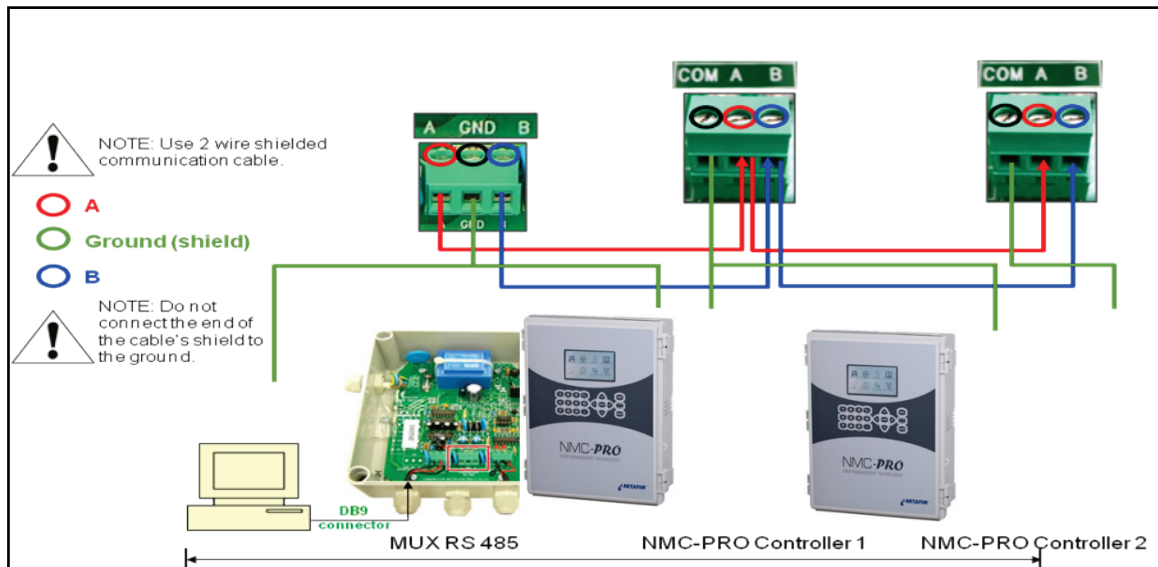

ELECTRICAL INSTALLATION

4.4.6.2.2 Option B: RS-232

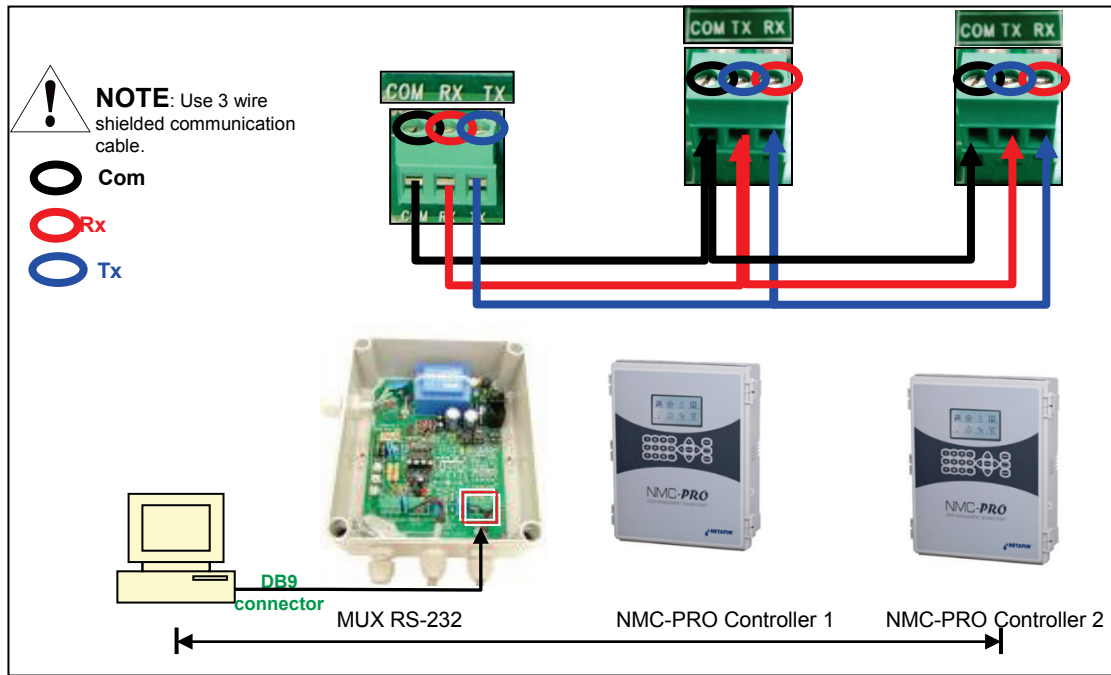

COMMUNICATION DISTANCE AND BAUD RATE

Baud Rate	One Controller	10 Controllers
9600 BPS	2000 meter 1.25 mile	1200 meter 0.75 mile
4800 BPS	2500 meter 1.55 mile	1800 meter 1.12 mile
2400 BPS	3000 meter 1.86 mile	2400 meter 1.49 mile

△ Baud rate is dependent on cable length and number of controllers.

ELECTRICAL INSTALLATION

4.5 Controller Setup

- Start-Up, page 40
- Hardware Checklist, page 40
- Output Definition, page 41
- Digital Input Definition, page 41
- Analog Input Definition, page 42

4.5.1 Start-Up

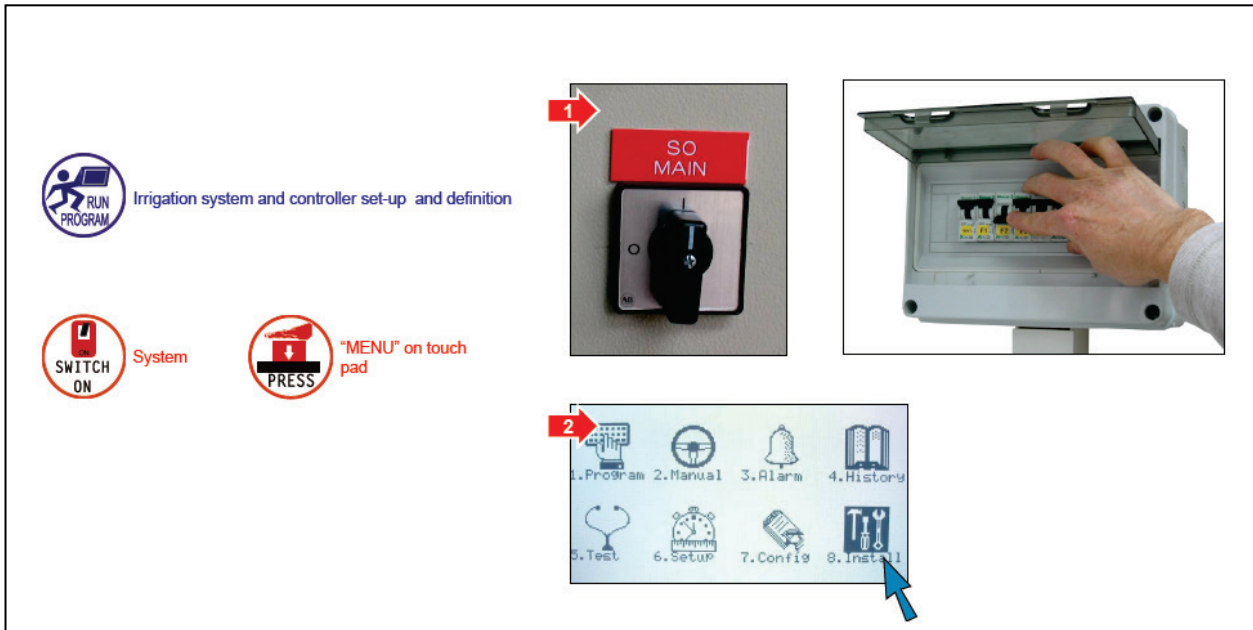

4.5.2 Hardware Checklist

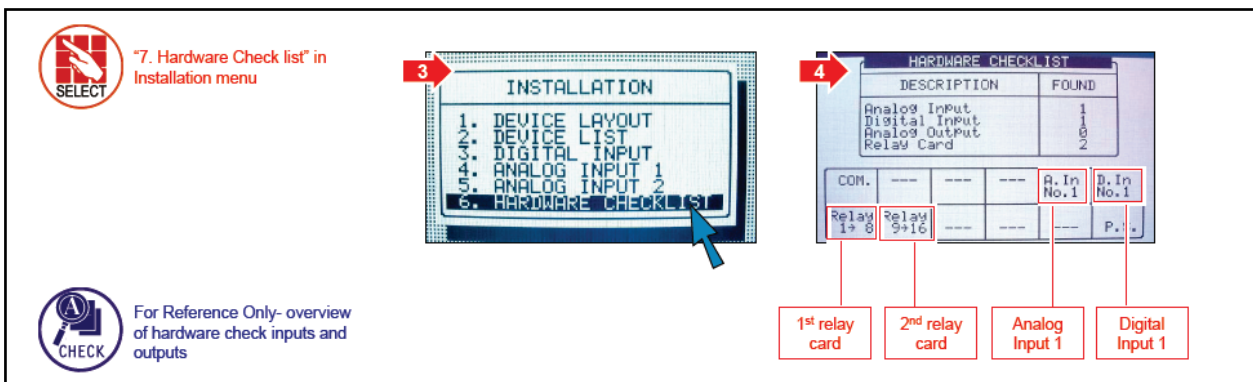

Note: System in the example shown above is equipped with:
16 outputs
8 digital inputs
11 analog inputs
*Additional cards available upon special request.

4.5.5 Analog Input Definition



"5. Analog Input 1" in Installation menu



Channel 1 and enter additional sensors according to terminal



Previous step for all other analog input sensors

1



2

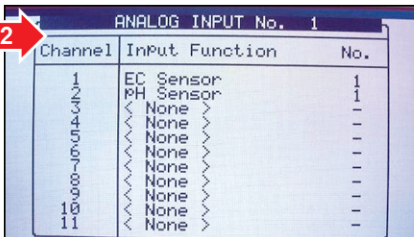

Note: For sensor installation and definition, please refer to Appendix D.

4.5.6 Analog Output Definition

1. In the Installation menu, select Device Layout.

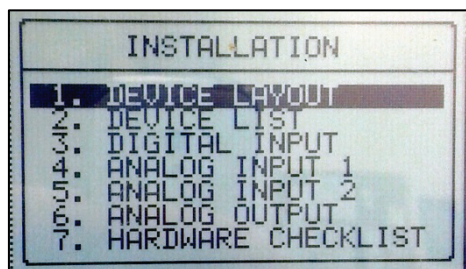

2. In the screen that appears, define the required number of channels as Dosing channels.

Relay	Funci	06. Dosing Channel
LOCAL 1	Dosing	07. Dosing Booster
LOCAL 2	Dosing	08. Selector
LOCAL 3	Dosing	09. Agitator
LOCAL 4	Dosing	10. Cooling
LOCAL 5	Dosing	11. Misting
LOCAL 6	Dosing	12. Water Heater
LOCAL 7	Dosing	13. Alarm
LOCAL 8	Dosing	14. Cond. Active #
LOCAL 9	Dosing	15. EC P-Ctrl Open
LOCAL 10	None	16. EC P-Ctrl Clos
LOCAL 11	None	17. EC P-Ctrl Pump

Note: The possible number of Dosing Channel depends on the number of installed analog output cards.

3. In the Installation menu, select Analog Output.



4. In the screen that appears, map analog outputs to dosing channels

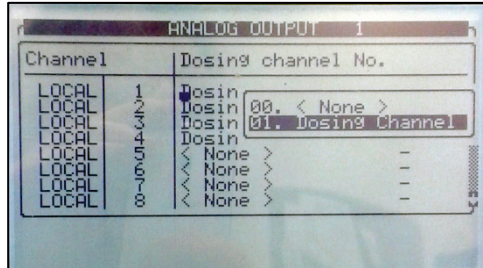

4.6 Controller Test Procedure

- Test Relays, page 43
- Digital Input Test, page 44
- Analog Input Test, page 44

4.6.1 Test Relays



"5. Test" in Main Menu



⇒ "1. Relays" to test output devices in the field (dry test)
 ⇒ Highlight status, press ENTER, "MAN" appears
 ⇒ To end process press ENTER again



For Irrigation valve test, send someone out in field with Walky-Talky to verify status

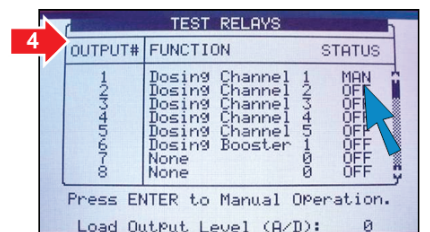
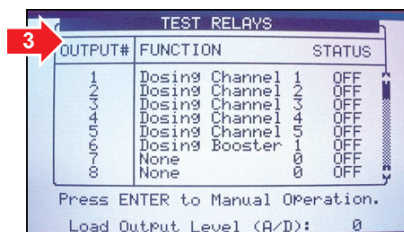
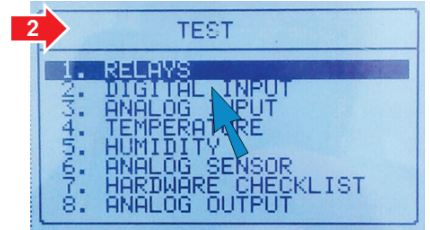
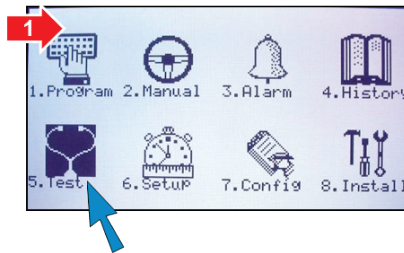

Output Level (A/D): ≤300 A/D when all outputs are on.
 If output level is above 300, see Troubleshooting Appendix B

ELECTRICAL INSTALLATION

4.6.2 Digital Input Test



"2. Digital Input" in Test menu

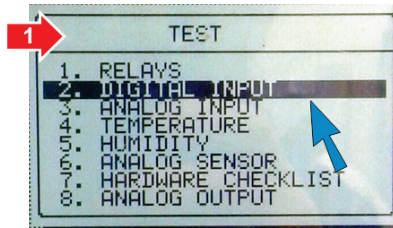

2

Channel	Card No.1	Card No.2
1	25	0
2	1	0
3	0	0
4	0	0
5	0	0
6	0	0
7	0	0
8	0	0



Dry test- Get a pulse using magnet; attach magnet to get a pulse from the "read" of the cable



⇒ Water, fertilizer and any auxiliary meters: Count up 1-256
⇒ Delta pressure and other dry contact inputs: 1= ON, 0= OFF

3



4.6.3 Analog Input Test



"3. Analog Input" in Test menu
See table on the next page

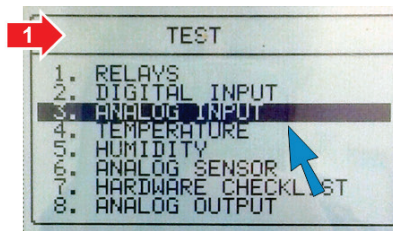

2

Channel	Card No.1	Card No.2
1	207	---
2	479	---
3	1022	---
4	1022	---
5	1022	---
6	1022	---
7	1023	---
8	1	---
9	1	---
10	1	---
11	1009	---



"4. Temperature" or "5. Humidity"-
values will be displayed

3

No.	Value
1	23.8
2	---
3	---
4	---
5	---
6	---
7	---
8	---

4

No.	Value
1	58.1
2	---
3	---
4	---
5	---
6	---
7	---
8	---

Channel	Card No.1	Card No.2
1	479	791
2	646	646
3	979	979
4	1022	1022
5	1065	1065
6	1010	1010
7	1011	1011
8	1013	1013
9	318	318
10	348	348
11	1001	706

DESCRIPTION	SENSOR TYPE
pH = 0 – A/D = 205	pH sensor
pH = 7.0 – A/D = 615	
pH = 14.0 – A/D = 1023	

DESCRIPTION	SENSOR TYPE
EC = 0 – A/D = 205	EC sensor
EC = 2.0 – A/D = 370	
EC = 10.0 – A/D = 1024	
RH% = 0 – A/D = 0	Humidity sensor
RH% = 50 – A/D = 308	
RH% = 100 – A/D = 620	
T°C = 0 – A/D = 768	Temp sensor
T°C = 25 – A/D = 489	
T°C = 50 – A/D = 250	

4.6.4 Analog Output Test

The Analog Output Test screen performs two functions:

- Automatic test: Displays the current state of the valves (functioning or not functioning)
- Manual test: Tests their response to a test signal

△ If there is a non-functioning (analog-output controlled) valve, a message appears on the main screen.

4.6.4.1 Automatic Test

Automatic testing shows the current state of the valves.

1. Go to Test > Analog Output.

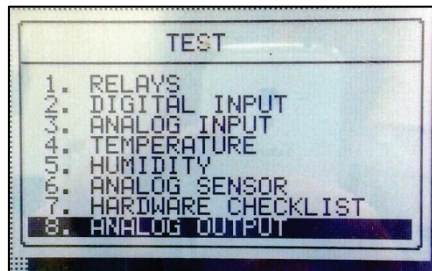

2. The screen displays the following:

N#	Status	Open%	Meas	Fail
1	AUTO	----	54.5	ON
2	AUTO	----	4.4	ON
3	AUTO	----	4.4	ON
4	AUTO	----	4.4	ON
5	AUTO	----	0.0	OFF
6	AUTO	----	0.0	OFF
7	AUTO	----	0.0	OFF
8	AUTO	----	0.0	OFF

- When the test is set to Auto, the screen displays the status of active dosing valves.
 - ◆ Active valves display a voltage under Meas.
 - ◆ If the status (under Fail) is ON, the valve is closed.
 - ◆ In the screen above, valves 1 – 4 are active, but they are closed.

ELECTRICAL INSTALLATION

4.6.4.2 Manual Test

Manual testing enable you to verify that valves open in response to an electrical current.

1. Go to Test > Analog Output.

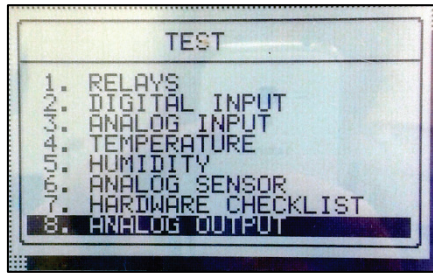

2. The screen displays the following:

N#	Status	Open%	Meas	Fail
1	AUTO	----	54.56	ON
2	AUTO	----	54.56	ON
3	AUTO	----	54.56	ON
4	AUTO	----	54.56	ON
5	AUTO	----	54.56	ON
6	AUTO	----		OFF
7	AUTO	----		OFF
8	AUTO	----		OFF
9	AUTO	----		OFF

3. Place the cursor on the valve requiring testing, press **Enter** and select.

N#	Status	Open%	Meas	Fail
1	MAN	----	54.56	ON
2	AUTO	----	54.56	ON
3	AUTO	----	54.56	ON
4	AUTO	----	54.56	ON
5	AUTO	----	54.56	ON
6	AUTO	----		OFF
7	AUTO	----		OFF
8	AUTO	----		OFF
9	AUTO	----		OFF

4. Under Open%, enter an opening percentage.

N#	Status	Open%	Meas	Fail
1	MAN	33-	54.56	ON
2	AUTO	----	54.56	ON
3	AUTO	----	54.56	ON
4	AUTO	----	54.56	ON
5	AUTO	----	54.56	ON
6	AUTO	----		OFF
7	AUTO	----		OFF
8	AUTO	----		OFF
9	AUTO	----		OFF

- ◆ Pro sends an electrical current to the valve, based on the number entered.
- ◆ If the valve opens, **OFF** appears under Fail. If the valve does not open, **ON** appears.

4.7 System Configuration Procedure

- Device Delay Configuration, page 47
- Pump Station Configuration, page 48
- Valve Configuration, page 48
- Valve Flow Rate Configuration, page 48
- Water Meter Configuration, page 49
- Dosing Configuration, page 50
- EC/PH Sensor Range, page 51

ELECTRICAL INSTALLATION

- History Resolution, page 51
- System Nutrigation™ Check, page 52
- Data Plug, page 54

4.7.1 Device Delay Configuration

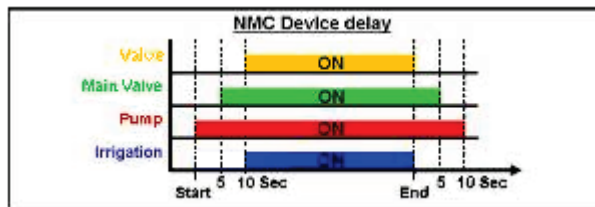
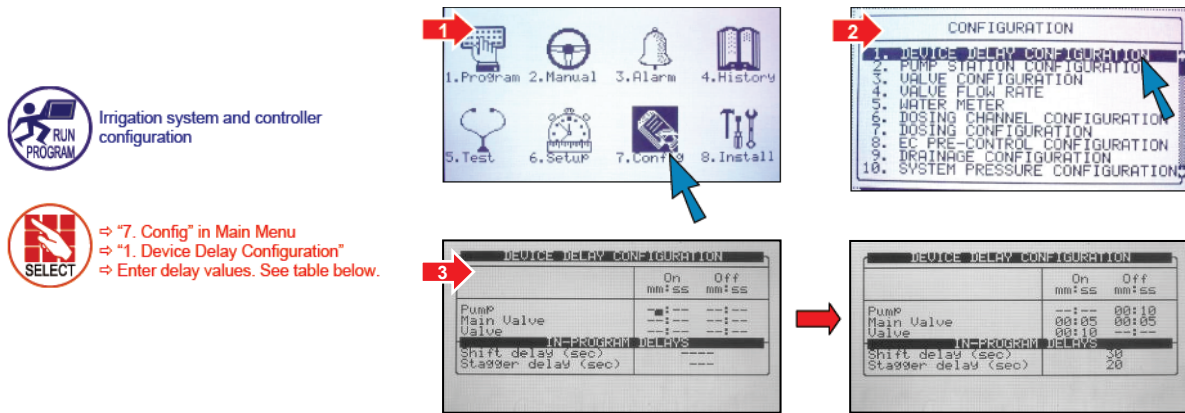

Note: Settings in the graph are for example only.

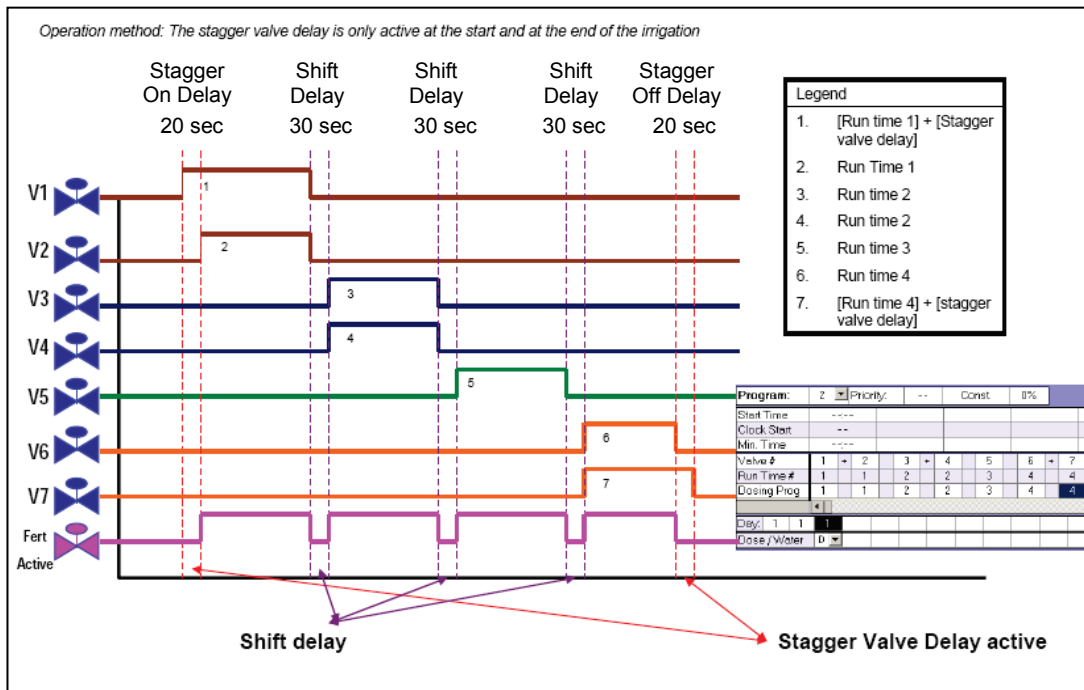

Note: During shift and stagger delays, the Fertilization is not active

ELECTRICAL INSTALLATION

4.7.2 Pump Station Configuration

 ⇒ "2. Pump Station Configuration"
⇒ Define capacity of main pump (USA: Gallon/min.)

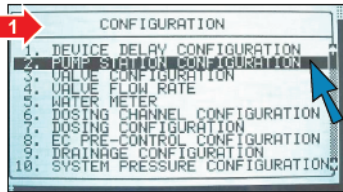
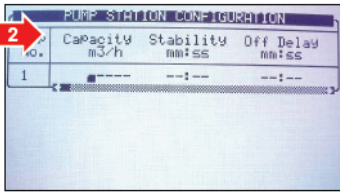
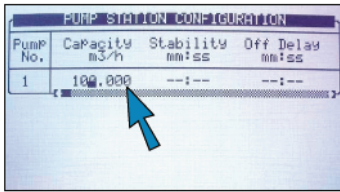
Note: If there is more than one pump, refer to NMC-Pro Advanced Settings.

4.7.3 Valve Configuration

 ⇒ "3. Valve Configuration"
⇒ Allocate pump, main valve and water meter
(Note: If there is more than 1 pump, refer to NMC-Pro User Manual)



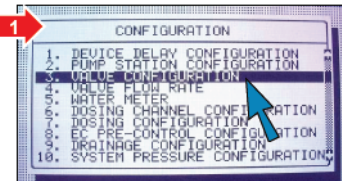
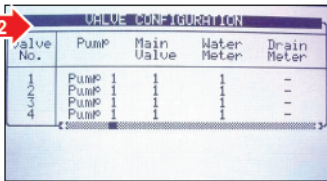

4.7.4 Valve Flow Rate Configuration

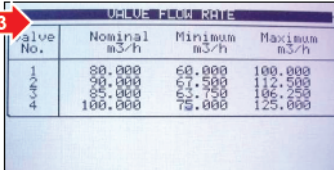
 ⇒ "4. Valve Flow Rate" (USA: Gallon/min.)
⇒ Define exact flow consumption of every valve:
Technician must calculate formula:
[Drippers/lateral x dripper capacity (liters/hr) x # of laterals/valve] ÷ 1000 = nominal flow of valve (m³/hr)
⇒ Set Min./Max. flow rate limits per valve for alarm (already defined as 25% by default)

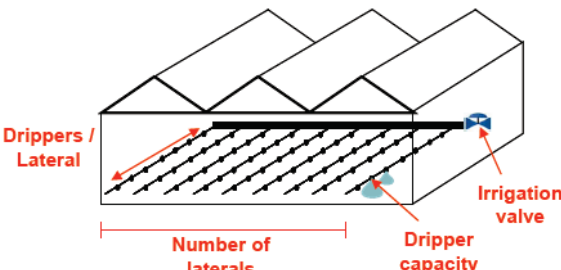
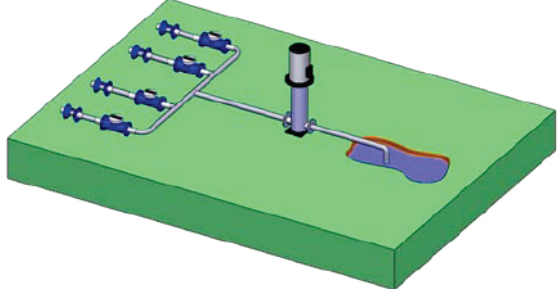

 **NOTE:** In case of use of multiple water meters or drain meter, please refer to *Advanced Settings*

ELECTRICAL INSTALLATION

4.7.5 Water Meter Configuration

SELECT

- ⇒ "5. Water Meter"
- ⇒ Define resolution of water meter- See label on water meter as shown in Step 2 (USA: Gallon/min.)

CHECK

If there is no label, check data sheet supplied with the meter.

1

2

3

Description	Ratio	Type
Water Meter 1(L/P)	10.000	STANDARD
Water Meter 2(L/P)	---	STANDARD
Water Meter 3(L/P)	---	STANDARD
Water Meter 4(L/P)	---	STANDARD
Water Meter 5(L/P)	---	STANDARD
Water Meter 6(L/P)	---	STANDARD
AUX Meter 1(L/P)	---	---
AUX Meter 2(L/P)	---	---
AUX Meter 3(L/P)	---	---
AUX Meter 4(L/P)	---	---

Note: If there is more than one water meter, refer to NMC-Pro Advanced Settings.

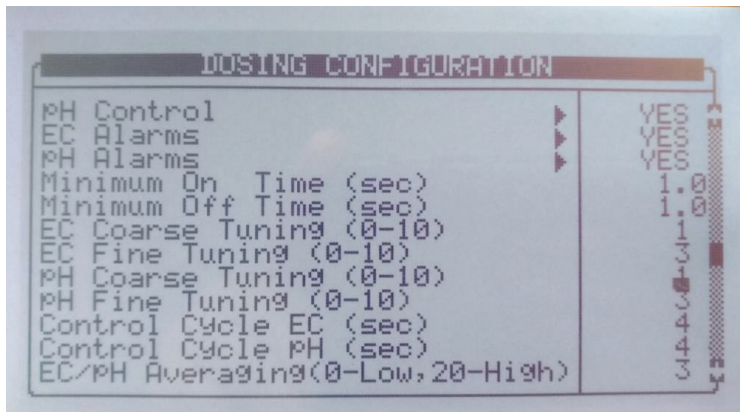

4.7.6 Dosing Channel Configuration

SELECT

- ⇒ "6. Dosing channel Configuration"
- ⇒ Define flow rate of every Venturi (USA: Gallon/hr.)
- ⇒ Define channels 1-4=EC
- ⇒ Define channel 5=Acid

1

2

3

→

ELECTRICAL INSTALLATION

4.7.7 Analog Dosing Channel Configuration

1. Go to Configuration > Dosing Channel Configuration.

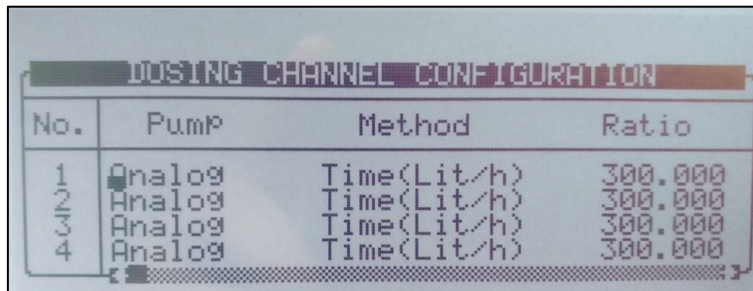

No.	Pump	Method	Ratio
1	Analog	Time(Lit/h)	300.000
2	Analog	Time(Lit/h)	300.000
3	Analog	Time(Lit/h)	300.000
4	Analog	Time(Lit/h)	300.000

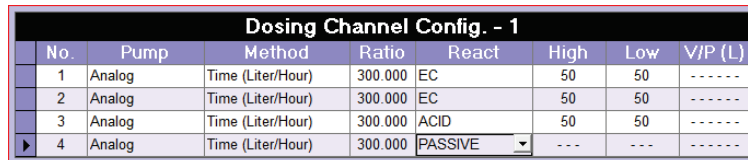

No.	Pump	Method	Ratio	React	High	Low	V/P (L)
1	Analog	Time (Liter/Hour)	300.000	EC	50	50	-----
2	Analog	Time (Liter/Hour)	300.000	EC	50	50	-----
3	Analog	Time (Liter/Hour)	300.000	ACID	50	50	-----
4	Analog	Time (Liter/Hour)	300.000	PASSIVE	---	---	-----

2. Define the Pump type as Analog.

- ◆ Leave the Ratio at the default definition (refer to Analog Card Calibration with Dosing Machine, page 117).

3. Go to Configuration > Dosing Configuration.

4. Netafim recommends setting the parameters as shown below. However, you can change these specifics if needed.

△ In case that different dosing pump (electric) or setting (fertilizer meter), refer to *NMC-Pro Advanced Settings*.

△ **Note:** For a more detailed description of this procedure, refer to Section 11.6, Dosing Channel Configuration page, 116.

4.7.8 Dosing Configuration



- ⇒ "7. Dosing Configuration"
- ⇒ EC and PH Control and Alarms to "Yes", only when using EC and pH control
- ⇒ Set Min. On Time of each dosing channel according to the operated device. For example:
 - At NetaJet High Flow it should be 1 sec
 - At NetaJet Inline/Bypass it should be 0.8 sec
- ⇒ Set Min. Off Time of each dosing channel according to the operated device. For example:
 - At NetaJet High Flow it should be 1 sec
 - At NetaJet Inline/Bypass it should be 0.8 sec
- ⇒ To set Control Cycle, run system and measure time in seconds it takes to see reaction of EC/pH meter
- ⇒ Set dosing Booster Delay to 10 seconds (Time booster continues running after dosing process)

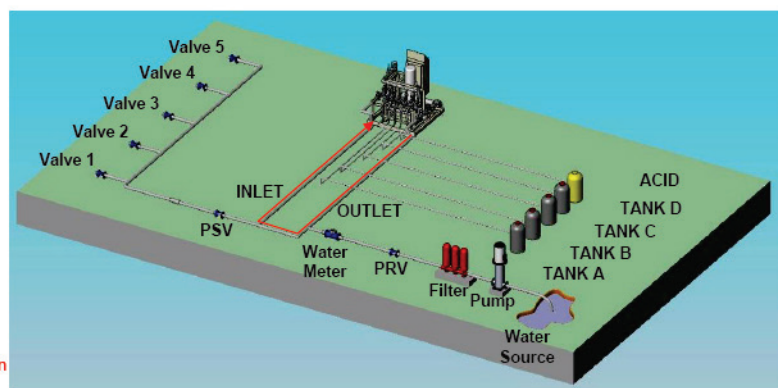

ELECTRICAL INSTALLATION

CONFIGURATION
1. DEVICE DELAY CONFIGURATION
2. PUMP STATION CONFIGURAITON
3. VALVE CONFIGURATION
4. VALVE FLOW RATE
5. WATER METER
6. DOSING CHANNEL CONFIGURATION
7. DOSING CONFIGURATION
8. EC PRE-CONTROL CONFIGURATION
9. DRAINAGE CONFIGURATION
10. SYSTEM PRESSURE CONFIGURATION

DOSING CONFIGURATION	
EC Control	YES
pH Control	YES
EC Alarms	YES
pH Alarms	YES
Minimum On Time (sec)	0.8
Minimum Off Time (sec)	0.8
EC Coarse Tuning	5
EC Fine Tuning	5
pH Coarse Tuning	5
pH Fine Tuning	5
Control Cycle EC	4
Control Cycle pH	4
EC/pH Averaging (0-Low, 20-High)	3
Dosing Boost Off Delay (mm:ss)	00:02
Dosing by QTY. Method	SPREAD

 **Note:** For different dosing settings, refer to *NMC Pro Advanced Settings*

4.7.9 EC/PH Sensor Range

 ⇒ "12. EC/PH Configuration"
⇒ Leave as is unless using non standard EC/pH sensors

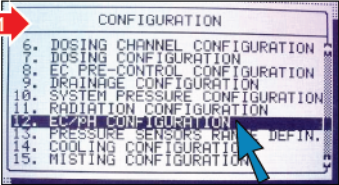
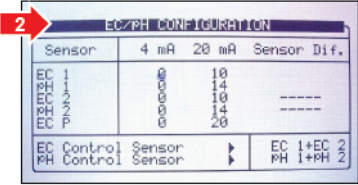



 **Note:** When using multiple EC or pH sensors, refer to *NMC-Pro Advanced Settings*

4.7.10 History Resolution

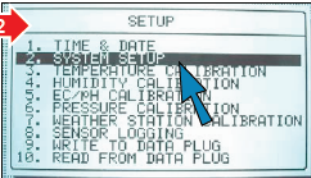
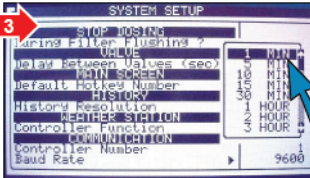
 Program how often computer should collect sensor data. (Keep in mind that lower resolution will quickly fill the memory and overwrite the old data - See *NMC-Pro User Manual*)

 **Note:** For more details on system setup, refer to *NMC-Pro Advanced Settings*

ELECTRICAL INSTALLATION

4.7.11 System Nutrigation™ Check

- EC/pH IS ON Target
- System Nutrigation Simulation
- Water Run Time
- Start/Stop Valve

4.7.11.1.1 EC/pH IS ON Target



Know limits of irrigation system. Calculate max. allowed injection:
 (Dosing channel suction flow ÷ average flow rate from field) X 0.8 =
 Max. injection quantity (lit/m², USA: Gallon/1000 gallon.)

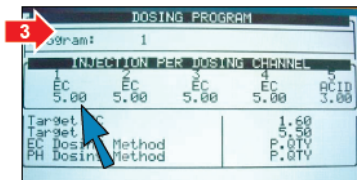
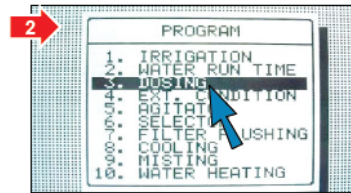
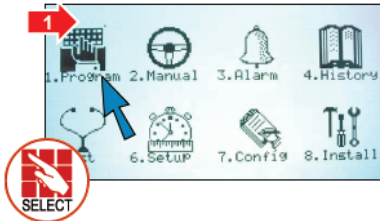

Enter desired amount of fertilizer to inject per dosing channel in l/m² (USA: Gallon/1000 gallon)

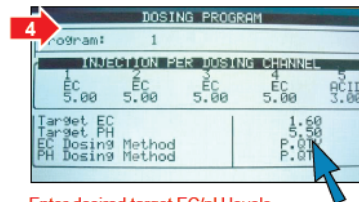

Enter desired target EC/pH levels

4.7.11.1.2 System Nutrigation Simulation



- ⇒ 10 liters of water in bucket
- ⇒ Inject 50 ml of fertilizer from each tank
- ⇒ Inject 30 ml of acid
- ⇒ Mix until acid and fertilizer is dissolved



- ⇒ EC and pH levels.
- ⇒ Results should be relatively close to desired target.
- ⇒ Deviation of ≤ 0.5 from target is allowed.



Use protective equipment, gloves and goggles when handling fertilizers, acid and other chemicals!

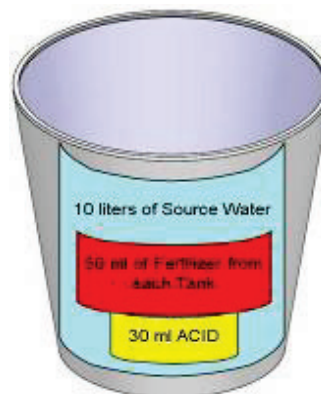

ELECTRICAL INSTALLATION

4.7.11.1.3 Water Run Time

1. Program 2. Manual 3. Alarm 4. History
5. Test 6. Setup 7. Config 8. Install

PROGRAM
1. IRRIGATION
2. DOSEING
3. EST. CONDITION
4. EXCITATOR
5. SELECTOR
6. FILTER FLUSHING
7. COOLING
8. RYSING
9. WATER HEATING

#	Method	Water	Before	After
1	TIME	00:10:00	00:00:00	00:00:00
2	OTV.	0.000	0.000	0.000
3	OTV.	0.000	0.000	0.000
4	OTV.	0.000	0.000	0.000
5	OTV.	0.000	0.000	0.000
6	OTV.	0.000	0.000	0.000
7	OTV.	0.000	0.000	0.000
8	OTV.	0.000	0.000	0.000
9	OTV.	0.000	0.000	0.000
10	OTV.	0.000	0.000	0.000
11	OTV.	0.000	0.000	0.000

SELECT

Enter water run time or quantity

4.7.11.1.4 Start/Stop Valve

1. Program 2. Manual 3. Alarm 4. History
5. Test 6. Setup 7. Config 8. Install

MANUAL OPERATION
1. IRRIGATION PAUSE
2. START/STOP PROGRAM
3. START/STOP VALVE
4. FILTER FLUSHING

START/STOP VALVE
Valve 1
Run Time # 1
Dosing Program 1

SELECT

Run Time Program (1)
Dosing Program (1)

#	Method	Water	Before	After
1	TIME	00:10:00	00:00:00	00:00:00
2	OTV.	0.000	0.000	0.000
3	OTV.	0.000	0.000	0.000
4	OTV.	0.000	0.000	0.000
5	OTV.	0.000	0.000	0.000
6	OTV.	0.000	0.000	0.000
7	OTV.	0.000	0.000	0.000
8	OTV.	0.000	0.000	0.000
9	OTV.	0.000	0.000	0.000
10	OTV.	0.000	0.000	0.000
11	OTV.	0.000	0.000	0.000

DOSING PROGRAM				
Program: 1				
INJECTION PER DOSING CHANNEL				
EC	EC	EC	EC	ACID
5.00	5.00	5.00	5.00	3.00
Target EC				1.50
Target PH				5.50
EC Dosing Method				P.OTV
PH Dosing Method				P.OTV

ACTIVE IRRIGATION

	SET	ACTUAL	LEFT
CYCLE	1	1	0
WATER	00:10:00	00:00:10	00:09:51
FLOW	100.000	100.000	
EC	5.00	5.00	
PH			

PROGRAM: MANUAL 10:48:58 IRRIGATION VALVE: 1 20-Jun-07

PRESS MENU

START/STOP VALVE
Do you really want to start valve 1?
YES NO

STATUS

	Flow	EC	PH
Act. Flow	100.000	Actual	1.6
Target EC		Target	5.5
Chan.	Open(%)	Min(%)	Pr3(%)
Chan. 1	OFF	70	100
Chan. 2	OFF	70	100
Chan. 3	---	---	---
Chan. 4	OFF	70	100

ENSURE

- ⇒ Difference between nominal and actual flow rate is ≤10%
- ⇒ Difference between target and actual EC/pH ≤0.2

ELECTRICAL INSTALLATION

4.7.12 Data Plug

1 Data plug into terminal

2 SELECT

3 ENSURE
System is idle and not in process before "Write to Data Plug"

4 ACTION WILL OVERWRITE EXISTING DATA PLUG
ARE YOU SURE?
YES NO

5 REMOVE
Data Plug from terminal at end of process

5 PROGRAM MENU

In the Main Menu screen, place the cursor on the program icon and press *ENTER*, or press '1' to enter the Program Menu.



- Irrigation, page 55
- Using the Influences, page 59
- Setting the Influences, page 59
- Water Run Time, page 65
- Dosing, page 66
- Ext. Condition, page 68
- Agitator, page 70
- Selector, page 71
- Filter Flushing, page 71
- Cooling, page 72
- Misting, page 74
- Water Heating, page 75

Note: To enter any of the menus, press the corresponding numeric key or scroll to the desired item using the up/down arrow keys and press *ENTER*: a new window will appear. The first menu under Program is Irrigation.

5.1 Irrigation

The Irrigation Program screen includes all the settings for configuring automatic irrigation start. It depends heavily on the Water Run Time and dosing program screens; therefore it is recommended to configure these screens before irrigation takes place.

The NMC-Pro consists of 15 irrigation programs.

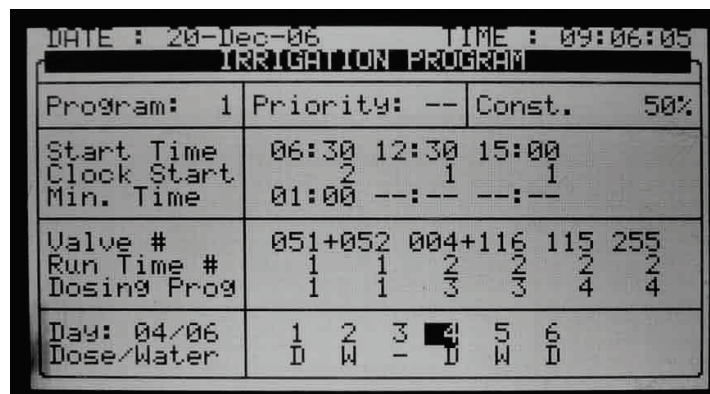

PROGRAM MENU

- **Program:** Select a program by entering the program number and confirm by pressing *ENTER*.
- **Priority:** Priority determines the order in which programs will take place. If start time is the same, higher priority programs come first. Higher priority programs do not stop currently operative programs. If start time and priority are the same, irrigation programs with a lower number are executed first. Priority ranges are between 0 and 15, 15 being the highest (See NMC-Pro Irrigation – Part 2 > Priority specifications for further information).
- Const / Daily / Cond. / Rad Sum / VPD Sum:
 - ♦ **CONST.:** Increase or decrease the amount of water for all valves included in this program. 0% means the quantities will be as specified in the Water Run Time program, 100% will be twice the amount and – 50% will be half the amount specified in the Water Run Time Program. To decrease enter the required percentage of change, press the +/- key and confirm with the ENTER key. The percentage of change is active until you specify otherwise.
 - ♦ **DAILY:** Increase or decrease the amount of water for all valves included in this program. 0% means the quantities will be as specified in the Water Run Time program, 100% will be twice the amount and – 50% will be half the amount specified in the Water Run Time Program. To decrease, enter the required percentage of change, press +/- key and confirm with the ENTER key. The percentage of change will be active only for the present day and will change automatically back to zero on End Day time.

△ **Note:** CONST. % and DAILY % does not change Quantity / time of water before and water after settings, nor dosing quantities.

△ **Note:** When setting watering program and using 'Spread' the percentage affects not only the water but also the dosing.

- ♦ **Cond.:** Specify whether the Condition program can trigger irrigations, and choose a Condition program to start/stop irrigations. Irrigations will be started and stopped according to the settings of the relevant Condition program (see Ext. Condition, page 68, for additional information). If irrigation is not triggered due to Condition program until Max time has elapsed irrigation will be performed due to Max time.

When choosing Condition, the screen will be split in two. To view the day sequence, press the Down arrow when the cursor is placed on the bottom of the screen.

The Condition program has the third priority after active irrigation and uncompleted irrigation (See NMC-Pro Irrigation – Part 2 > Priority specifications for further information).

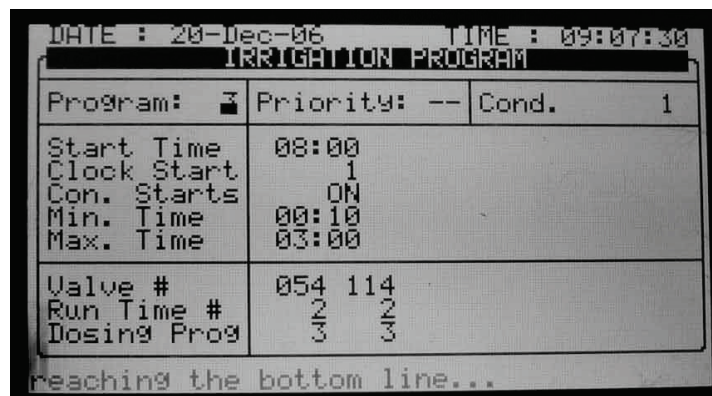

PROGRAM MENU

DATE : 20-Dec-06 TIME : 09:07:43

IRRIGATION PROGRAM

Program:	3	Priority:	--	Cond.	1		
Day: 04/07	1	2	3	4	5	6	7
Dose/Water	D	-	-	-	D	-	-

Screen 2 of 2 - In order to view the

Note: It is impossible to set the same Condition program for two different programs.

- ◆ **Rad Sum / VPD Sum:** Choose whether irrigations can be triggered by the radiation or VPD sum. The specific Rad Sum trigger is specified per period (see [Rad Sum Li.](#)). If irrigation is not triggered due to Rad/VPD Sum until Max time has elapsed irrigation will be performed due to Max time.

DATE : 20-Dec-06 TIME : 09:06:55

IRRIGATION PROGRAM

Program:	2	Priority:	--	Rad Sum
Start Time	07:30	12:00	16:00	
Clock Start	1	--	--	
Rad Sum Li.	200	---	100	
Min. Time	01:00	00:30	--:--	
Max. Time	02:00	--:--	--:--	
Valve #	001	051+052	115	255
Run Time #	1	2	2	2
Dosing Prog	1	2	2	3

Screen 1 of 2 - In order to view the

DATE : 20-Dec-06 TIME : 09:07:08

IRRIGATION PROGRAM

Program:	2	Priority:	--	Rad Sum		
Day: 04/06	1	2	3	4	5	6
Dose/Water	D	-	D	W	D	W

Screen 2 of 2 - In order to view the

Note: When choosing Rad/VPD Sum the screen will be split in two. To view the day sequence, press the Down arrow on the bottom part of the screen.

- **Start time (hh:mm):** ENTER up to six start times (periods) per day for each program.
- **Clock Start:** Set the number of time-based irrigation cycles that will be performed in this cycle. The first cycle starts at the specified start time; subsequent cycles will start after the specified Min. Time.
- **Cond. Starts** (appears only when Cond. Is selected): On/Off.
 - ◆ **On:** Irrigations can be triggered by the Condition program, when the specified Condition program settings are met (Condition program active).
 - ◆ **Off:** Irrigations will not be triggered by the condition program, regardless of the Condition program status.

PROGRAM MENU

- **Rad/VPD Sum Li.:** Specify the radiation/VPD sum limit at which irrigation will take place. The Rad/VPD Sum counter of the specific program is automatically reset when irrigation is performed. If Rad/VPD sum limit is '0' it is ignored.
- **Min. Time:**
 - ♦ In Rad/VPD sum and condition modes determine the minimum time allowed between irrigations.
 - ♦ Even if the Rad/VPD sum limit / condition limit has been reached irrigation will not be performed until that time has passed.
 - ♦ In clock starts the minimum time is the delay between start of a cycle until the start of the next cycle. For example if Clock Start is set to 2, the set Run Time is 30 minutes and the Min. Time is 45 minutes. The second cycle will start 15 minutes after the end of the first cycle.
- **Max. Time:** The maximum time between two subsequent cycles. This value is used to limit the time between two cycles when using dynamic irrigation triggers such as Rad/VPD Sum or the Condition program. When the specified Max. Time from the beginning of the previous cycle has elapsed; irrigation will take place regardless of the Rad/VPD Sum level or the Condition program status.
- **Valve #:** The NMC-Pro can operate valves in any required order. Set the valve number and press enter. The following window will appear:



Select 'blank' and press ENTER to set the valve to operate alone, or '+' (plus) to operate together with the next valve. Several valves can be set to work together, as a group. A valve set (group) will have the same Run Time program and the same dosing program. Each irrigation program can include a maximum of 100 valves (columns) in any required order (all of them together, one after the other, a few groups-max. 100 groups, etc.). The same valve can be entered several times with different settings.

- **Run Time #:** attach a Run Time Program to a valve or a group of valves. When setting valves to work individually, a Run Time Program should be set for each valve. When setting a few valves to work together ("+" mark between them) a Run Time Program should only be set for the first valve, the rest of the valves will follow this setting.

Note: The quantity set in the Run Time Program will be the quantity given for all valves set to operate together, not per valve (for further specifications of the Run Time Program see Water Run Time, page 59).

- **Dosing Program:** Attach a Dosing Program to a valve or a group of valves. When setting valves to work individually, a Dosing Program should be set for each valve. When setting a few valves to work together (with "+" mark between them) a Dosing Program should only be set for the first valve, the rest of the valves will follow this setting.
- **Day (xx/xx):** Allows defining whether the program should irrigate water only, dose or be turned off on different days.
 - ♦ (xx/xx): The right setting defines the day's cycle.
 - ♦ (xx/xx): The left setting defines the current day of the cycle.

Select Dose, Water or None and press ENTER. 'Dose' means Fertigation (water + dosing), 'Water' means irrigation without dosing and 'None' means the program is idle in that day.

DATE : 20-Dec-06		TIME : 09:06:05	
IRRIGATION PROGRAM			
Program:	1	Priority:	-- Const. 50%
Start Time	06:30	12:30	15:00
Clock Start	2	1	1
Min. Time	01:00	--:--	--:--
Valve #	051+052	004+116	115 255
Run Time #	1 1	2 2	2 2
Dosing Prog	1 1	3 3	4 4
Day: 04/06	1 2 3	4 5 6	
Dose/Water	D W -	D W D	

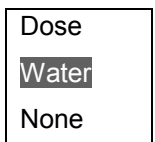

PROGRAM MENU

The figure above shows “Day: 04/06”, meaning the number of the days in the cycle is 6, and the current day is day 4. Day 1 and 5 are set to dose, day 3 is set to irrigate water only, and on days 2, 4 and 6 the program is idle.

5.1.1 Setting Irrigation that is Longer than 24H

If a cycle day is 1 and the irrigation length is over 24 hours, the irrigation will repeat itself continuously, which means continuous irrigation.

Note: Dosing operates according to ('D-W') for the same day and not according to the setting when the irrigation has started. If an irrigation starts at 18:00 and on this day dosing is set ('D'), the irrigation crosses midnight to a day where no dosing is set ('W'), dosing stops at midnight!

5.2 Influence Program

Irrigation Pro enables adjusting irrigation settings according the following factors (labeled “Influences” on the screen):

- Solar radiation
- Amount of drainage
- Amount of fertilizer present in the drainage
- VPD
- Temperature

These Influences can adjust the following irrigation settings:

- EC
- Radiation Sum (RadS)
- Minimum Rest Time (MinT)

For example, a grower may want to increase the EC based on the Solar Radiation. Alternatively, he may want to decrease the MinT based on the drainage.

- Using the Influences
- Setting the Influences

5.2.1 Using the Influences

- Set an Influence to increase or decrease the setting.
- Changes to the setting are in percentages (for example, a 10% increase in the EC level).
- Several Influences adjust the EC setting. The final adjustment amount is based on the sum total of the different Influences.
- You enter up to three points for each Influence setting. Irrigation Pro automatically calculates the curve based on these points.
- You can program up to 15 different programs (corresponding to the 15 irrigation programs)
- After configuring an Influence, you must enable it (under ACTIVE/SOURCE).

5.2.2 Setting the Influences

1. Go to *Install > Device Layout*.
2. Define relays as dosing channels, as required.
3. Go to *Program > Irrigation*.
4. Using the arrow keys, scroll down to Screen 2. The following screen appears.

PROGRAM MENU

DATE: 2 -Feb-12		TIME 12:52-08	
IRRIGATION PROGRAM			
Program: 1	Priority: --	Const. 0%	
INFLUENCE	TABLE	ACTIVE/SOURCE	
Radia./EC	<input checked="" type="checkbox"/>	NO	
Drain/RadS	<input checked="" type="checkbox"/>	NO	
Drain/MinT	<input checked="" type="checkbox"/>	NO	
EC Drain/EC	<input checked="" type="checkbox"/>	NO	
VPD/EC	<input checked="" type="checkbox"/>	NO	
Temp/EC	<input checked="" type="checkbox"/>	NO	

Screen 2 of 2 - In order to view the

5. Select an Influence.

The following sections detail each Influence.

- Radiation Influence on EC, page 60
- Drainage Influence on Target Radiation Sum, page 61
- Drain Influence on Minimum Time, page 62
- Drain Influence on Minimum Time, page 62
- Drainage EC Level Influence on Target EC, page 62
- VPD Influence on Target EC, page 63
- Temperature Influence on Target EC, page 64

5.2.2.1 Radiation Influence on EC

This function enables adjusting the EC based on solar radiation. Solar radiation increases the greenhouse temperature. Adjust the EC according to your crops' requirements.

To set the Radiation Influence:

1. In *Installation > Analog Input*, define a sensor as EC.
2. In *Configuration > Dosing Channel Configuration*, set React to **EC**.
3. In *Configuration > Dosing Configuration > EC Control* to Yes.
4. In *Program > Irrigation*, select **Radia./EC**.
5. Define the Radiation set points (w/m2).
6. Define the EC change in percentages.
7. Set ACTIVE/SOURCE to Yes.
8. Press **Menu** and confirm changes.
9. In *Program > Dosing Program*:
 - a. Set the Target EC
 - b. Set EC Dosing Method to Qty.

Example: As sunlight increases, a crop requires higher EC levels. The following screen illustrates increasing in the EC based on radiation. Since Irrigation Pro calculates the increase in EC proportionally, there will be a 7.5% increase when the radiation reaches 60 w/m2.

PROGRAM MENU

DATE: 2 -Feb-12		TIME 12:52-08	
IRRIGATION PROGRAM			
Program: 1	Priority: --	Const.	0%
INFLUENCE	TABLE	ACTIVE/SOURCE	
Radia./EC	<input checked="" type="checkbox"/>	Radia.	EC
Drain/RadS	<input checked="" type="checkbox"/>	(w/m2)	(%)
Drain/MinT	<input checked="" type="checkbox"/>	40	5
EC Drain/EC	<input checked="" type="checkbox"/>	80	10
VPD/EC	<input checked="" type="checkbox"/>	100	20
Temp/EC	<input checked="" type="checkbox"/>		

Screen 2 of 2 - In order to view the

5.2.2.2 Drainage Influence on Target Radiation Sum

Irrigation can be triggered by the Radiation Sum (Rad Sum). This Influence enables adjusting the Rad Sum based on the amount of drainage.

To set the Drainage Influence on Rad Sum:

1. In *Program > Irrigation*, set Contr. to Rad Sum.
2. In *Installation > Digital Input*, define which digital input is the drain meter.

Note: **The drainage must be defined correctly! You can check the drainage meter status using Hot key 9.**

3. In *Configuration > Valve Configuration* define which valve number corresponds to which drainage meter.
4. In *Configuration > Drainage Configuration*, define the drainage meter's Ratio Liter/Pulse.
5. In *Program > Irrigation*, select Drain/RadS.
 - a. Define the Drainage percentage set points.
 - b. Define the RadS percentage set points.
6. Set ACTIVE/SOURCE to Yes.
7. Press **Menu** and confirm changes.

Example: A user set irrigation to be triggered by the radiation sum. However, he wants to increase the gap between irrigations as drainage increases. The following illustration demonstrates how Rad Sum can increase. When drainage reaches 75%, the Rad Sum increases by 30%. If the Rad Sum Limit were set to 100, than at 75% drainage, it would increase to 130.

DATE: 2 -Feb-12		TIME 12:52-08	
IRRIGATION PROGRAM			
Program: 1	Priority: --	Const.	0%
INFLUENCE	TABLE	ACTIVE/SOURCE	
Radia./EC	<input checked="" type="checkbox"/>	DRAIN%	RadS
Drain/RadS	<input checked="" type="checkbox"/>	(%)	(%)
Drain/MinT	<input checked="" type="checkbox"/>	25	10
EC Drain/EC	<input checked="" type="checkbox"/>	50	20
VPD/EC	<input checked="" type="checkbox"/>	75	30
Temp/EC	<input checked="" type="checkbox"/>		

PROGRAM MENU

5.2.2.3 Drain Influence on Minimum Time

Minimum time defines the minimum break between irrigations. Even if the Rad/VPD sum limit / condition limit has been reached irrigation does not take place until this time has passed. This function enables adjusting the Minimum Time based on the drainage.

To set the Drainage Influence on the Minimum Time:

1. In *Installation > Digital Input*, define which digital input is the drain meter.

Note: The drainage must be defined correctly! You can check the drainage meter status using Hot key 9.

2. In *Configuration > Valve Configuration* define which valve number corresponds to which drainage meter.

3. In *Configuration > Drainage Configuration*, define the drainage meter's Ratio Liter/Pulse.

4. In *Program > Irrigation*, select Drain/MinT.

a. Define the Drainage percentage set points.

b. Define the MinT percentage set points.

5. Set ACTIVE/SOURCE to Yes.

6. Press **Menu** and confirm changes.

Example: When drainage is low, a user wants to decrease the Minimum Time. He sets 20% drainage to a MinT of -25%. As drainage increases, the time between irrigation increases. In this scenario, if the MinT is set to 60 minutes, 40% drainage adjusts the time to 75 minutes.

DATE: 2 -Feb-12		TIME 12:52-08	
IRRIGATION PROGRAM			
Program:	Priority: --	Const.	0%
1			
INFLUENCE	TABLE	ACTIVE/SOURCE	
Radia./EC	<input checked="" type="checkbox"/>	DRAIN%	MinT
Drain/RadS	<input checked="" type="checkbox"/>	(%)	(%)
Drain/MinT	<input checked="" type="checkbox"/>	20	-25
EC Drain/EC	<input checked="" type="checkbox"/>	40	25
VPD/EC	<input checked="" type="checkbox"/>		
Temp/EC	<input checked="" type="checkbox"/>		

5.2.2.4 Drainage EC Level Influence on Target EC

If you have installed an EC sensor in the drainage, you can adjust the EC level based on the drainage EC level. This can be used, for example, to lower the EC level if EC in the drainage are above specifications.

To set the EC Drainage Influence on the EC:

1. In *Installation > Analog Input*:

a. Define a sensor as EC

b. Define a sensor as EC drain

2. In *Installation > Digital Input* define which digital input is the drain meter.

Note: The drainage must be defined correctly! You can check the drainage meter status using Hot Key 9.

3. In *Configuration > Valve Configuration* define which valve number corresponds to which drainage meter.

4. In *Configuration > Dosing Channel Configuration* set React to EC.

5. In *Configuration > Dosing Configuration > EC Control* to Yes.

6. In *Configuration > Drainage Configuration*, define the drainage meter's Ratio Liter/Pulse.

7. In *Program > Irrigation*, select EC Drain/EC.

PROGRAM MENU

- a. Define the EC Drain percentage set points.
- b. Define the EC percentage set points.
8. Set ACTIVE/SOURCE to Yes.
9. Press **Menu** and confirm changes.
10. In *Program > Dosing Program* set the Target EC.

 **Note:** You can disable this function by disabling EC Control (Configuration > Dosing Configuration).

DATE: 2 -Feb-12		TIME 12:52-08	
IRRIGATION PROGRAM			
Program: 1	Priority: --	Const. 0%	
INFLUENCE	TABLE	ACTIVE/SOURCE	
Radia./EC	<input checked="" type="checkbox"/>	EC Drain / EC	
Drain/RadS	<input checked="" type="checkbox"/>	mS/cm (%)	
Drain/MinT	<input checked="" type="checkbox"/>	1 -5	
EC Drain/EC	<input checked="" type="checkbox"/>	2 -10	
VPD/EC	<input checked="" type="checkbox"/>	3 -15	
Temp/EC	<input checked="" type="checkbox"/>		

Screen 2 of 2 - In order to view the

Example: A user wants to maintain an EC level of 1.5. To this end, he measures the drainage EC. When the drainage EC level falls below 1.5, he increases the EC input. As it rises above 1.5 ms/cm, he decreases the EC level.

5.2.2.5 VPD Influence on Target EC

You can adjust the EC based on the VPD Sum (air temperature and humidity). As the VPD rises or falls, the program can increase or decrease the EC level according to your requirements.

1. In *Installation > Analog Input:*
 - a. Define a sensor as EC
 - b. Define an air temperature sensor
 - c. Define a humidity sensor

 **Note:** You can verify the EC status using Hot Key Screen, the temperature and humidity sensors status using Hot Key Screen 6.

2. In *Setup > VPD Sensor Setup*, enable VPD Temperature and VPD Humidity sensors.
3. In *Configuration > Dosing Channel Configuration* set React to EC.
4. In *Configuration > Dosing Configuration > EC Control*, set EC Control to Yes.
5. In *Program > Irrigation*, select VPD/EC.
 - a. Define the VPD sum points.
 - b. Define the EC percentage set points.
6. Set ACTIVE/SOURCE to Yes.
7. In *Program > Dosing Program:*
 - a. Set the Target EC
 - b. Set EC Dosing Method to Pr. Qty.

Example: A grower wants to lower the EC level as the VPD decreases. He sets this screen to reduce the increase in EC level to match the decreasing VPD levels.

PROGRAM MENU

DATE: 2 -Feb-12		TIME 12:52-08	
IRRIGATION PROGRAM			
Program: 1	Priority: --	Const.	0%
INFLUENCE	TABLE	ACTIVE/SOURCE	
Radia./EC	<input checked="" type="checkbox"/>	VPD	EC
Drain/RadS	<input checked="" type="checkbox"/>	(kPa)	(%)
Drain/MinT	<input checked="" type="checkbox"/>	15	7
EC Drain/EC	<input checked="" type="checkbox"/>	10	4
VPD/EC	<input checked="" type="checkbox"/>	5	2
Temp/EC	<input checked="" type="checkbox"/>		

Screen 2 of 2 - In order to view the

5.2.2.6 Temperature Influence on Target EC

You can adjust the EC based on the air temperature. As the temperature rises or falls, the program can increase or decrease the EC level according to your requirements.

1. In *Installation > Analog Input*:
 - a. Define a sensor as EC
 - b. Define an air temperature sensor

Note: You can verify the EC status using Hot Key Screen 4 and the temperature sensor status using Hot Key Screen 6.

2. In *Configuration > Dosing Channel Configuration* set React to EC.
3. In *Configuration > Dosing Configuration > EC Control*, set EC Control to Yes.
4. In *Program > Irrigation*, select Temp/EC.
 - a. Define the Temperature sum points.
 - b. Define the EC percentage set points.
5. Set ACTIVE/SOURCE, select the temperature sensor number.

DATE: 2 -Feb-12		TIME 12:52-08	
IRRIGATION PROGRAM			
Program: 1	Priority: --	NO	0%
INFLUENCE	TABLE	OUT temp	
Radia./EC	<input checked="" type="checkbox"/>	Temp 1	
Drain/RadS	<input checked="" type="checkbox"/>	Temp 2	
Drain/MinT	<input checked="" type="checkbox"/>	Temp 3	
EC Drain/EC	<input checked="" type="checkbox"/>	Temp 4	
VPD/EC	<input checked="" type="checkbox"/>	N/A	
Temp/EC	<input checked="" type="checkbox"/>	NO	

Screen 2 of 2 - In order to view the

6. In *Program > Dosing Program*:
 - a. Set the Target EC
 - b. Set EC Dosing Method to Pr. Qty.

Example: A grower's flower crop requires higher EC levels when the temperature goes above room temperature (22° C). Using this screen, he can adjust the levels accordingly.

PROGRAM MENU

DATE: 2 -Feb-12		TIME 12:52-08	
IRRIGATION PROGRAM			
Program: 1	Priority: --	Const.	0%
INFLUENCE	PRIORITY	ACTIVE/SOURCE	
Radia./EC	<input checked="" type="checkbox"/>	Temp	EC
Drain/RadS	<input checked="" type="checkbox"/>	(°C/F)	(%)
Drain/MinT	<input checked="" type="checkbox"/>	25	2
EC Drain/EC	<input checked="" type="checkbox"/>	27	5
VPD/EC	<input checked="" type="checkbox"/>	30	7
Temp/EC	<input checked="" type="checkbox"/>		

Screen 2 of 2 - In order to view the

5.3 Water Run Time

WATER RUN TIME PROGRAM				
#	Method	Water	Before	After
1	QTY.	11.000	0.300	0.400
2	TIME	01:05:00	00:10:00	00:16:00
3	QTY.	3.000	0.000	0.000
4	QTY.	5.000	0.000	0.000
5	QTY.	6.000	0.000	0.000
6	QTY.	8.000	0.000	0.000
7	QTY.	11.000	0.000	0.000
8	QTY.	12.000	0.000	0.000
9	QTY.	13.000	0.000	0.000
10	QTY.	14.000	0.000	0.000
11	QTY.	16.000	0.000	0.000

The WATER RUN TIME table has 60 “floating” programs; each program can be configured so that irrigation water is given in time (HH:MM:SS) or in quantity (m³ or gallon, depending on definitions in the System Setup, page 98). The programs can later be connected to a valve or a group of valves through the Irrigation Program. Each program includes water, water before and water after settings.

- **Method:** Select the method (QTY. Or Time) with the up/down arrow keys and press ENTER to confirm.
- **Water:** Set quantity / time for each program (liter or gallon). The water setting is the total quantity / time including the Before and After settings.
- **Before:** Set quantity/time without dosing at the beginning of each irrigation cycle.
- **After:** Set quantity/time without dosing at the end of each irrigation cycle.

Note: Before and After settings are deducted from the Water settings. Therefore Water quantity/time must be larger or equal to the Before and After settings.

5.4 Dosing

DOSING PROGRAM				
Program:	1	EC Pre-Control:	ON	
INJECTION PER DOSING CHANNEL				
1	2	3	4	
EC	EC	ACID	PASSIV	---
3.00	5.00	6.00	5.00	---
Target EC				2.00
Target PH				6.00
Target EC Pre-Control				1.80
Passive Dosing Method				QTY.
EC Dosing Method				P.QTY
PH Dosing Method				P.QTY

NMC-Pro includes 10 predefined dosing programs. Each program consists of injection methods, quantities and EC/pH target values. Each channel is completely independent and can be set to give a different amount. Overlapping between the various channels is possible.

- Dosing Program
- Dosing Injection Methods

5.4.1 Dosing Program

- **Program:** Select a program by entering the program number, and confirm by pressing ENTER.
- **EC Pre-Control:**
 - ♦ **On:** EC Pre-Control is active for this Dosing program.
 - ♦ **Off:** EC Pre-Control is not active for this Dosing program; the EC Pre-Control valve will be shifted towards the fresh water source.

INJECTION PER DOSING CHANNEL

- Dosing channel number: 1 to 8.
- **Reaction:** A read only line indicating the purpose of the channel;
 - ♦ **EC:** the channel is used to increase measured EC, meaning it will be opened more when the measured EC is lower than the set EC.
 - ♦ **pH:** the channel is used to decrease measured pH, meaning it will be opened more when the measured pH is higher than the set pH.
 - ♦ **Passive:** the channel does not respond to changes in measured EC/pH, meaning it will be opened as set in the Dosing program regardless of the EC/pH values.
 - ♦ **Alkali:** the channel is used to increase measured pH, meaning it will be opened more when the measured pH is lower than the set pH.
- **Quantity / Time:** Set the Quantity / Time to be injected for each dosing channel. The injection method (proportional, quantity, time, etc.) can be set separately for each use of the channel (EC, pH, Passive).
- **Target EC:** Set the required EC target value, only visible if EC control or EC alarms are active, see table 1.3.
- **Target pH:** Set the required pH target value, only visible if pH control or pH alarms are active, see table 1.3.
- **Target EC Pre-Control:** Set the required EC Pre-Control target value (only visible if EC-Pre Control is set to On, see EC-Pre Control above).
- **Passive Dosing Method:** Set the required injection method of the Passive dosing channels (see [Dosing injection method](#)).
- **EC Dosing Method:** Set the required injection method of the EC dosing channels (see [Dosing injection method](#)).
- **pH Dosing Method:** Set the required injection method of the Acid and Alkali dosing channels (see [Dosing injection method](#)).

PROGRAM MENU

5.4.2 Dosing Injection Methods

1. **P.Qty (1/1000)**: Proportional quantity. Each dosing channel can be set to give a different amount. The set amount is 1 part (Liter or Gallon) fertilizer/Acid per 1000 parts (m³/h or 1000 Gallons) of water.

For example:

- Channel 1 is set to 5.0 (liters or gallons).
- Set water quantity is 3.5 (m³/h or 1000 gallons).

This setting actually means that 5.0 (liters or gallons) of fertilizer will be mixed with each cubic meter (1000 gallons respectively) of water passing through the system.

The total quantity of fertilizer that will be given is $5.0 * 3.5 = 17.5$ liters (Gallons).

2. **P.Time (hh:mm)**: Proportional time. Each dosing channel is given the time to fertilize independently. The NMC-Pro divides this time equally within the given irrigation time (quantity) set in [1.2 WATER RUN TIME](#).

For example:

Dosing channel -1- is set to 00:10, dosing channel -2- is set to 01:00.

Set irrigation time is 03:00 hours.

The NMC-Pro will proportionally divide the set fertigation time for each dosing channel across the set irrigation time (quantity).

Dosing channel -1- will be on for a few pulses; their total time will be 10 min. Dosing channel -2- will be on for a few pulses (not necessarily the same amount). Their total time will be 60 min.

3. **Time. (hh:mm)**: Each dosing channel is given the time to fertigate. Dosing will be done in one bulk that will start after water, before time/quantity has elapsed.
4. **Qty. (Liters or Gallons)**: Quantity. Each dosing channel is given the amount to be injected. Dosing will be done in one bulk or spread throughout the irrigation, depending on settings in the screen [7.7 DOSING CONFIGURATION](#), line [Dosing by QTY. Method](#). Dosing will start after water, before time/quantity has elapsed.

To choose a method, place the cursor on the METHOD column and press ENTER. A small window will appear:

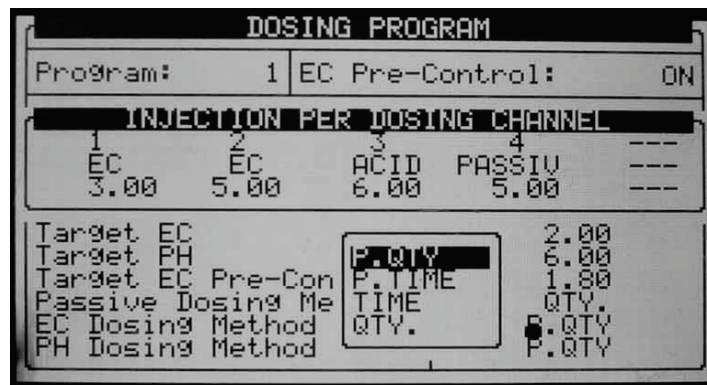

Select the method with the arrow keys and press ENTER to confirm.

Note: The EC/pH columns will not be visible if EC/pH control and EC/pH alarms are marked 'No'.

PROGRAM MENU

5.5 Ext. Condition

The Ext Condition program allows starting and/or stopping irrigation according to dry contacts or analog sensor.

In addition, it is possible to define an output called Cond. This output will be active whenever the condition program settings are met. This enables using the condition program to start any external device.

Refer to Analog Input 1-2, page 126 for details on configuring this window.

EXTERNAL CONDITION PROGRAM			
#	From hh:mm	To hh:mm	Start An. Dry Cont.
1	10:00	12:00	Ana. Sen 1
2	11:00	12:00	Dry Con 1
3	12:00	13:00	Dry Con 1
4	--:--	--:--	<NONE>
5	--:--	--:--	<NONE>
6	--:--	--:--	<NONE>
7	--:--	--:--	<NONE>
8	--:--	--:--	<NONE>

EXTERNAL CONDITION PROGRAM			
#	Trigger Type	Stop An. Dry Cont.	Oper. to Start
1		Ana. Sen 2	---
2	Ana. Sen 1	Dry Con 2	---
3	Ana. Sen 2	Dry Con 14	---
4	Ana. Sen 3	<NONE>	---
5	Ana. Sen 4	<NONE>	---
6	Ana. Sen 5	<NONE>	---
7	Ana. Sen 6	<NONE>	---
8		<NONE>	---

EXTERNAL CONDITION PROGRAM			
#	Oper. to Start	Start Value	Oper. to Stop
1		25	=
2	---	---	---
3	<	---	---
4	<=	---	---
5	=	---	---
6	>	---	---
7	>=	---	---
8	---	---	---

- **From (hh:mm):** Set the start time of the condition program.
- **To (hh:mm):** Set the end time of the condition program

The condition program will only be operational in the defined time window (between start “From” to end “To” times). Each condition program can be operational on different hours.

- **Start An. Dry Con.:** Set the analog sensor or dry contact number for starting the irrigation.
- **Trigger Type:** Choose one of three trigger types:
 - ♦ **One Shot:** If the Start Dry Contact is closed for more than 20 seconds the associated irrigation program will be started. The contact must open and close to initiate irrigation.
 - ♦ **Multi shot:** If the Start Dry Contact is closed for more than 20 seconds the associated irrigation program will be started. If the contact is still closed when the irrigation has finished, irrigation will be initiated.

Note: Notice that the Start Dry Contact does not necessarily have to open and close in order to initiate irrigation. It simply has to be closed when the irrigation has finished.

- ♦ **Only If On:** The associated Irrigation program will be turned on, providing the Start Dry Contact has been closed for more than 20 second and will remain on as long as the contact is closed.
- **Stop An. Dry Con.:** Set the analog sensor or dry contact number for stopping the irrigation. Since the Stop Dry Contact is “stronger” than the Start Dry Contact, the associated irrigation program will not be started as long as the Stop Dry Contact is closed.

The following is a description graph of the Condition program:

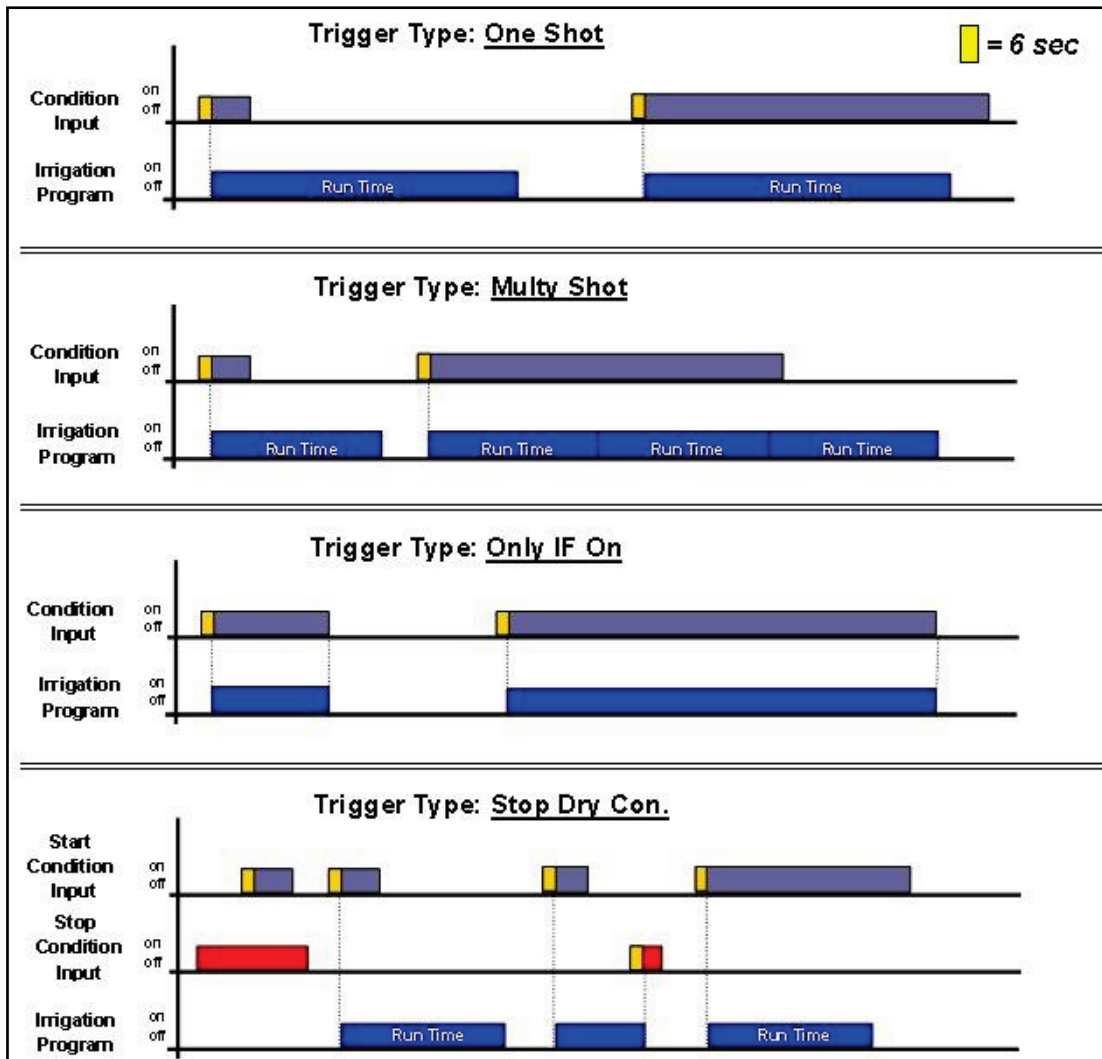

5.5.1 Defining Analog Sensors

1. Go to *Installation > Analog Input 1 (8.4)*.
2. Set Sensors 1 and 2 to the same channels to which the sensors were connected.

ANALOG INPUT No. 1			
	Channel 1	Input Function	No.
Local	1	< None >	--
Local	2	< None >	--
Local	3	< None >	--
Local	4	< None >	--
Local	5	< None >	--
Local	6	< None >	--
Local	7	< None >	--
Local	8	Analog Sensor	1
Local	9	Analog Sensor	2

3. Go to *Setup > Analog Conversion Table*.
4. Define the sensor type (1 = NetSense, 2 = ECh2o 5).

PROGRAM MENU

ANALOG CONVERSION TABLE			
Num.	Sensor Type	Min Value	Max Value
1	NetSense	7.0	45.0
2	ECh20	0.0	60.0

5. Go to *Test > Analog Sensor*.

6. Test the sensor values.

ANALOG SENSOR		
No.	Type	Value
1	NetSense	10.784
2	ECh20	19.355
3	<NONE>	0.000
4	<NONE>	0.000

5.6 Agitator

The agitator is used to mix the fertilizers and acid in the storage tanks in order to prevent the occurrence of sediment.

AGITATOR		
	On mm:ss	Off mm:ss
Dosing Active	01:00	10:00
Dosing Not Active	02:00	30:00

- **Dosing Active:** Definition of the On and Off times of the agitator when dosing is taking place:
 - ♦ **On:** Define the required mixing time.
 - ♦ **Off:** Define the required time between mixing.
- **Dosing Not Active:** definition of the On and Off times of the agitator when dosing is not taking place:
 - ♦ **On:** Define the required mixing time.
 - ♦ **Off:** Define the required time between mixing.

PROGRAM MENU

5.7 Selector

This screen enables the use of various fertilizer stock tanks. Every dosing program can be connected to one (or more) selectors. Using the selector outputs you can choose which fertilizer stock will be connected to each dosing program.

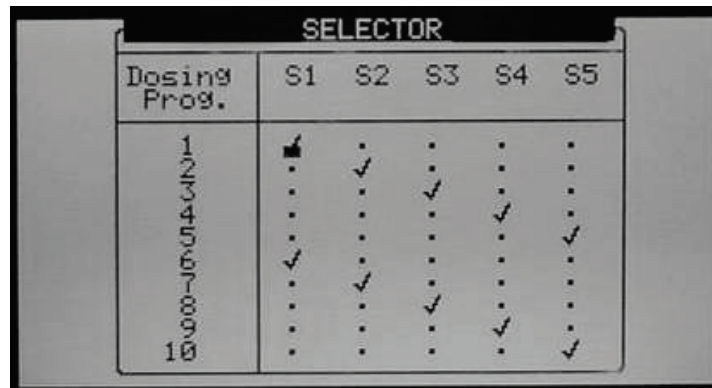

Dosing Prog.	S1	S2	S3	S4	S5
1	•	•	•	•	•
2	•	✓	•	•	•
3	•	•	✓	•	•
4	•	•	•	✓	•
5	✓	•	•	•	✓
6	•	✓	•	•	•
7	•	•	✓	•	•
8	•	•	•	✓	•
9	•	•	•	•	✓
10	•	•	•	•	✓

Use the '+/-' keys to assign a selector to a dosing program.

5.8 Filter Flushing

Configuring the required process for filter flushing is allowed. Define the following before configuring this screen:

- [Stop Irrigation During Filter Flushing](#): Yes/No
- [Stop Dosing During Filter Flushing](#): Yes/No

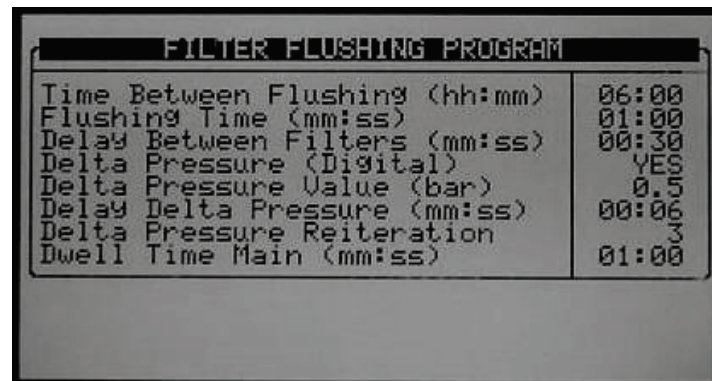

FILTER FLUSHING PROGRAM	
Time Between Flushing (hh:mm)	06:00
Flushing Time (mm:ss)	01:00
Delay Between Filters (mm:ss)	00:30
Delta Pressure (Digital)	YES
Delta Pressure Value (bar)	0.5
Delay Delta Pressure (mm:ss)	00:06
Delta Pressure Reiteration	3
Dwell Time Main (mm:ss)	01:00

- **Time Between Flushing (hh:mm)**: Time interval between two consecutive Flushing cycles. The time is only counted during irrigation.
Example: If the time between flushing is set to 01:00 it means that a flushing cycle will be activated after 1 hour of irrigation (regardless of DP status).
If set to zero (--:--), flushing will only take place if triggered by a DP.
- **Flushing Time (mm:ss)**: Flushing time of each Filter (output).
- **Delay Between Filters (mm:ss)**: The delay time between flushing of one filter to the next. This time is usually used to allow pressure buildup.
- **Delta Pressure (Digital)**: Define whether filter flushing can be triggered due to digital Delta Pressure (Yes / No).
- **Delta Pressure Value (bar)**: Define the Delta Pressure of the inlet pressure sensor (Pin) and outlet pressure sensor (Pout), at which filter flushing will be triggered (Only relevant when the application consists of analog Pin and Pout sensors).
- **Delay Delta Pressure (mm:ss)**: Define the time that the Delta Pressure (digital or value) must be active before a filter flushing cycle will be triggered. This time is usually used to prevent unnecessary flushes from taking place.

PROGRAM MENU

- **Delta Pressure Reiteration:** Number of consecutive filter flushing cycles triggered by the Delta Pressure that can take place without any breaks, before the NMC-Pro will generate an alarm indicating that the Delta pressure sensor is defective. The NMC-Pro will then ignore the Delta Pressure and will continue flushing according to the set Time Between Flushing only, until the alarm is reset.
- **Dwell Time Main Filter Valve (mm:ss):** Define for how much time the main filter valve must be on before the filter flushing cycle is started. This output is typically used to control a pressure-sustaining valve or to start a booster pump.

5.9 Cooling

The Cooling/Humidification program is used to keep the temperature below a set value and/or the humidity above a set value. Each program can be set to maintain temperature or humidity as its first priority.

Five Cooling programs are available with two periods in each program. The periods can be defined to overlap, thus creating “dynamic” cooling or humidification.

Different temperature and humidity sensors can be connected to each program.

The *Status* can be defined as *Cooling* or *Humidification*, the aim of the status field is to help the user to understand the process that should take place by placing the related set point first (i.e. *above t°* when the *status* is *cooling* OR *below RH* when the *status* is *Humidification*)

Note: There are a few steps that should be defined prior to this screen: see *Cooling Configuration*.

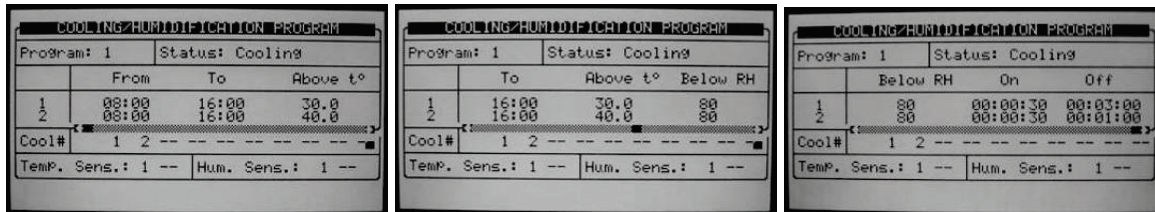

- **Program:** Choose the required program 1 to 8, press ENTER to confirm.
- **Status:** define whether the program’s first priority is maintaining temperature or humidity.
- **Cooling:** the program’s priority is temperature. If the two periods are overlapping and there are different settings in each period, dynamic cooling will take place.

Example:

- Settings:
 - ♦ Period 1 is set between 08:00 to 16:00, The cooling process should work above temperature of 30°C and Below RH of 80%.
 - ♦ Period 2 is set between 08:00 to 16:00, The cooling process should work above temperature of 40°C and Below RH of 80%
 - ♦ On time is fixed to 30 sec in both periods.
 - ♦ Off time is 3:00 minutes which relates to the lowest temperature setting (30°C)
 - ♦ Off time is 1:00 minute which relates to the highest temperature setting (40°C)

Scenarios:

- Time is 10:00, the measured temperature is 35°C and the measured relative humidity is 65%, the cooling valve will be open for 30 seconds and close for 2:00 minutes in a continuous cycle.
- Time is 12:00, the measured temperature is 30°C and the measured relative humidity is 65%, the cooling valve will be open for 30 seconds and close for 3:00 minutes in a continuous cycle.
- Time is 14:00, the measured temperature is 40°C and the measured relative humidity is 50%, the cooling valve will be open for 30 seconds and close for 1:00 minutes in a continuous cycle.
- Time is 15:00, the measured temperature is 35°C and the measured relative humidity is 85%, the cooling valve will not be open since the measured relative humidity is above the maximum allowed (80%).

PROGRAM MENU

△ **Note:** If more than one cooling valve is defined, the off time will take place after the last valve in the sequence (Cooling valve #2, in the above screen). Between the cooling valves there is no delay and they are working in sequence, from the first valve on the left side to the last one.

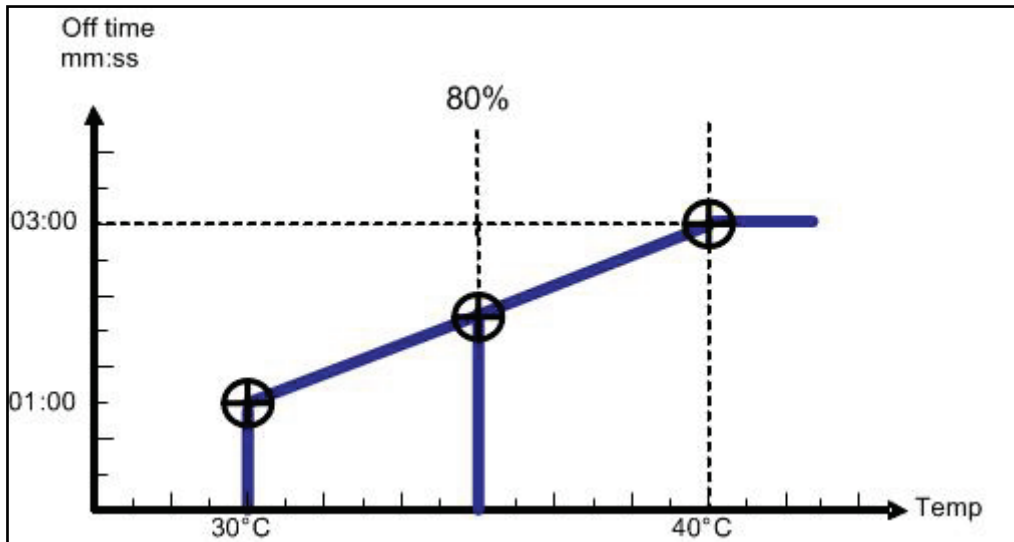

△ **Note:** If the time is relevant only for a certain period, only its settings will define operation. If humidity is above the lowest value of the two periods, cooling will not take place.

- **From (hh:mm):** Set the start time of the Cooling / Humidification program.
- **To (hh:mm):** Set the end time of the Cooling / Humidification program

△ **Note:** The program will only be operational in the defined time window (between start “From” to end “To” times). Each program can be operational on different hours.

- Above t° / Below RH
 - ♦ **Above t°** (when status is cooling): Start cooling above this temperature. Cooling will stop if the temperature drops below the internal dead-band of 0.5°C. For example if set to 30°C cooling will start when the temperature is above 30°C and will stop when it drops below 29.5°C. °
 - ♦ **Below RH** (when status is humidification): Start humidification below this humidity. Humidification will stop if the humidity goes above the internal dead-band of 1%. For example, if set to 80% humidification will start when the humidity is below 80% and will stop when it is above 81%.
- Below RH / Above t°
 - ♦ **Below RH (when status is cooling):** Stop cooling above this humidity. Cooling will be resumed when the humidity drops below the internal dead-band of 2%. For example, if set to 80% cooling will stop when the humidity is above 82% and will be resumed when the humidity drops below 80%.
 - ♦ **Above t°** (when status is humidification): Stop humidification when the temperature is below this temperature. Humidification will be resumed when the temperature goes above the internal dead-band of 0.5°C. For example, if set to 25°C humidification will stop when the temperature drops below 24.5°C and will be resumed when it goes above 25°C.
- **On (hh:mm:ss):** Define the On time of the Cooling valve. If On time is set to zero the Cooling valve will not be opened.
- **Off (hh:mm:ss):** Define the Off time of the Cooling valve. If Off time is set to zero the Cooling valve will be constantly On.
- **Cool #:** Assign cooling valves to this program. The assigned cooling valves will be operated sequentially in groups. The number of groups (different cooling programs) which can be operated simultaneously (maximum cooling parallel) is defined in screen [6.2 SYSTEM SETUP](#).
- **Temp. Sens.:** Assign Up to two temperature sensors for this program.
- **Hum. Sens.:** Assign up to two humidity sensor to this program.

PROGRAM MENU

If there is a malfunction in one of the temperature sensors, a message will be displayed, and that sensor will be taken out of the average temperature calculation. If all the temperature sensors are out of order, the controller will operate according to the first active line. If you would like to operate the program by time only, set as follows:

Set **Status** to cooling or humidification (not important). Set the **Above t°**. and **Below RH** to '0'. Define the required **On** and **Off** times and the program will work accordingly within the set time frame.

5.10 Misting

The misting program is a time scheduler used to open/close a misting valve or any other device that is operated sequentially. Up to 40 misting programs can be preset.

Note that there are a few steps that should be defined prior to this screen, see the Misting Configuration Table on page 122.



#	No.	Start hh:mm	End hh:mm	On hh:mm:ss	Off hh:mm:ss
1	1	08:00	18:00	00:00:30	00:10:00
2	2	10:00	19:00	00:00:50	00:13:00
3	3	11:00	18:00	00:01:00	00:16:00
4	4	08:00	13:00	00:00:55	00:20:00
5	5	09:00	20:00	00:00:18	00:30:00
6	6	10:00	00:00	00:01:02	00:15:00
7	--	--:--	--:--	--:--:--	--:--:--
8	--	--:--	--:--	--:--:--	--:--:--
9	--	--:--	--:--	--:--:--	--:--:--
10	--	--:--	--:--	--:--:--	--:--:--

- **Mist No.:** Assign a mist valve to the program. It is possible to associate the same misting valve to several programs.
- **Start (hh:mm):** Set the start time of the Misting program. If start time is set to 00:00, it will automatically be changed to --:--, meaning the program is not operational.
- **End (hh:mm):** Set the end time of the Misting program. The Misting program will only be operational in the defined time window (between Start to End times). Each Misting program can be operational on different hours.
- **On:** Define the On time of the misting valve. If On time is set to zero the MISTING valve will not be opened.
- **Off:** Define the Off time of the MISTING valve. If Off time is set to zero the MISTING valve will be constantly On.

The table is sorted according to mist number as the first priority, and start time as the second priority. The Mist No. will always appear in groups in an increasing order so that the orientation is quick and easy.

Each mist group has an inside start time sorting, so that a later start is moved to the end of the group. If you delete a row (by zeroing the Mist .No.) it will be moved to the end of the table and the rest of the rows will move one step up. Pressing the menu key does this sorting.

Note: When misting is on all related devices (e.g. misting valve, main valve and pump) are operational. When misting is off, only the pump continues to operate

5.11 Water Heating

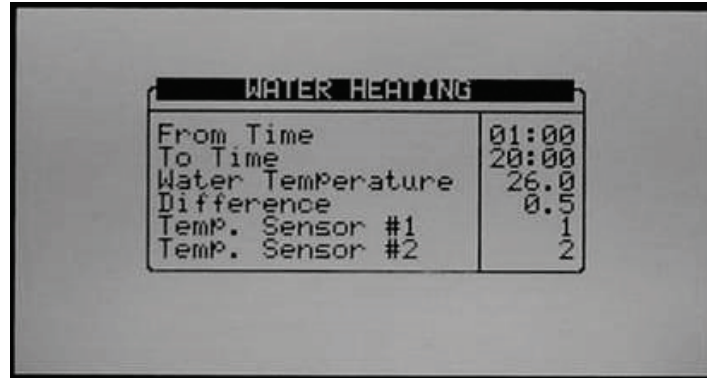

WATER HEATING	
From Time	01:00
To Time	20:00
Water Temperature	26.0
Difference	0.5
Temp. Sensor #1	1
Temp. Sensor #2	2

Water Heating operates according to temperature within a set time frame (between start “From Time” to end “To Time”) and can be used to increase irrigation water temperature or prevent frost.

- **From Time (hh:mm):** Set the start time of the water-heating program.
- **To Time (hh:mm):** Set the end time of the water-heating program.
- **Water Temperature:** Water heating will be activated when the temperature drops below this value.
- **Difference:** Dead-band for stopping water heating. When the water temperature reaches the set Water Temperature + Difference, water heating will be stopped.

For Example: Water temperature is 25°C and the difference is 2°C. Water heating will start when the temperature drops below 25°C and will stop when it is 27° or above.
The Minimum difference is 0.3°C and the default is 0.5°C.

- **Temp. Sensor 1/2:** Assign up to 2 temperature sensors. If you assign 2 sensors, the NMC-Pro will operate according to their average.

6 MANUAL OPERATION MENU

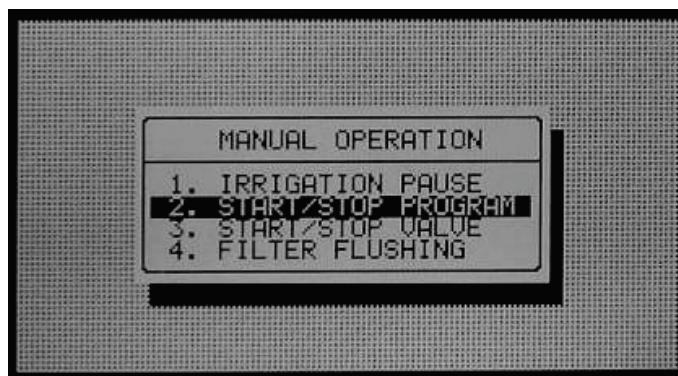

- Irrigation Pause, page 76
- Start/Stop Program, page 76
- Start/Stop Valve, page 77

6.1 Irrigation Pause

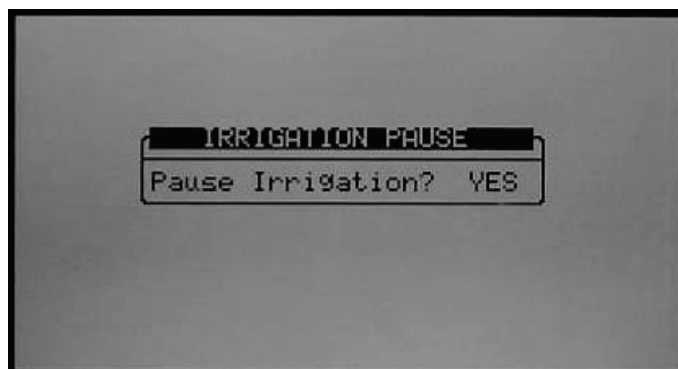

- **Pause Irrigation** (Yes/No): Set Yes and press Enter to confirm; all irrigations will be paused until the value will be set back to No. When the system is released from Pause mode it will complete all irrigations that should have taken place when it was paused.

6.2 Start/Stop Program

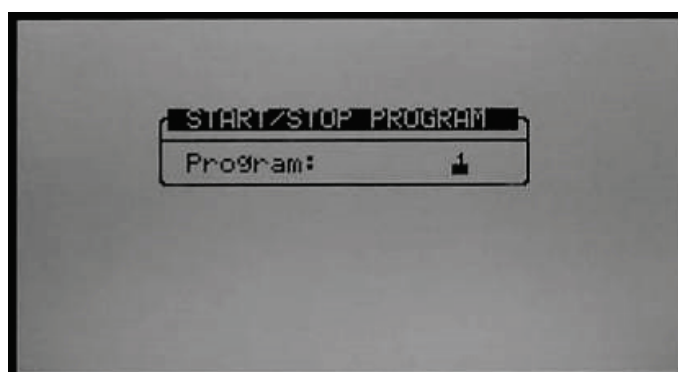

1. Enter a program number to start and press **ENTER**.

ALARM MENU

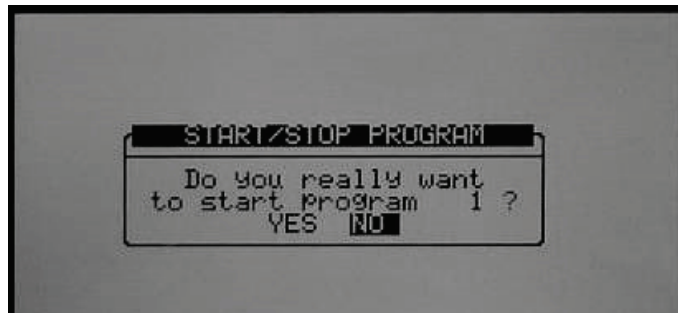

2. Select 'Yes' to confirm your choice and start the relevant program.
3. When you enter the Start/Stop screen during irrigation you will be asked whether you wish to stop the active program. Choose Yes to stop the program.

6.2.1 Start/Stop Valve

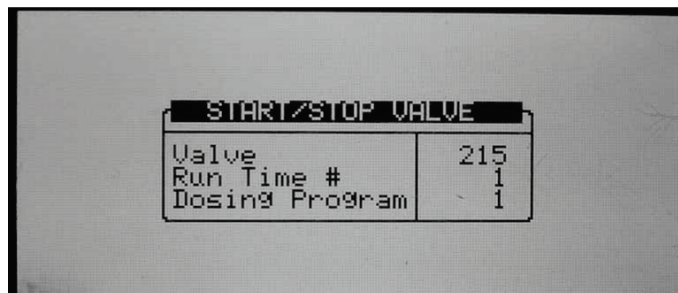

1. Enter a valve number, Run Time program and (optional) dosing program, press Enter to confirm and then press the menu button to open the confirmation screen.

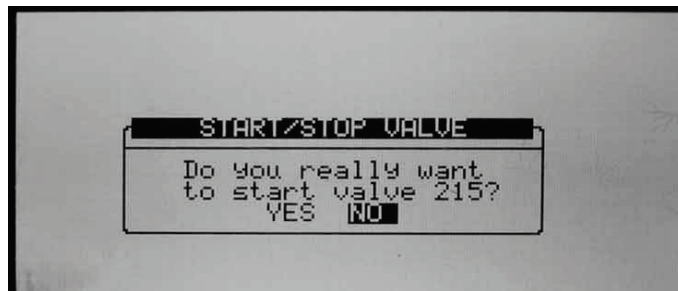

2. Select 'Yes' if you wish to start the relevant valve.
3. When you enter the Start/Stop screen and a valve is active you will be asked whether you wish to stop the relevant valve. Choose Yes to stop the valve.

6.3 Filter Flushing

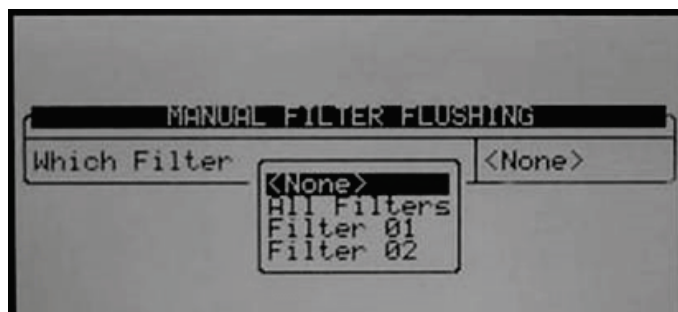

To flush filters manually, follow the prompts, select which filters to flush with the arrow keys and press ENTER to confirm. You can flush all filters or individual filters (without Pump or Main valve operation)

7 ALARM MENU

The Alarm Menu allows configuration of alarms, alarm actions and reset active alarms. It also provides history of previous alarms.

The alarm menu is divided into EC/pH related alarms and none EC/pH related alarms.



- Alarm Reset, page 78
- History, page 79
- Alarm Definition, page 79
- Alarm Setting, page 81
- EC/pH Alarm Definition, page 82
- EC/pH Alarm Setting, page 83
- Radio Sys. Alarm Definition, page 83
- Radio Sys. Alarm View, page 84
- SMS Subscription, page 84

7.1 Alarm Reset

This table shows active alarms and failures. The upper section allows you to cancel failures and reset alarms.

Period of Automatic Reset allows you to set a time in which the NMC-Pro will try to reset the alarms automatically and complete the uncompleted processes.

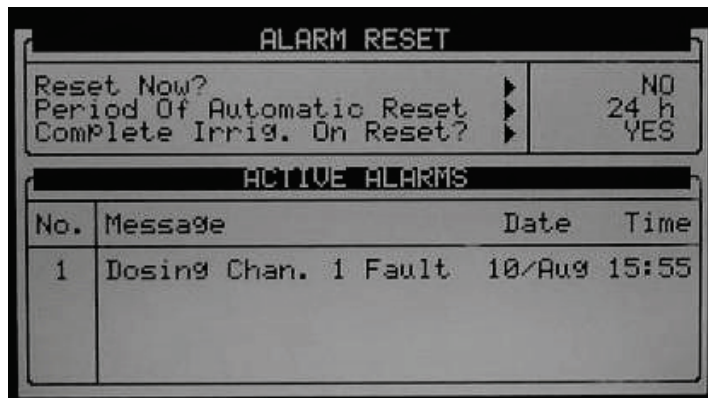

ALARM MENU

7.2 History

Every alarm from the last reset will have a record in this table (Up to 250 alarms).

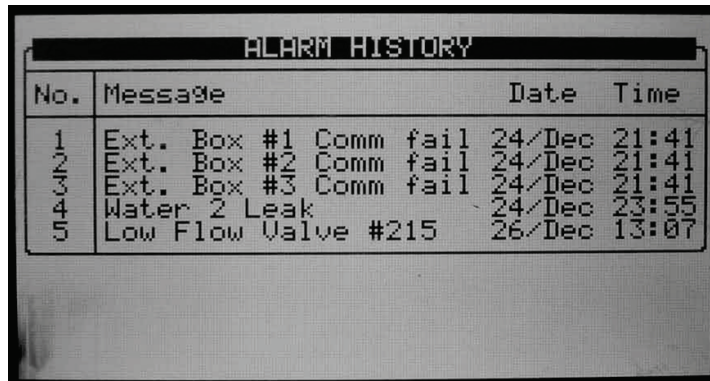

No.	Message	Date	Time
1	Ext. Box #1 Comm fail	24/Dec	21:41
2	Ext. Box #2 Comm fail	24/Dec	21:41
3	Ext. Box #3 Comm fail	24/Dec	21:41
4	Water 2 Leak	24/Dec	23:55
5	Low Flow Valve #215	26/Dec	13:07

7.3 Alarm Definition

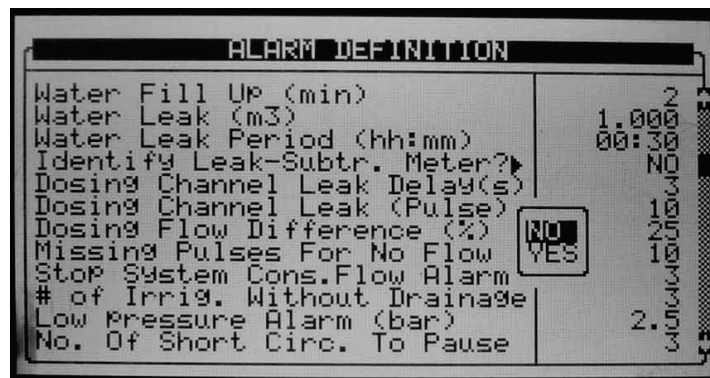

Parameter	Value
Water Fill Up (min)	2
Water Leak (m3)	1.000
Water Leak Period (hh:mm)	00:30
Identify Leak-Subtr. Meter?	NO
Dosing Channel Leak Delay(s)	3
Dosing Channel Leak (Pulse)	100
Dosing Flow Difference (%)	25
Missing Pulses For No Flow	10
Stop System Cons.Flow Alarm	3
# of Irrig. Without Drainage	3
Low Pressure Alarm (bar)	2.5
No. Of Short Circ. To Pause	3

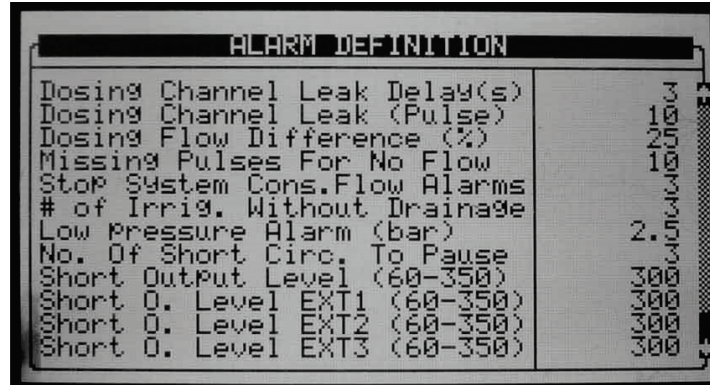

Parameter	Value
Dosing Channel Leak Delay(s)	3
Dosing Channel Leak (Pulse)	100
Dosing Flow Difference (%)	25
Missing Pulses For No Flow	10
Stop System Cons.Flow Alarms	3
# of Irrig. Without Drainage	3
Low Pressure Alarm (bar)	2.5
No. Of Short Circ. To Pause	3
Short Output Level (60-350)	300
Short O. Level EXT1 (60-350)	300
Short O. Level EXT2 (60-350)	300
Short O. Level EXT3 (60-350)	300

- **Water Fill Up (min):** Time for line fill up. The system will ignore high flow and will not generate a High Flow alarm during this period.
- **Water Leak (m3 or Gal):** Quantity of water to trigger a water leak alarm. The quantity is either in m3 or gallon depending on the choice of volume units.
- **Water Leak Period (hh:mm):** Time frame to measure the water-leak quantity. If it takes the system more time than indicated here to measure the water-leak quantity, the system will not generate an alarm.
- **Identify Leak-Subtr. Meter?:** Choose whether to identify (Yes / No) when a water leak occurs in a subtracting water meter (relevant only when operating by water source).
- **Dosing Channel Leak Delay (s):** Delay after dosing channel is stopped before the system starts measuring dosing channel Leak. This feature is usually used to cope with problems regarding hydraulic pumps that work with dosing meters.
- **Dosing Channel Leak (Pulse):** Number of pulses generated by the dosing meter during which the dosing channel should be idle before the system will generate a dosing leak alarm.

ALARM MENU

- **Dosing Flow Difference (%)**: Difference between calculated and measured dosing channel flow above or below which an alarm will be generated. For example, if the calculated dosing channel flow is 100 l/h, and the actual flow is less than 70 l/h or above 130 l/h an alarm will be generated (depending on this parameter's value. This example refers to a parameter set to 30).
- **Missing Pulses For No Flow**: Number of missing pulses before the system will generate a No Flow alarm. The system calculates the expected time between pulses according to the calculated flow rate and the volume per pulse of the water meter, if more time has passed than expected for the set number of missing pulses the system will generate a No flow alarm.
- **Stop System Consecutive Flow Alarms**: Number of consecutive flow alarms of the same type (high flow, low flow etc.) but different valves before the system is stopped. This setting is used to pause the system when there is a general malfunction that occurs in a few valves (or valve groups). The number on the right side of the table indicates the number of consecutive flow alarms. Reaching set point activates a Stop System Consecutive flow alarm.

Warning: When the water meter does not generate pulses and “missing pulses for NO FLOW” or “Max consecutive flow alarms” are in ignore mode, irrigations by quantity will be “stuck” until stopped manually.

- **# of Irrigations Without Drainage**: Number of irrigations given without measuring drainage, above which an alarm will be generated. This alarm usually indicates that the irrigation quantity is too small or that there is a malfunction in the drainage measurement.
- **Low Pressure Alarm (bar/psi)**: Define the minimum allowed pressure, under which an alarm will be generated.
- **Num. Of Short Circ. To Pause**: Number of short circuit alarms measured before the system is paused. This setting is used to pause the system when a general malfunction occurs causing several outputs to short circuit.
- **Short Output Level (60-350)**: Define the A/D threshold value to be considered as a short circuit (for further instructions see NMC-Pro – Part 2 > Appendix 1 – General > Short Circuit Control). ¹

The following parameters will be visible only if an Extension box is defined;

- **Short O. Level EXT1 (60 – 350)**: Define the A/D threshold value to be considered as a short circuit for Extension box no. 1 (for further instructions see NMC-Pro – Part 2 > Troubleshooting > Short Circuit Control).¹
- **Short O. Level EXT2 (60 – 350)**: Define the A/D threshold value to be considered as a short circuit for Extension box no. 2 (for further instructions see NMC-Pro – Part 2 > Troubleshooting > Short Circuit Control).¹
- **Short O. Level EXT3 (60 – 350)**: Define the A/D threshold value to be considered as a short circuit for Extension box no. 3 (for further instructions see NMC-Pro – Part 2 > Troubleshooting > Short Circuit Control).¹

¹ This value is set according to the table 5.1 parameter 'Load output level' parameter.

ALARM MENU

7.4 Alarm Setting

ALARM SETTING				
Description	Irri.	Dose	Delay mm:ss	Alarm Active
High Flow	STOP	STOP	01:00	YES
Low Flow	STOP	STOP	01:00	YES
No Flow	STOP	STOP	-----	YES
D. Ch. Leak	STOP	STOP	30:00	YES
D. Ch. Fault	STOP	STOP	01:00	YES
Ext. Pause	PAUSE	IRRIG.	00:30	YES
D. Boos.Prot.	CONT.	STOP	01:00	YES
Low Pressure	STOP	STOP	01:00	YES
R.U. Error	STOP	STOP	01:00	YES
Host Error	STOP	STOP	01:00	YES

The Alarm Setting table allows you to define the required response for failures recognized by the **NMC-Pro**:

- **STOP**: Stop irrigation and/or dosing for current valve (or valve group) and continue to the next valve (or valve group).
- **CONT**: Continue irrigation and/or dosing for the valve (or valve group) that caused the alarm. This option actually means that the system will generate an alarm but will not take action.
- **Delay (mm:ss)**: Define the period the failure must be active before the NMC-Pro will generate an alarm and will take action.
- **Alarm Active**: Define whether the alarm output should be triggered by the appropriate alarm.

△ **Note**: An alarm will be generated on the NMC-Pro screen even if the NMC has been set to continue (ignore) or the alarm output has been set as not active (or not defined at all).

△ **Note**: The NMC-Pro will not reset a "R.U. Error" alarm once the error has been corrected in the remote unit; the alarm will only be reset upon Period of automatic reset or when reset manually by the user (Reset now function).

△ **Refer to** Analog Output Test, page 45 for information on the Analog Output Test.

7.4.1 Analog Output Alarm Generation

NMC Pro generates Alarm Output Alarms if:

- NMC Pro uses the Dosing Program

DATE : 1-Mar-18		TIME : 15:32:45	
IRRIGATION PROGRAM			
Program:	1	Priority: --	Const. 0%
Start Time	15:06		
Clock Start	10		
Min. Time	00:05		
Valve #	008	009	010
Run Time #	1	1	1
Dosing Prog	1	2	3
Day: 01/01			
Dose/Water	D		

ALARM MENU

- Dosing Program Quantity is defined

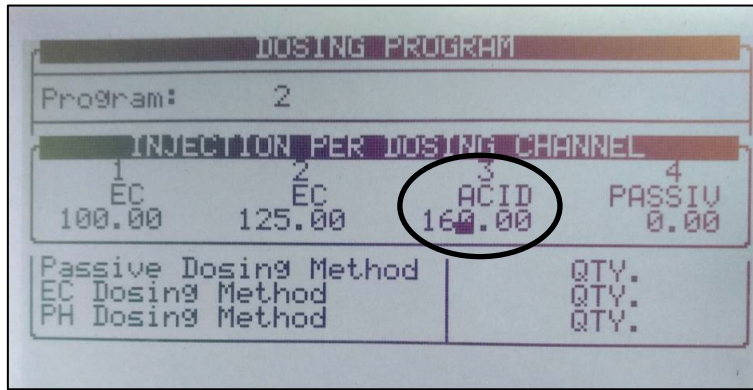

- No analog valve is physically connected

If these three conditions are present:

- NMC Pro ceases the Irrigation-Fertigation
- An alarm appears on the Main Screen

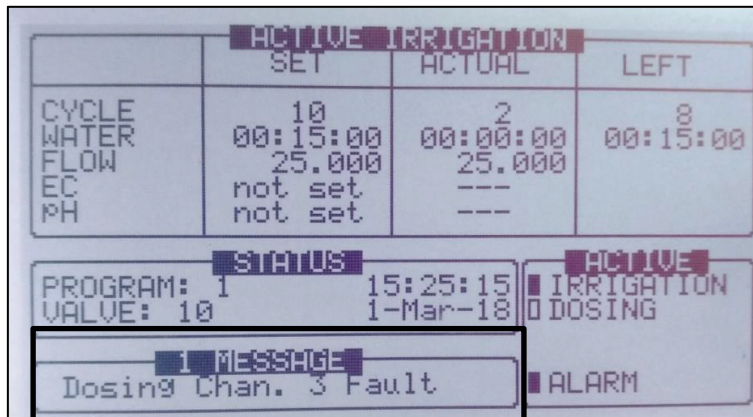

7.5 EC/pH Alarm Definition

EC/PH ALARM DEFINITION	
Delta EC Low	0.5
Delta EC High	0.5
Delta pH Low	0.5
Delta pH High	0.5
Delta EC-Pre Control Low	0.5
Delta EC-Pre Control High	0.5
Emergency EC High (1 Min. Dly)	4.0
Emergency pH Low (1 Min. Dly)	4.5

- **Delta EC Low:** If the measured EC value is lower than the target value minus Delta EC Low, the system will generate a Low EC Alarm.
- **Delta EC High:** If the measured EC value is higher than the target value plus Delta EC High, the system will generate a High EC Alarm.
- **Delta pH Low:** If the measured pH value is lower than the target value minus Delta pH Low, the system will generate a Low pH Alarm.
- **Delta pH High:** If the measured pH value is higher than the target value plus Delta pH High, the system will generate a High pH Alarm.
- **Delta EC Pre-Control Low:** If the measured EC Pre-Control value is lower than the target value minus Delta EC Pre-Control Low, the system will generate a Low EC Pre-Control Alarm.

ALARM MENU

- **Delta EC Pre-Control High:** If the measured EC Pre-Control value is higher than the target value plus Delta EC Pre-Control High, the system will generate a High EC Pre-Control Alarm.
- **Emergency EC High (1 minute delay):** If the measured EC is higher than the value set here for more than 1 minute, the system will be stopped. This setting should be used to protect the plants/system and should generally be higher than the EC High Alarm based on the dosing-program target value plus the Delta EC High.
- **Emergency pH Low (1 minute delay):** If the measured pH is lower than the value set here for more than 1 minute, the system will be stopped. This setting should be used to protect the plants/system and should generally be lower than the pH Low Alarm based on the dosing-program target value minus the Delta pH Low.

7.6 EC/pH Alarm Setting

EC/pH ALARM SETTING				
Description	Irri.	Dose	Delay mm:ss	Alarm Active
EC High/Fail	STOP	STOP	01:00	YES
EC Low	STOP	STOP	01:00	YES
pH High	STOP	STOP	01:00	YES
pH Low/Fail	STOP	STOP	01:00	YES
EC-P.Hi/Fail	STOP	STOP	01:00	YES
EC-Pre. Low	STOP	STOP	01:00	YES
E. Tank Fresh	STOP	STOP	01:00	YES
E. Tank Drain	STOP	STOP	01:00	YES
EC Sen. Dif.	STOP	STOP	01:00	YES
pH Sen. Dif.	STOP	STOP	01:00	YES

The EC/pH alarm setting table allows you to define the desired response for EC/pH related failures recognized by the NMC-Pro:

- **STOP:** Stop irrigation and/or dosing for current valve (or valve group) and continue to the next valve (or valve group).
- **CONT:** Continue irrigation and/or dosing for the valve (or valve group) that caused the alarm. This option actually means that the system will generate an alarm but will not take action.
- **Delay (mm:ss):** Define the period the failure must be active before the NMC-Pro will generate an alarm and will take action.
- **Alarm Active:** Define whether the alarm output should be triggered by the appropriate alarm.

7.7 Radio Sys. Alarm Definition

RADIO SYS. ALARM DEFINITION			
Alarm Type	Delay mm:ss	Active	Inform
RTU			
Vbatt failure	00:00	YES	YES
Vbatt low	00:00	NO	YES
Vbatt warn	00:00	NO	YES
Cap failure	00:00	NO	YES
Card failure	00:00	NO	YES
I/O Open	00:00	NO	YES
I/O Shor	00:00	NO	YES
HOST			
Over current	00:00	NO	YES

IMPORTANT: For Radio System to work properly, **MUST** define in the 6.2 SYSTEM SETUP menu – *Remote Unit type* parameter *SN/RF Net*.

In this screen, define Radio Systems alarm activity and notification.

- **ACTIVE:** Defines if alarm is used in making decisions regarding irrigation program (YES / NO)
- **INFORM:** Defines if the system will notify the user of the alarm occurrence (YES / NO)

ALARM MENU

7.8 Radio Sys. Alarm View

RADIO SYS. Alarm view				
Unit	S/N	Comm	Vin state	Card
HOST	0128	OK	-	-
BASE	0117	FAIL	-	-
RTU	0236	OK	-	3.1
RTU	0115.3.4	-	OK	
RTU	0513.4.1	-	FAIL	
RTU	0198	-	WARN	
RTU	0555.3.1	-	LOW	
RTU	----	-	-	
RTU	----	-	-	
RTU	----	-	-	

In this screen, view the current alarm status of the Radio System.

The **S/N** column is the number of the unit. When an *Open Circuit* or *Short Circuit* alarm is detected, the system in addition will also present the card number and the input/output number that is problematic.

For Example: RTU – 0555.3.1

UNIT # CARD # INPUT/OUTPUT #

Exiting and re-entering refreshes the alarm status screen.

7.9 SMS Subscription

Define which alarms to send for each subscriber. Subscribers need to be defined in the 10.11 Edit SMS Phonebook menu.

SMS SUBSCRIPTION		
Alarm/Group	ADAM	JAKE
*Hardware	PRIORITY	YES
*System VALUE#	PRIORITY	YES
*Hydraulic VALUE#	PRIORITY	YES
*Dosing VALUE#	PRIORITY	YES
HIGH FLOW VALVE#	YES	NO
LOW FLOW VALVE#	YES	NO
WATER LEAK	YES	NO
LOW PRES PRESSOS	YES	NO
DELTA PRESSURE	NO	NO
SYS LOW PRESSURE	YES	YES

Define which subscriber will receive an SMS if there is an active alarm within the listed alarms or group of alarms.

- **NO**: SMS will NOT be sent to this subscriber for this alarm
- **YES**: SMS will be sent to this subscriber in case of an alarm within the time boundary

Note: Time boundary (Send Period) for sending out SMS are define in the **10.12 SMS Setup**

- **PRIORITY**: SMS will be sent to this subscriber in case of an alarm ignoring the time boundary

Note: Verify that the subscriber is defined as ACTIVE in the menu **10.11 Edit SMS Phonebook**.

8 HISTORY MENU

The History Menu provides extensive information regarding measurements and processes performed by the NMC-Pro.



- Irrigation Log, page 86
- RAD. / VPD Sum & Drain Log , page 86
- Uncompleted Irrigation, page 87
- Uncompleted Programs, page 88
- Daily Irrigation, page 88
- Irrigation Accumulation, page 89
- AUX Meter Accumulation, page 89
- Accumulation Reset, page 89
- Filters, page 90
- Cooling, page 90
- Sensors Log, page 91
- Event Log, page 91
- System Log, page 91

HISTORY MENU

8.1 Irrigation Log

The Irrigation Log table includes up to 200 rows of the last irrigations data. Each row includes information regarding a specific irrigation.

- To view additional information, use the left/right arrow keys.
- To switch between dosing quantities or time simply press the '+/-' key.

Date	Time	U1	Reason	Water
23/Dec	17:21	255	Rad Sum	3.671
23/Dec	17:43	254	Rad Sum	0.834
23/Dec	17:43	254	Rad Sum	4.004
23/Dec	17:52	115	Rad Sum	2.504
23/Dec	18:02	219	Rad Sum	0.834
24/Dec	14:50	255	Rad Sum	3.671
24/Dec	15:00	254	Rad Sum	0.834
24/Dec	15:10	115	Rad Sum	4.004
24/Dec	15:20	115	Rad Sum	2.504
24/Dec	15:30	219	Rad Sum	0.834

Date	Time	U1	Duration	Flow
23/Dec	17:21	255	00:10:00	22.000
23/Dec	17:32	254	00:10:00	5.000
23/Dec	17:42	217	00:10:00	24.000
23/Dec	17:52	115	00:10:00	15.000
23/Dec	18:02	219	00:10:00	5.000
24/Dec	14:50	255	00:10:00	22.000
24/Dec	15:00	254	00:10:00	5.000
24/Dec	15:10	115	00:10:00	24.000
24/Dec	15:20	115	00:10:00	15.000
24/Dec	15:30	219	00:10:00	5.000

Date	Time	U1	Chan. 1	Chan. 2
23/Dec	17:21	255	0.5	0.60
23/Dec	17:32	254	0.0000	0.81
23/Dec	17:42	217	0.0000	0.50
23/Dec	17:52	115	0.41	0.44
23/Dec	18:02	219	0.0000	0.81
24/Dec	14:50	255	0.5	0.60
24/Dec	15:00	254	0.0000	0.81
24/Dec	15:10	115	0.41	0.44
24/Dec	15:20	115	0.0000	0.44
24/Dec	15:30	219	0.0000	0.82

- **Date:** Date in which the irrigation started.
- **Time:** Time in which the irrigation started.
- **Valve:** Leading valve; the first valve set for the group of valves
- **Reason:** Specification of the irrigation triggers; time, condition, Rad Sum, etc.
- **Water:** Irrigation quantity (m3 or gallon) or irrigation time.
- **Duration:** Irrigation duration (hh:mm:ss).
- **Flow:** Average flow throughout the irrigation cycle.
- **Chan. #:** Dosing quantities per channel (liter or gallon) or dosing time.
- **EC Low:** Lowest EC value recorded during irrigation.
- **EC Avg.:** Average EC value recorded during irrigation.
- **EC High:** Highest EC value recorded during irrigation.
- **pH Low:** Lowest pH value recorded during irrigation.
- **pH Avg.:** Average pH value recorded during irrigation.
- **pH High:** Highest pH value recorded during irrigation.

△ **Note:** Water quantity is measured in m3 or gallons, duration is measured by time, flow is measured in m3/h or gallon/m, dosing quantity is measured in liters or gallons.

8.2 RAD. / VPD Sum & Drain Log

Date	Time	U1	Reason	Water
20/Dec	17:26	254	Rad Sum	1.400
20/Dec	17:26	217	Rad Sum	1.400
20/Dec	17:26	115	Rad Sum	1.400
20/Dec	17:27	219	Rad Sum	1.400
20/Dec	17:27	255	Rad Sum	1.400
20/Dec	17:28	254	Rad Sum	0.800
20/Dec	17:28	217	Rad Sum	0.800
20/Dec	17:28	115	Rad Sum	0.800
20/Dec	17:29	219	Rad Sum	0.800
20/Dec	17:29	255	Rad Sum	0.800

Date	Time	U1	Drain %	Drain
20/Dec	17:26	254	100.00	1450
20/Dec	17:26	217	92.86	1300
20/Dec	17:26	115	78.57	1100
20/Dec	17:27	219	100.00	1400
20/Dec	17:27	255	----	0
20/Dec	17:28	254	62.50	500
20/Dec	17:28	217	100.00	800
20/Dec	17:28	115	18.75	150
20/Dec	17:29	219	----	0
20/Dec	17:29	255	100.00	850

Date	Time	U1	Rad Sum	Interval
20/Dec	17:26	254	1.400	----
20/Dec	17:26	217	1.400	1
20/Dec	17:27	115	1.400	2
20/Dec	17:27	255	1.400	----
20/Dec	17:28	254	0.800	----
20/Dec	17:28	217	0.800	----
20/Dec	17:28	115	0.800	----
20/Dec	17:29	219	0.800	1
20/Dec	17:29	255	0.800	1

- **Time:** Time irrigation started.
- **Valve:** Leading valve.
- **Reason:** Specification of the irrigation triggers; time, condition, rad sum, etc.
- **Water:** Irrigation quantity (m3 or gallon) or irrigation time.
- **Drain %:** Percentage of drain for relevant irrigation cycle.
- **Drain:** Drain quantity related to relevant irrigation.
- **Rad Sum:** Accumulated radiation sum level when irrigation started.
- **VPD Sum:** Accumulated VPD sum level when irrigation started.
- **Interval:** Time (in minutes) since last irrigation cycle. Refers to the last irrigation of a specific valve.

8.3 Uncompleted Irrigation

The Uncompleted Irrigation table provides information of irrigations that were started but could not be completed due to a failure. To understand why an irrigation was not completed it is advisable to cross-reference between this table and the Alarm History table, page 79. The Uncompleted Irrigation table consists of up to 200 lines. Note that if the letter 'C' appears, it refers to a program that was triggered by condition program.

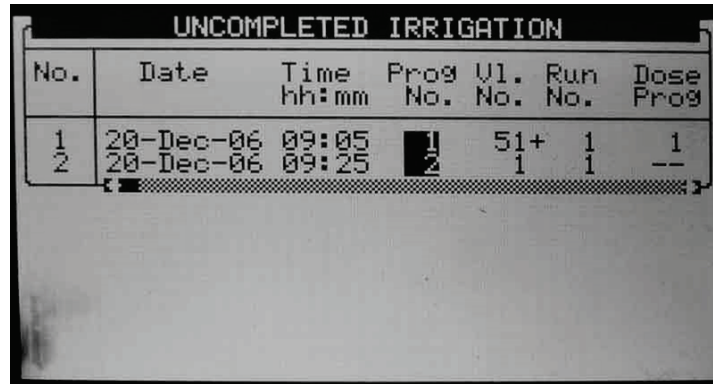

No.	Date	Time hh:mm	Prog No.	Vl. No.	Run No.	Dose Prog
1	20-Dec-06	09:05	1	51+	1	1
2	20-Dec-06	09:25	2	1	1	--

Each line includes information regarding when the irrigation was stopped and added to the uncompleted irrigations table.

- **Date:** Date in which the current line was added to the uncompleted irrigation table.
- **Time:** Time in which the current line was added to the uncompleted irrigation table.
- **Prog. No.:** Program number.
 - ♦ **92:** The program that was added to the table was started manually.
 - ♦ **93:** The relevant irrigation was added to the uncompleted irrigations table for the second time (or more) consecutively.
- **VI. No.:** Indicates the associated valve. If a group of valves that is configured to irrigate together is stopped, only the first valve is written but a '+' sign is added next to it to indicate that more valves are associated. The NMC-Pro will attempt to complete the irrigations from the current day (until end day time) upon manual or automatic alarm reset.
 - ♦ The valve column of irrigations that are to be completed will be highlighted.
 - ♦ The valve column of irrigations that are currently being completed will blink.
- **Run No.:** Indicates the associated run time program.
- **Dose Prog.:** Indicates the associated dosing program.
- **Prog. Qty.:** Planned quantity according to the run time program.
- **Left Qty.:** Uncompleted quantity.

To manually stop an uncompleted irrigation, go to the Start/Stop Valve table, page 77 because the activation is according to single valves.

HISTORY MENU

8.4 Uncompleted Programs

The Uncompleted Programs table provides information on programs that could not be completed. It is important to understand the difference between this table and the Uncompleted Irrigations table; this table consists only of irrigation cycles that haven't been started and could not be completed during the current day. This can happen due to wrong system setup (more tasks than could be completed), or because the system was not active for a long period of time, for example due to a power failure, and could not complete its tasks.

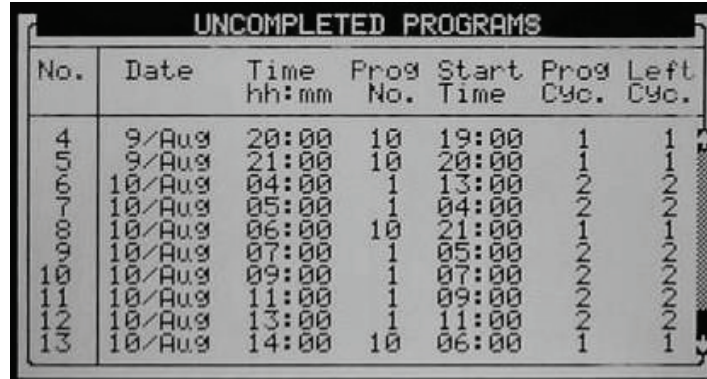

No.	Date	Time hh:mm	Prog No.	Start Time	Prog Cyo.	Left Cyo.
4	9/Aug	20:00	10	19:00	1	1
5	9/Aug	21:00	10	20:00	1	1
6	10/Aug	04:00	1	13:00	2	2
7	10/Aug	05:00	1	04:00	2	2
8	10/Aug	06:00	10	21:00	1	1
9	10/Aug	07:00	1	05:00	2	2
10	10/Aug	09:00	1	07:00	2	2
11	10/Aug	11:00	1	09:00	2	2
12	10/Aug	13:00	1	11:00	2	2
13	10/Aug	14:00	10	06:00	1	1

The uncompleted program table consists of 200 lines.

8.5 Daily Irrigation

This table allows you to view history of irrigation quantities or time per valve.

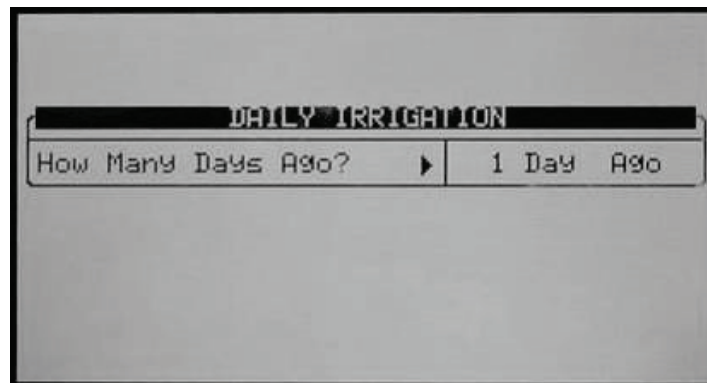

Press *ENTER* to open the selection list, move with the arrow keys to the relevant day and confirm your choice by pressing *ENTER*.

For example, 1 day ago means you would like to view yesterday's history, and Today means you would like to view the accumulated history since the last End Day.

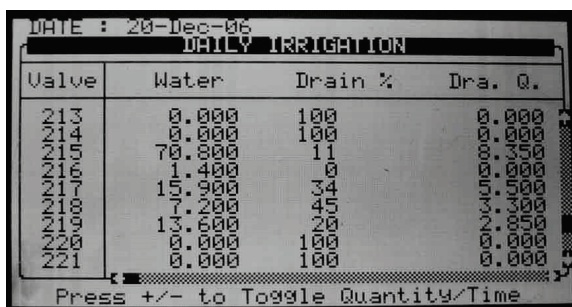

DATE : 20-Dec-06

DAILY IRRIGATION

Valve	Water	Drain %	Dra. Q.
213	0.000	100	0.000
214	0.000	100	0.000
215	70.800	11	0.000
216	1.400	0	0.000
217	15.900	34	0.000
218	7.200	45	0.000
219	13.600	20	0.000
220	0.000	100	0.000
221	0.000	100	0.000

Press +/- to Toggle Quantity/Time

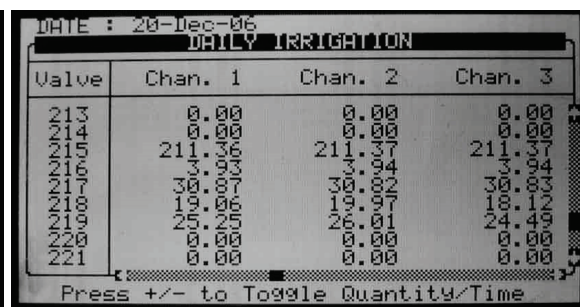

DATE : 20-Dec-06

DAILY IRRIGATION

Valve	Chan. 1	Chan. 2	Chan. 3
213	0.00	0.00	0.00
214	0.00	0.00	0.00
215	211.36	211.37	211.37
216	3.93	3.94	3.94
217	30.87	30.82	30.83
218	19.06	19.97	18.12
219	25.25	26.01	24.49
220	0.00	0.00	0.00
221	0.00	0.00	0.00

Press +/- to Toggle Quantity/Time

The relevant date you are currently viewing will be displayed at the top of the screen.

The Daily Irrigation table contains all water (m3 or gallon) and dosing (liter or gallon). To toggle the view between quantities and time, press the '+/-' key.

HISTORY MENU

8.6 Irrigation Accumulation

The Irrigation Accumulation table allows you to accumulate water and dosing quantities for the required periods. The accumulation of each valve can be reset separately in the Accumulation Reset table.

Valve	Date	Water	Chan. 1
214	20-Dec-06	0.000	0.00
215	20-Dec-06	70.800	211.36
216	20-Dec-06	1.400	3.93
217	20-Dec-06	19.100	35.20
218	20-Dec-06	7.200	19.06
219	20-Dec-06	16.800	29.65
220	20-Dec-06	0.000	0.00
221	20-Dec-06	0.000	0.00
222	20-Dec-06	0.000	0.00

Valve	Chan. 1	Chan. 2	Chan. 3
214	0.00	0.00	0.00
215	211.36	211.37	211.37
216	3.93	3.94	3.94
217	35.20	35.21	35.21
218	19.06	19.97	18.12
219	29.65	30.38	28.86
220	0.00	0.00	0.00
221	0.00	0.00	0.00
222	0.00	0.00	0.00

To toggle the view between quantities and time, press the '+/-' key. Water quantity is measured in cubic meter or gallons; dosing quantity is measured in liters or gallons.

8.7 AUX Meter Accumulation

The Auxiliary Meter Accumulation table allows you to accumulate quantities from meters that do not have designated software, for example, in order to measure the drain water quantity or to measure the cooling system's consumption.

Note: These water meters are accumulators only and are not a part of the irrigation control.

Meter	Quantity	Date
1	4.600	20-Dec-06
2	3.500	20-Dec-06
3	2.200	20-Dec-06
4	2.500	20-Dec-06
5	3.450	20-Dec-06
6	3.600	20-Dec-06
7	5.700	20-Dec-06
8	4.200	20-Dec-06

The quantities displayed are in liters (gallons) up to 9999.999. To reset an auxiliary meter refer to the Accumulation Reset table below.

8.8 Accumulation Reset

ACCUMULATION RESET	
Reset Valve Quantity For?	<None>
Reset Aux. Meter For?	<None>

To reset accumulation of an individual valve or of all valves press the *ENTER* key, choose the relevant option using the arrow keys and confirm by pressing the *ENTER* key.

HISTORY MENU

- △ **Note:** When resetting a valve (or all valves) its history will be erased from the following tables:
- Daily Irrigation
 - Irrigation Accumulation

To reset an individual auxiliary meter or all auxiliary meters press **ENTER**, choose the relevant option using the arrow keys, and confirm by pressing **ENTER**.

- △ **Note:** When resetting an Aux meter (or all Aux meters) its history will be erased from the Aux Meter Accumulation table.

8.9 Filters

The Filters History Table provides daily information of the number and cause of flushing.

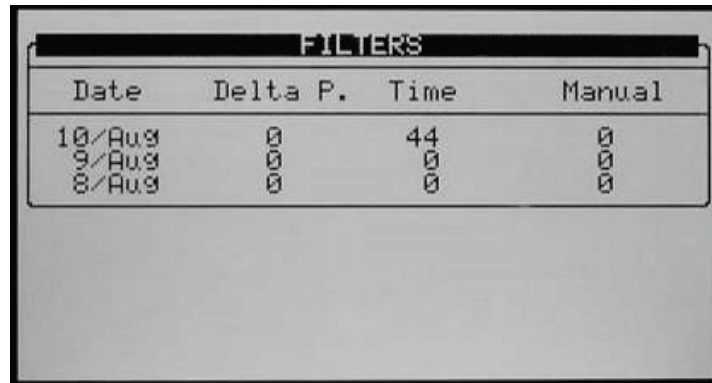

Date	Delta P.	Time	Manual
10/AUG	0	44	0
9/AUG	0	0	0
8/AUG	0	0	0

8.10 Cooling

Use this screen to view cooling history or time per valve.

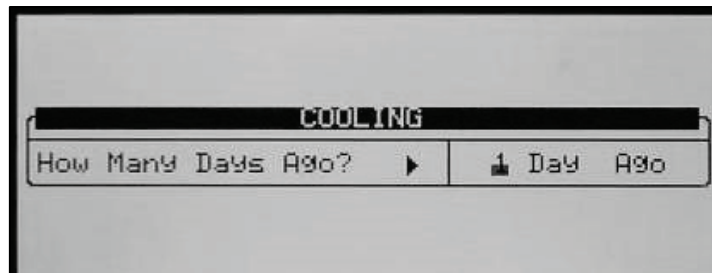

Press **ENTER** to open the selection list, move with the arrow keys to the relevant day and confirm your selection by pressing **ENTER**.

For example, 1 day ago means you would like to view yesterday's history, and Today means you would like to view the accumulated history since the last End Day.

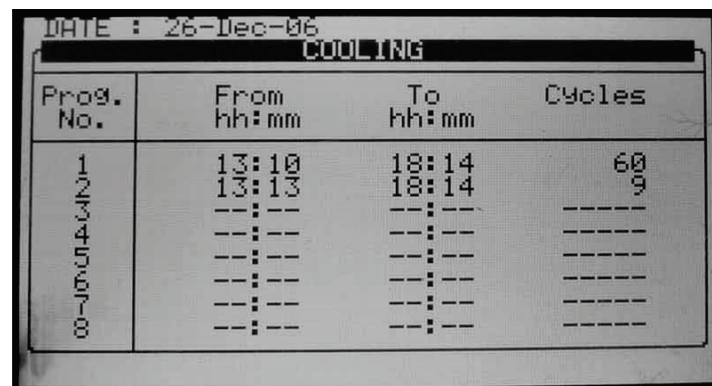

DATE : 26-Dec-06

Prog. No.	From hh:mm	To hh:mm	Cycles
1	13:10	18:14	60
2	13:13	18:14	9
3	--:--	--:--	----
4	--:--	--:--	----
5	--:--	--:--	----
6	--:--	--:--	----
7	--:--	--:--	----
8	--:--	--:--	----

HISTORY MENU

8.11 Sensors Log

The Sensors Log Table includes history of average measurements of logged sensors. To define which sensors should be logged and the averaging interval refer to table 6.2.

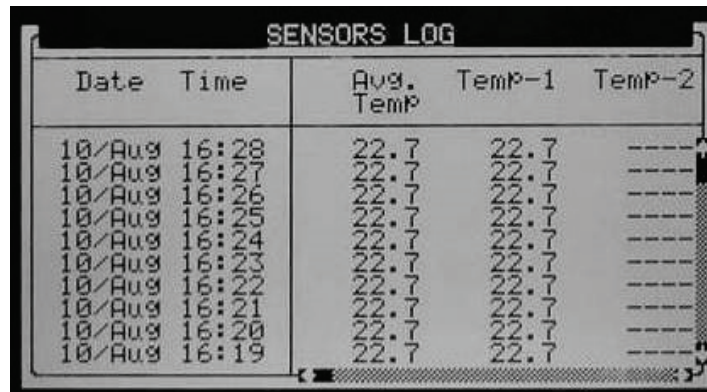

Date	Time	Avg. Temp	Temp-1	Temp-2
10/Aug	16:28	22.7	22.7	----
10/Aug	16:27	22.7	22.7	----
10/Aug	16:26	22.7	22.7	----
10/Aug	16:25	22.7	22.7	----
10/Aug	16:24	22.7	22.7	----
10/Aug	16:23	22.7	22.7	----
10/Aug	16:22	22.7	22.7	----
10/Aug	16:21	22.7	22.7	----
10/Aug	16:20	22.7	22.7	----
10/Aug	16:19	22.7	22.7	----

The Sensors Log Table contains up to 10,000 data fields. Date and time are two fields per line and every sensor is an additional field. For example: logging of two sensors uses four data fields; two for time and date and one for each sensor. In this case, the table will consist of a maximum of 2,500 lines.

8.12 Event Log

The table provides information of all the processes performed by the NMC-Pro including their time and date.

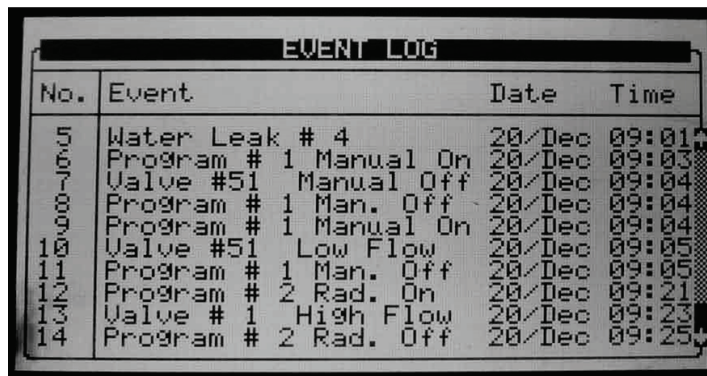

No.	Event	Date	Time
5	Water Leak # 4	20/Dec	09:01
6	Program # 1 Manual On	20/Dec	09:03
7	Valve #51 Manual Off	20/Dec	09:04
8	Program # 1 Man. Off	20/Dec	09:04
9	Program # 1 Manual On	20/Dec	09:04
10	Valve #51 Low Flow	20/Dec	09:05
11	Program # 1 Man. Off	20/Dec	09:05
12	Program # 2 Rad. On	20/Dec	09:21
13	Valve # 1 High Flow	20/Dec	09:23
14	Program # 2 Rad. Off	20/Dec	09:25

The table consists of the last 999 events.

8.13 System Log

This table provides information of all the system changes. Examples of system changes are changes of triggered by the controller, the PC communication, a power off, etc.

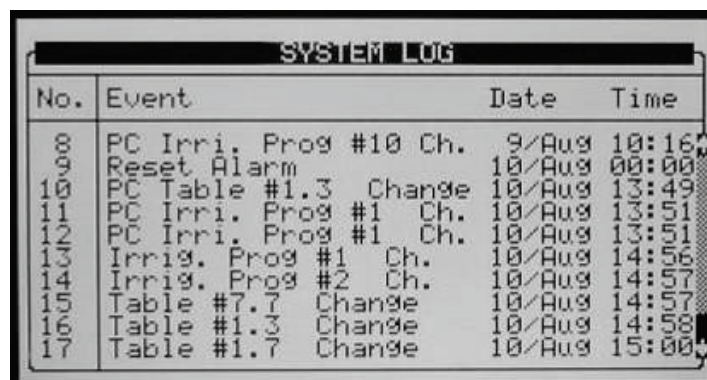

No.	Event	Date	Time
8	PC Irri. Prog #10 Ch.	9/Aug	10:16
9	Reset Alarm	10/Aug	00:00
10	PC Table #1.3 Change	10/Aug	13:49
11	PC Irri. Prog #1 Ch.	10/Aug	13:51
12	PC Irri. Prog #1 Ch.	10/Aug	13:51
13	Irrig. Prog #1 Ch.	10/Aug	14:56
14	Irrig. Prog #2 Ch.	10/Aug	14:57
15	Table #7.7 Change	10/Aug	14:57
16	Table #1.3 Change	10/Aug	14:58
17	Table #1.7 Change	10/Aug	15:00

The table displays of the last 999 events.

9 TEST MENU

TEST	
1.	RELAYS
2.	DIGITAL INPUT
3.	ANALOG INPUT
4.	TEMPERATURE
5.	HUMIDITY
6.	ANALOG SENSOR
7.	HARDWARE CHECKLIST
8.	ANALOG OUTPUT

The Test menu provides a quick way of verifying functionality.

- Relays, page 92
- Digital Input, page 93
- Analog Input, page 94
- Temperature, page 94
- Humidity, page 95
- Hardware Check List, page 95
- Analog Output Test, page 96

9.1 Relays

The Relays Test screen allows you to check the current output status and verify proper operation.

TEST RELAYS			
OUTPUT#	FUNCTION		STATUS
1	Dosing Channel	1	OFF
2	Dosing Channel	2	OFF
3	Dosing Channel	3	OFF
4	Dosing Channel	4	OFF
5	Dosing Channel	5	OFF
6	Dosing Channel	6	OFF
7	Dosing Channel	7	OFF
8	Dosing Channel	8	OFF

Press ENTER to Manual Operation.
LOCAL Load Output Level (A/D): 0

TEST RELAYS			
OUTPUT#	FUNCTION		STATUS
126	None	0	OFF
127	Same As Relay	11	OFF
128	Valve	54	OFF
129	Valve	115	OFF
130	Valve	116	OFF
131	Valve	117	OFF
132	None	0	OFF
133	None	0	OFF

Press ENTER to Manual Operation.
EXT1 Load Output Level (A/D): 0

TEST MENU

OUTPUT#	FUNCTION		STATUS
249	None	0	OFF
250	None	0	OFF
251	None	0	OFF
252	None	0	OFF
253	None	0	OFF
254	None	0	OFF
255	Same As Relay	13	OFF
256	Valve	255	OFF

Press ENTER to Manual Operation.

EXT3 Load Output Level (A/D): 0

The setting switches automatically between ON and Off depending on device actual status.

To manually test relay functionality, move the cursor to required device using the arrow keys and press **ENTER**; the device is turned on and the setting will show Man.

Press **ENTER** again to return to automatic operation.

- **OFF**: The output is not active.
- **ON**: The output is automatically turned on by the relevant program.
- **Man**: Manual operation of the output. The manual operation resets after 30 minutes of being idle, to prevent you from forgetting to set it back to automatic operation.
- **Load Output Level**: Output level in A/D values. The value is constantly updated in accordance to relay operation and output level change. This value is used to calculate the A/D threshold value to be considered as a short circuit.

9.2 Digital Input

The Digital Input test screen allows you to verify the proper operation of digital inputs and sensors. Digital inputs are defined as meters (water meters, dosing meters, etc.) that count the number of closed contacts from 0 to 255 and automatically restart back from 0. Other digital inputs (Dry contact, Ext. Pause, etc.) show either 0 when the contact is open or 1 when the contact is closed.

Note that the card number is set according to its jumpers regardless to its location (local or extension box).

Channel	Card No. 1	Card No. 2	Card No. 3	Card No. 4
1	59	28	37	39
2	0	0	0	0
3	0	0	0	0
4	0	0	0	0
5	0	0	0	0
6	0	0	0	0
7	0	0	0	0
8	0	0	0	0

TEST MENU

9.3 Analog Input

Analog inputs will show values from 0 to 1023.

Channel	Card No.1	Card No.2
1	439	791
2	216	846
3	231	859
4	552	1022
5	240	1005
6	405	1010
7	320	1011
8	350	1013
9	383	318
10	5	248
11	1001	786

Sensor type	Description
pH sensor	pH = 0 – A/D = 205
	pH = 7.0 – A/D = 615
	pH = 14.0 – A/D = 1023
EC sensor	EC = 0 – A/D = 205
	EC = 2.0 – A/D = 370
	EC = 10.0 – A/D = 1024
Humidity sensor	RH% = 0 – A/D = 0
	RH% = 50 – A/D = 308
	RH% = 100 – A/D = 620
Temp sensor	T°C = 0 – A/D = 768
	T°C = 25 – A/D = 489
	T°C = 50 – A/D = 250

9.4 Temperature

This table shows the current temperature sensor readings in degrees (Celsius or Fahrenheit depending on the setup in the screen).

No.	Value
1	22.8
2	----
3	----
4	----
5	----
6	----

9.5 Humidity

This table shows the current humidity sensor readings in percentage relative humidity.

HUMIDITY	
No.	Value
1	55.3
---	---
---	---
---	---
---	---
---	---

9.6 Hardware Check List

The Hardware Checklist displays which and how many output and input cards are connected and where they are connected; local, or in one of the extension boxes. Position of cards connected locally will appear on the bottom table.

HARDWARE CHECKLIST					
DESCRIPTION	LOC.	EXT1	EXT2	EXT3	
Analog Input	2	0	0	0	
Digital Input	1	1	1	1	
Relay Card	5	3	8	3	
Ext. Box Version	-	1.01	1.01	1.01	

COM.	Relay 64+57	---	A.In No.2	A.In No.1	D.In No.1
Relay 1+8	Relay 9+16	Relay 17+24	Relay 25+32	---	P.S.

To update the Hardware Checklist, disconnect the NMC-Pro from the power supply or perform a cold start procedure.

The bottom row shows 24 VAC output cards, dry contact output cards and power supply. The upper row shows dry contact output cards, analog and digital input cards, and communication card.

Note: Notice that in the large boxes this table should be turned left to see actual cards position. For example the communication card (COM.) will actually be on the bottom left side of the box.

9.7 Analog Output Test

The Analog Output test screen enables testing the valves' opening, both while in operation or off-line. The test shows:

- The amount of current going to the valve
- Test results

From these data points, the user can troubleshoot a faulty valve.

ANALOG OUTPUT				
N#	Status	Open%	Meas	Fail
1	AUTO	70	54.00	ON
2	AUTO	70	4.00	ON
3	MAN	50	10.50	OFF
4	MAN	70	14.00	OFF
5	AUTO	60	12.00	OFF
6	AUTO	60	12.00	OFF
7	AUTO	60	12.00	OFF
8	AUTO	60	12.00	OFF

- Define and map the analog output card(s) in Analog Output, page 129.
- Configure dosing in Dosing Configuration, page 119.

To test the analog output valves:

- Under Status, select one of the following:
 - ♦ **AUTO**: PRO Irrigation tests the valve opening percentage. Use this option while the controller is operating.
 - ♦ **MAN**: The user defines the valves' opening percentage.
- The screen displays the test results:
 - ♦ **Meas**: This field displays the amperage used to open the valve, from 4 - 20 mA. 4 corresponds to closed completely (0%) and 20 corresponds to open completely (100%).
 - ♦ **Fail**:
 - ON: The valve is not operating properly
 - OFF: The valve is operating properly
- Troubleshooting:
 - ♦ If the test fails and there is high amperage, the card is installed improperly (Number 1 in the above figure).
 - ♦ If the test fails and there is no amperage (4.00), there is a short circuit (Number 2 in the above figure).

10 SETUP

The Setup Menu provides clock, calibration; plug storage/retrieval and language settings.

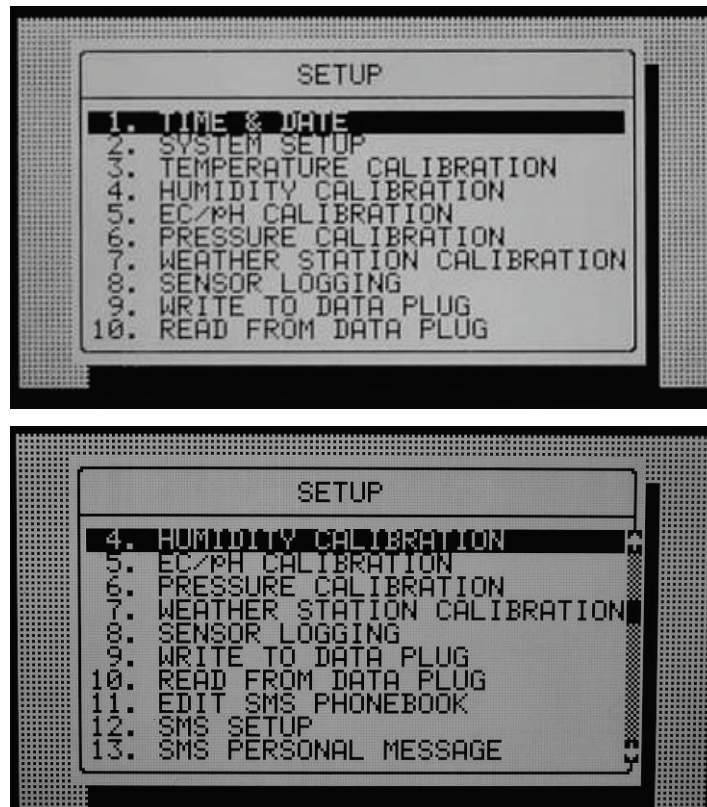

- Setup, page 97
- Time & Date, page 98
- System Setup, page 98
- Temperature Calibration, page 101
- Humidity Calibration, page 101
- EC/pH Calibration, page 102
- Pressure Calibration, page 104
- Weather Station Calibration, page 104
- Sensors Logging, page 105
- Write to Data Plug, page 105
- Read from Data Plug, page 106
- Edit SMS Phonebook, page 107
- SMS Setup, page 107
- SMS Personal Message, page 108

SETUP MENU

10.1 Time & Date

The Time & Date screen allows you to set the current time and date as well as the end of the crop daytime.

To adjust the time and date, place the cursor on the setting you wish to modify, change the numbers using the keypad and press ENTER to save your changes.

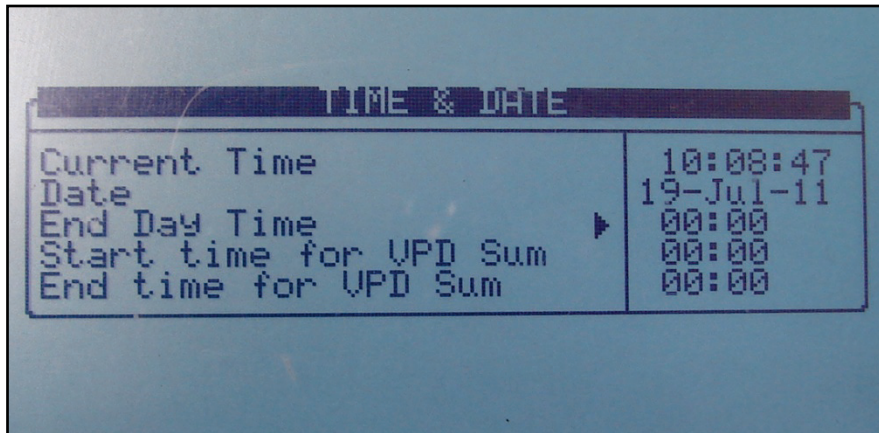

- **End Day Time:** Select the start time of a new day 00:00 to 23:00. At End Day time:
 - ♦ All the alarms are reset.
 - ♦ All the uncompleted irrigations are reset. Irrigation cycles that haven't been completed will move to the Uncompleted Programs table, page 88.
 - ♦ All the valves that are registered in the uncompleted programs table and did not complete the irrigation are switched from Wait position to Do Not Continue (Move to history).
 - ♦ Cycle days in the PROGRAM table are moved one day ahead.
 - ♦ The daily % change is zeroed (the constant % change stays the same).
 - ♦ Currently active cycle will continue with its current settings until completed.
- **Start/End time for VPD Sum** – Set the time frame for the VPD Sum counter.
 - ♦ Only during this time frame will the VPD be summed
 - ♦ At **End time for VPD Sum**, the counter is reset

10.2 System Setup

The System Setup screen includes all general system settings.

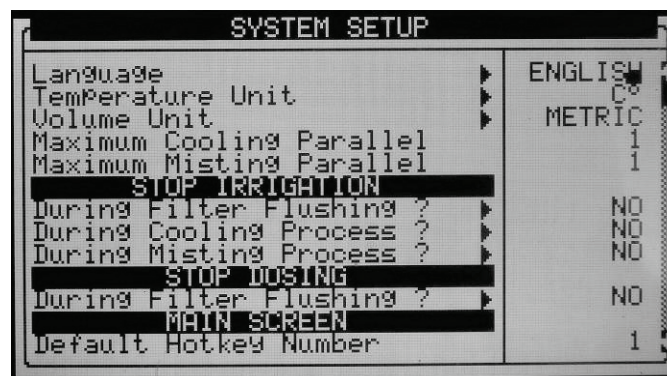

SETUP MENU

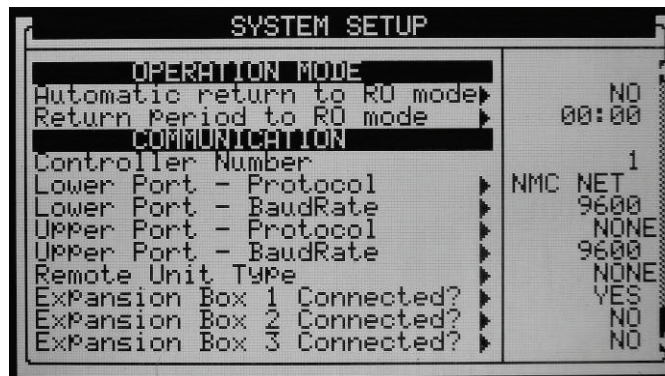
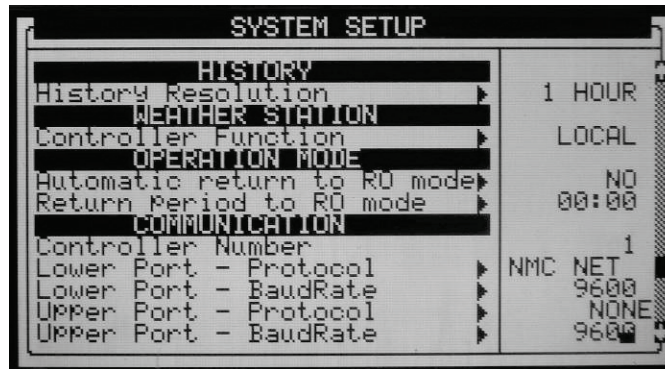

- **Language:** Choose controller language.
- **Temperature Unit:** Celsius or Fahrenheit.
- **Volume Unit:** Metric (m3 & Liter) or Gallon. These units also influence the pressure measurement units; when choosing metric pressure, measurement will be in bar, when choosing gallon pressure, measurement will be in PSI.
- **Maximum Cooling Parallel:** Define the maximum number of cooling programs to be operated simultaneously. The maximal possible number is 8.

Note: This number refers to the number of cooling programs that will be operated in parallel; valves from the same cooling program will always be operated sequentially.

- **Maximum Misting Parallel:** Define the maximum number of misting valves to be operated simultaneously. The maximal possible number is 40.

STOP IRRIGATION

- **During Filter Flushing:** Define whether irrigation should be stopped during filter flushing.
- **During Cooling Process:** Define whether irrigation should be stopped during cooling.
- **During Misting Process:** Define whether irrigation should be stopped during misting.

STOP DOSING

- **During Filter Flushing:** Define whether dosing should be stopped during filter flushing.

MAIN SCREEN

- **Default Hotkey Number:** Define the required default hotkey number. When the system is idle for a few minutes the controller will automatically switch to the default hotkey (hot-screen)

HISTORY

- **History Resolution:** Set the history collection rate of the sensors. For example if set to 15 minutes, the controller will collect data from the defined sensors every 15 minutes (see **10.8 Sensors Logging** for configuring which sensors / data is collected).

WEATHER STATION

- **Controller function:** Define whether this controller is connected to a weather station directly or through the network.
 - ♦ **Local:** A weather station is connected to this controller; its data is used locally only and should not be passed or received through the network.
 - ♦ **Slave:** This controller receives weather station data through the network; the data is collected by another NMC-Pro (or NMC-64 Climate), which is connected directly to a weather station defined as Master. Sensors connected directly to a slave controller will be used by it and will have a higher priority than those transmitted by the master.
 - ♦ **Master:** A weather station is connected to this controller and its data should be transmitted through the network to other controllers. There can be only one master controller of any type in each network.

OPERATION MODE

- **Automatic return to RO mode:** Define if the controller will return automatically back to the Read Only mode after a certain period of time.
- **Return Period to Read Only mode:** Set the amount of time for the controller to return automatically to the Read Only mode (mm:ss).
This parameter is only relevant if the Automatic return to RO mode parameter is defined as YES

COMMUNICATION

- **Controller Number:** Select the controller number for communication. The controller number in the controller and in the PC should match in order for the communication to work. Each controller in the network must have a unique number.
- **Lower Port – Protocol – Communicate with:**
 - ♦ NMC Net: Local Network
 - ♦ GSM RCLP – GSM Modem
- **Lower Port – Baudrate (PC Communication Network):** Select the lower port's baud rate for communication. The baud rate in the controller and in the PC must match; otherwise, the communication cannot operate properly.

 **Note:** See NMC-Pro Part 2 > Appendix 4 – Network connection & PC software for additional information regarding controller number and baud rate.

- **Upper Port – Protocol – SN/RF Net.** Square One Single Net protocol should be selected in order to define the Remote Unit Type.
- **Upper Port – Baudrate (Extension Box Network):** Select the upper port's baud rate for communication. The baud rate in the controller and in the extension boxes must match; otherwise, the communication cannot operate properly.

 **Note:** NMC-Pro Part 2 > Table 2 – Baud rate values. This table provides explanations regarding how to set the Baud rates in the extension boxes.

- **Remote unit type:** Select the type of remote units connected to the NMC-Pro:
 - ♦ **NONE:** No remote units are connected to the NMC-Pro.
 - ♦ **SN/RF Net:** SingleNet or RadioNet remote units are connected to the NMC-Pro.
 - ♦ **SA RADIO:** Radio remote units are connected to the NMC-Pro.

 **Note:** When choosing SingleNet or Radio relevant parameters will appear in the controller.

 **Note:** Only one type on remote units (SingleNet or Radio) can be connected to a specific controller.

- **Extension Box # Connected:** Specify whether the relevant extension box is connected or not. The NMC-Pro will “search” for the relevant extension box and will update the Hardware Check List and all other relevant settings accordingly. If the NMC-Pro doesn't recognize the extension box an alarm “Ext. Box # Com fail” will be generated, in case communication is reestablished the alarm will be automatically reset.

WATER SOURCE

- **Flow Rate – Start From:** Select whether the flow rate calculation in an irrigation will begin either with the value Zero (which means that the flow rate will increase according to pulses received), or a Nominal value calculated using all the active valves in the irrigation. The calculation method is important primarily for dosing and EC/pH control. When using a controller which operates with relatively slow pulses, it is recommended to choose the Nominal flow rate option due to inaccurate flow calculation in the first stage of the irrigation. When operating with slow pulses and starting with a Zero value, it will take a long time for the controller to reach its' actual flow rate value. When operating by fast pulses, choose either Zero or Nominal.
- **Calculated Flow Delay:** This parameter is relevant only when Nominal is being selected in the previous parameter. This parameter defines the time the controller uses its' nominal flow rate value before switching to the calculated one. In this period LOW FLOW and HIGH FLOW alarms will not be detected.

10.3 Temperature Calibration

This menu enables calibrating temperature sensors. Use the Left/right arrow keys to increase/decrease the values. Netafim recommends calibrating the temperature sensors using a reference sensor.

Sensor	Temp	Factor
1	22.8	0.0
2	N/A	---
3	N/A	---
4	N/A	---
5	N/A	---
6	N/A	---
7	N/A	---
8	N/A	---

Press <-> Arrows to Increase/Decrease

10.4 Humidity Calibration

This menu enables calibrating humidity sensors. Use the Left/right arrow keys to increase/decrease the values. Netafim recommends calibrating the humidity sensors using a reference sensor.

10.5 EC/pH Calibration

Calibration of EC & PH is comprised of two steps:

- Calibration of the EC/pH Monitor Transmitter, page 102
- EC/pH Transmitter Monitor & NMC-Pro Correlation, page 104

10.5.1 Calibration of the EC/pH Monitor Transmitter

Use the following instructions when using Netafim EC/pH transmitters. When using other types of transmitters use calibration guidelines supplied by the manufacturer and jump to EC/pH Transmitter Monitor & NMC-Pro Correlation.



EC & PH main screen

10.5.1.1 EC Calibration

- Auto Set EC (EC factory set)
- EC Soft Calibration

10.5.1.1.1 Auto Set EC (EC factory set)

The Auto set procedure initializes all the previous corrections and sets the calibration according to the factory settings.

Perform Auto set on the first run and when you replace an EC Electrode with a new one.

1. Press the MENU button and wait for the Service prompt to appear.
2. Press SELECT button several times until AUTOSSET EC prompt is displayed and then press ENTER. The message OK is displayed for a while and then the display reverts back to normal.

Note: Always perform EC Soft Calibration after the Auto set EC (EC factor set)

10.5.1.1.2 EC Soft Calibration

1. Press the MENU button and wait for the Service prompt to appear.
2. Press SELECT button several times until the CALIB(rate) EC prompt is displayed and then press ENTER.
3. Use the SELECT button to choose EC 1.4 or EC 5, according to your water value and the buffers you have, press ENTER to confirm.
4. Insert the probe into the appropriate buffer, wait for approximately 10 seconds, and press ENTER. You will be asked to wait for a few seconds, while the unit performs the value correction.
5. The Gain point is now set and EC 0.0 will be displayed. Hold the EC probe out in the open air and wipe it gently with a napkin or a tissue, then press ENTER.
6. If the calibration process is completed successfully, EC Calibration OK is displayed. If it fails, EC CALIBRATION FAIL is displayed, in this case refer to NMC-Junior Irrigation – Part 2 > EC/pH > Troubleshooting.

SETUP MENU

10.5.1.2 pH Calibration

- Auto Set pH (pH Factory set)
- pH Soft Calibration

10.5.1.2.1 Auto Set pH (pH Factory set)

The Auto set procedure initializes all the previous corrections and sets the calibration according to the factory settings. Perform Auto set on the first run and when you replace a pH electrode with a new one.

1. Press **MENU** and wait for the Service prompt to appear.
2. Press **SELECT** several times until AUTOSet pH is displayed and press **ENTER**. The message OK is displayed for a while and then the display reverts back to normal.

Note: Always perform **pH Soft Calibration** after the **Auto set pH** (pH factory set)

10.5.1.2.2 pH Soft Calibration

1. Remove the pH probe and clean it by directing a stream of water towards its membrane. Do not wipe or dry the membrane.
2. Press the *MENU* button and wait for the *Service* prompt to appear.
3. Press **SELECT** button several times until the CALIB(rate) pH prompt is displayed and then press **ENTER**.
4. When pH 7.0 is displayed, immerse the probe in the pH 7.0 buffer, wait for approximately 10 seconds and press **ENTER**. You will be asked to wait for a few seconds, while the unit performs the value correction. The Gain point is now set.
5. When pH 4.0 is displayed, immerse the probe in the pH 4.0 buffer, wait for approximately 30 seconds and press **ENTER**. You will be asked to wait for a few seconds, while the unit performs the value correction. The Offset point is now set.
6. If the calibration process is completed successfully, pH Calibration OK will be displayed. If it fails, LOQUID IS POOR is displayed, please refer to NMC-Junior Irrigation – Part 2 > EC/pH > Troubleshooting.

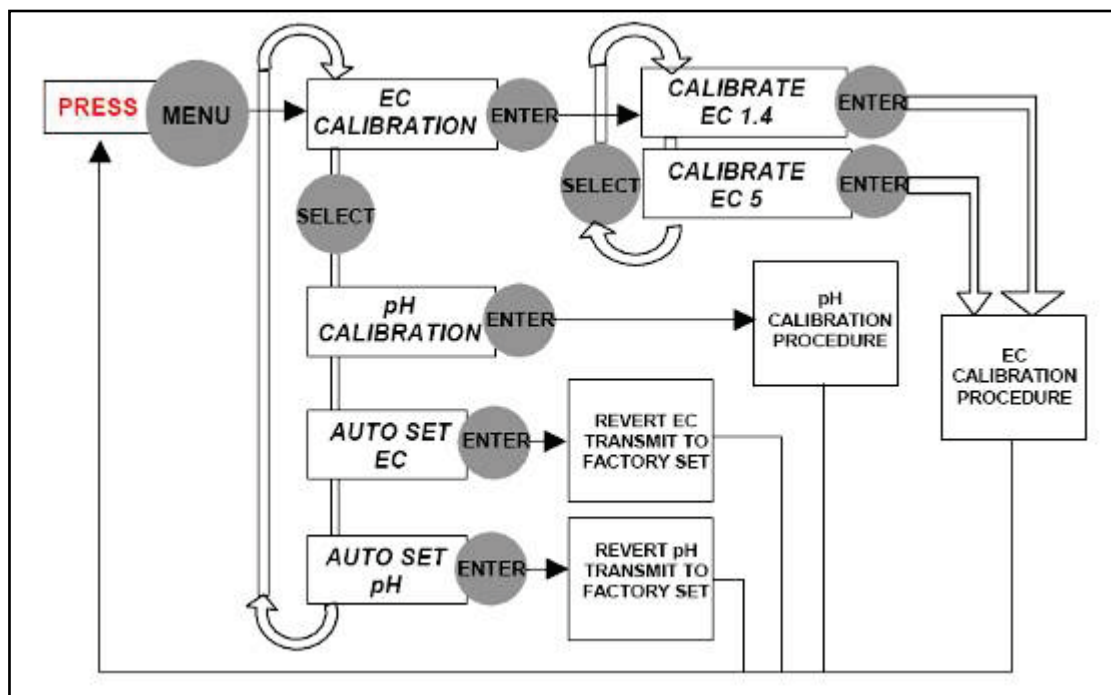

Menu Navigation Schema

SETUP MENU

10.5.2 EC/pH Transmitter Monitor & NMC-Pro Correlation

Sensor	Value	Factor
EC 1	1.71	0.06
PH 1	2.36	0.07
EC 2	<NONE>	---
PH 2	<NONE>	---
EC P	<NONE>	---

Press <-> Arrows to Increase/Decrease

Place the cursor on the relevant factor and use the left/right arrow keys to increase/decrease the factor until the values displayed by the NMC-Pro are equal to the values indicated on the EC/pH transmitter screen.

To ensure the measured values are stable it is recommended to immerse the sensor in calibration fluid when doing this process.

Under normal operation conditions the correlation process should be done only when there are system changes, for example when changing EC/pH sensors, nevertheless it is recommended to verify that the readings of the EC/pH transmitter and of the NMC-Pro are equal every time EC/pH calibration is performed, and adjust if required.

10.6 Pressure Calibration

This screen is used to calibrate inlet and outlet pressure sensors. Calibration of the pressure sensors is usually done using reference pressure sensors connected in the vicinity of the electronic pressure sensors.

Sensor	Value	Factor
Pressure In	3.15	-0.15
Pressure Out	1.31	1.31

Press <-> Arrows to Increase/Decrease

Use the left/right arrow keys to increase/decrease values until the values displayed by the NMC-Pro are equal to the values indicated on the reference pressure sensor.

10.7 Weather Station Calibration

Sensor	Value	Factor
Temperature	32.3	2.4
Humidity	45.3	1.4
Wind Direction	157	7
Radiation F.	912	0.78
Rad. Offset	912	17.00

Press <-> Arrows to Increase/Decrease
Enter S Speeds UP Radiation Factor

SETUP MENU

Use the left/right arrow keys to increase/decrease values.

- For temperature and humidity sensors calibration can be done using reference temperature and humidity sensors.
- Wind direction sensor should be calibrated so that the value indicated by the NMC-Pro fits the actual direction pointed by the wind direction sensor.
- The radiation sensor factor should be set as indicated in the calibration sticker supplied with the sensor. The radiation offset should be set to 17 unless specified otherwise.
See NMC-Pro Irrigation – Part 2 > Sensor specifications > Weather sensor specifications for additional information.

10.8 Sensors Logging

The Sensors Logging screen allows you to define which sensors should be logged.

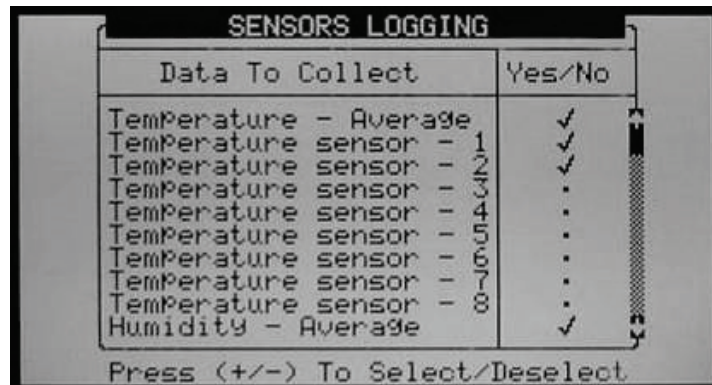

To select an item move the cursor using the arrow keys and mark it using the '+/-' key. Selected items are marked with ✓.

Note: When you change the sensors logging setup, the sensors history table resets and starts over; all sensors data accumulated on the controller is lost.

10.9 Write to Data Plug

Use a data-plug to save controller settings and restore them when needed. Plug the data-plug into the NMC-Pro data-plug socket (see **Figure 98**). The data-plug is symmetric so it can be plugged in both directions.

Enter the WRITE TO DATA PLUG screen and confirm your choice.

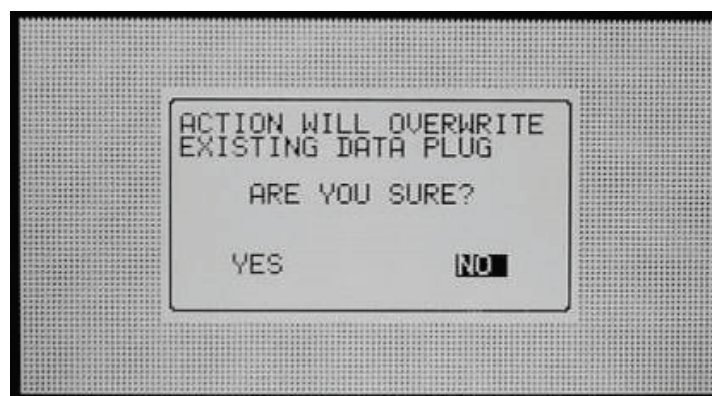

Note: When writing to a data-plug, old data on the data-plug will be overwritten.

10.10 Read from Data Plug

Use a data-plug to upload and restore controller settings when needed. Plug the data-plug into the NMC-PRO data-plug socket (see the figure below).

Data-plug

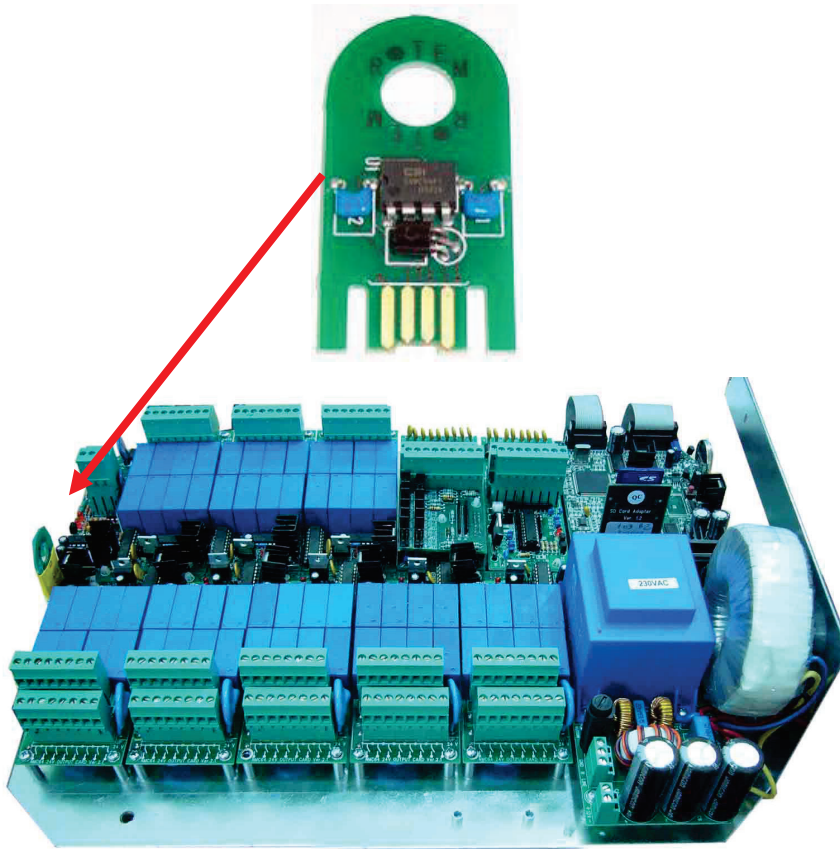

Note: The Data plug should be used when the system is idle; otherwise, some of the running programs might be interrupted and moved to halt.

Enter the **READ FROM DATA PLUG** screen and confirm your choice.



Note: When reading from the data-plug, the current settings data on the controller will be overwritten.

SETUP MENU

10.11 Edit SMS Phonebook

The *Edit SMS Phonebook* screen allows you to add and edit subscribers for the SMS service.

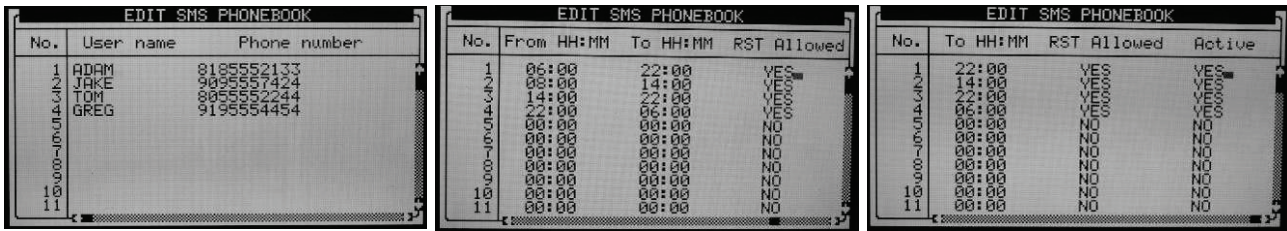

- **User name:** Enter the recipient name using the numeric keypad (can be up to 11 characters long)

1	2	3	4	5	6	7	8	9	0	.	+/-
' "	ABC	DEF	GHI	JKL	MNO	PQRS	TUV	WXYZ	SPACE ()	, ! ? \$	+ - < > #

- **Phone number:** Enter the recipient's phone number (can be up to 20 characters long)
- **From HH:MM / To HH:MM:** Schedule the time period for each subscriber, **From (time)**
/ To (time) in a 24 hour format (Example: 2:00pm = 14:00)
- **RST Allowed:** Define permission for the subscriber if to be allowed to reset the alarms
- **Active:** Define if the subscriber will receive SMS alarms

Note: Verify that the SMS Support ON is set to YES in order for the subscribers to receive their SMS (10.12 SMS Setup)

10.12 SMS Setup

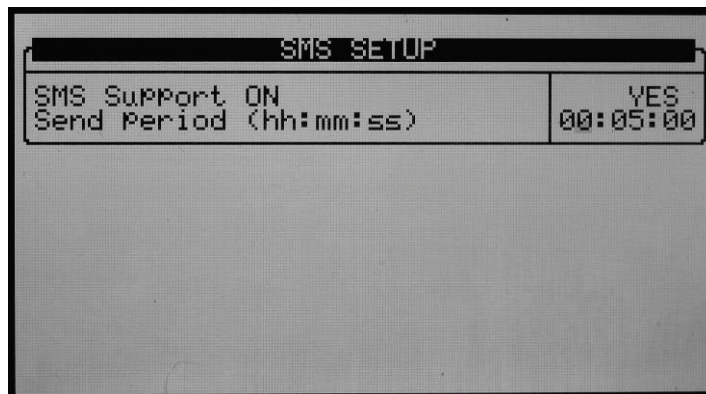

- **SMS Support ON:** Select **YES** in order to activate the SMS feature
- **Send Period (hh:mm:ss):** Define how often the controller will check for new alarms to send Default:
every 5 minutes **00:05:00**

SETUP MENU

10.13 SMS Personal Message

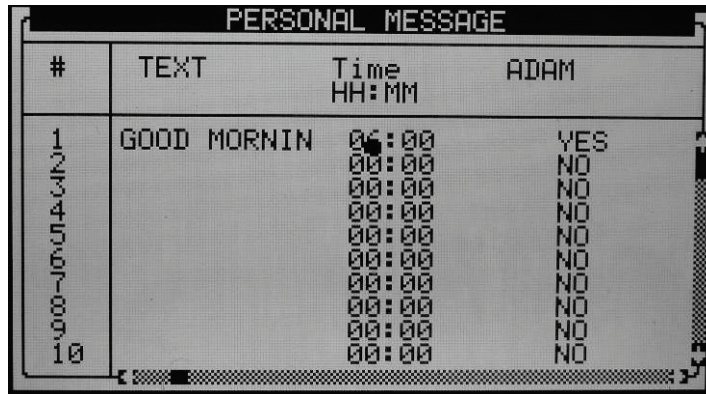

#	TEXT	Time HH:MM	ADAM
1	GOOD MORNIN	06:00	YES
2		00:00	NO
3		00:00	NO
4		00:00	NO
5		00:00	NO
6		00:00	NO
7		00:00	NO
8		00:00	NO
9		00:00	NO
10		00:00	NO

Define up to 12 personal messages to be sent out at a preset time to any of the subscribers. The personal message can be up to 70 characters long. For the text use the numeric keypad.

1	2	3	4	5	6	7	8	9	0	.	+/-
' "	ABC	DEF	GHI	JKL	MNO	PQRS	TUV	WXYZ	SPACE ()	.,!?\$	+ - < > #

11 CONFIGURATION MENU

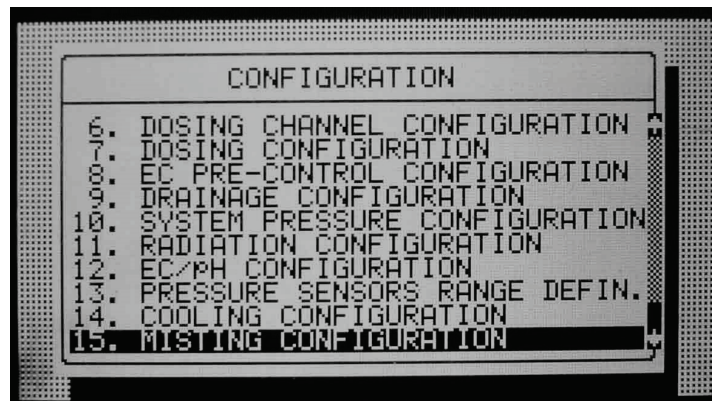
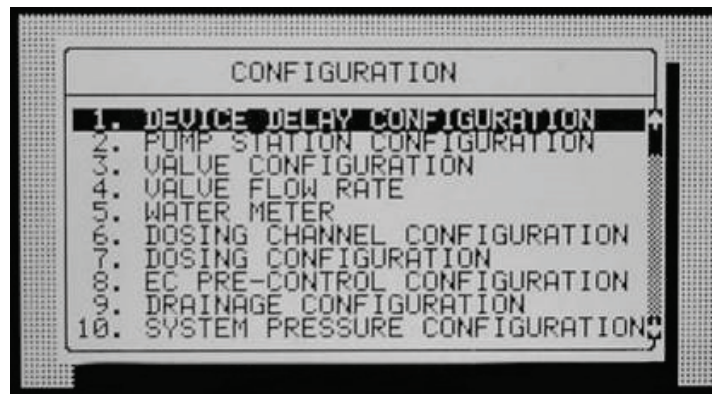

- Device Delay Configuration 110
- Valve Configuration, page 113
- Valve Flow Rate, page 114
- Water Meter, page 115
- Dosing Channel Configuration, page 116
- Dosing Configuration, page 119
- EC Pre-Control Configuration, page 120
- Drainage Configuration, page 120
- System Pressure Configuration, page 121
- EC/pH Range Definition, page 121
- Pressure Sensor Range Definition, page 121
- Cooling Configuration, page 122
- Misting Configuration, page 122

CONFIGURATION MENU

11.1 Device Delay Configuration

The Device Delay Configuration screen enables defining the startup and shutdown order of the irrigation process.

	On mm:ss	Off mm:ss
Pump	--:--	00:35
Main Valve	01:00	00:15
Valve	01:30	--:--

IN-PROGRAM DELAYS	
Shift delay (sec)	-30
Stagger delay (sec)	20

- On (mm:ss): On is the definition of the startup order. The set times are taken from procedure startup. The device with the shortest time will be started first and shifted to procedure startup. Therefore it is recommended that the device that is to be started first be set as 00:00 (automatically changes to --:--).
- Off (mm:ss): Off is the definition of the shutdown order of the irrigation process. The set times are taken from procedure shutdown. The device with the shortest time will be stopped first and shifted to procedure shutdown. Therefore it is recommended that the device that is to be stopped first be set as 00:00 (automatically changes to --:--).

11.1.1 Example of Device Startup & Shutdown Order

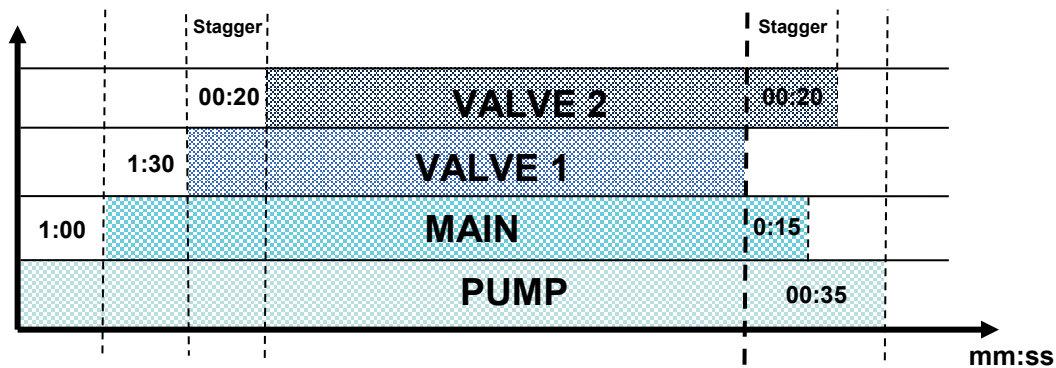

- **Startup:** According to the settings above, the pump will be turned on first (on procedure startup). The main valve will be opened after 1 minute and 30 seconds later (1:30 minutes from procedure startup) the valve.
- **Shutdown:** According to the settings above the valve will be turned off first (on procedure shutdown). The main valve will be closed after 15 seconds and the pump will be closed 20 seconds later (35 seconds from procedure shutdown).

Note: It is recommended that the device that should be started (stopped) first be defined as zero (will appear as --:--).

IN-PROGRAM DELAYS

- **Shift delay (sec):** Define the time (in seconds) between each valve change. The shift delay can also be a shift advance by inserting a negative value. This means that the next valve will start before the previous one.
- **Stagger delay (sec):** Define the time (in seconds) for the first shift and the last shift delay between valves (inside of group).

CONFIGURATION MENU

11.1.2 Example of Stagger Valve Delay – Multiple Shifts

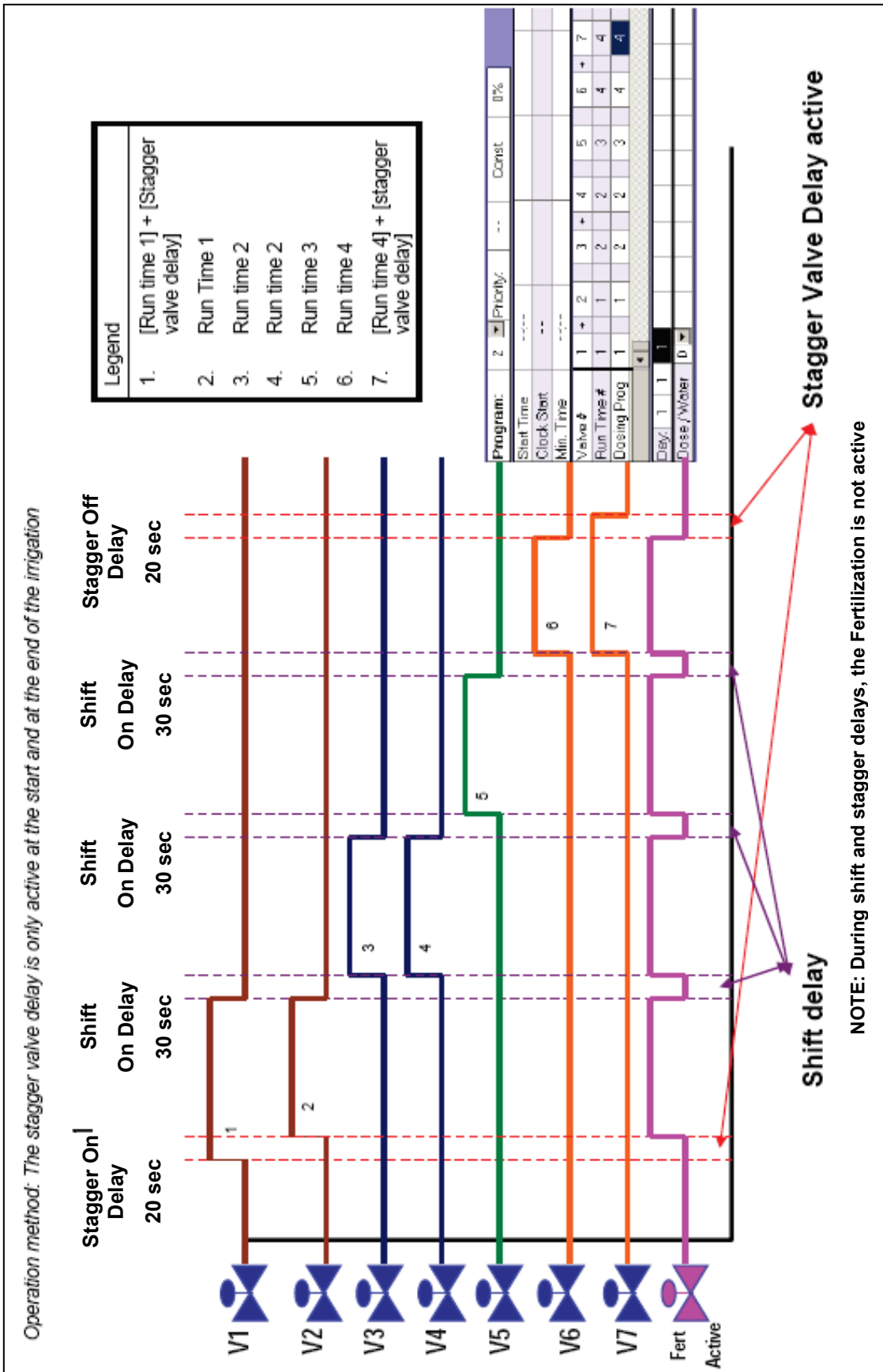

11.2 Pump Station Configuration

The NMC-Pro can include up to six pumps. Each valve (irrigation, cooling or misting) can be connected to one of the pumps or to the pump station. The pump station is a group of pumps (out of the six possible pumps) that will be started in accordance with the required flow.

The Pump Station configuration screen allows you to define which pumps are part of the station, the capacity of the various pumps and their startup and shutdown delays.

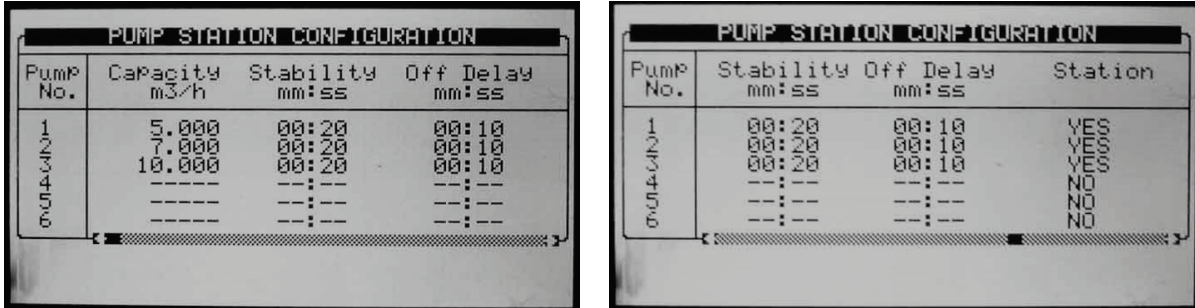

The NMC-Pro automatically calculates the expected flow and determines which pump (or pumps) should be started (see **Valve Configuration** for additional information regarding flow calculation). The NMC-Pro will start the minimal number of pumps required to supply the calculated flow rate.

If several pumps should be started, the NMC-Pro starts from the largest to the smallest and will turn them off from the smallest to the largest.

- **Pump No.:** Pump number.
- **Capacity:** Define pump capacity in m3 or gallon. This will be the maximum pump capacity, above which the NMC-Pro will turn on another pump (if available).
- **Stability (mm:ss):** Define stability time. Stability time is the startup time required for current pump before next pump can be started up. Stability time is usually used to prevent voltage drop down and water hammer (see [Pump Startup Order](#) schema).
- **Off Delay (mm:ss) :** Define off delay. Off delay will be the delay time for current pump to stop after last pump has stopped. This delay is usually used to prevent water hammer (see [Pump Shutdown Order](#) schema).
- **Station (Yes/No):** Define whether the pump is part of the pump station.

The following is a startup and shutdown order schema according to the settings above and a calculated flow rate of 60 m³/h:

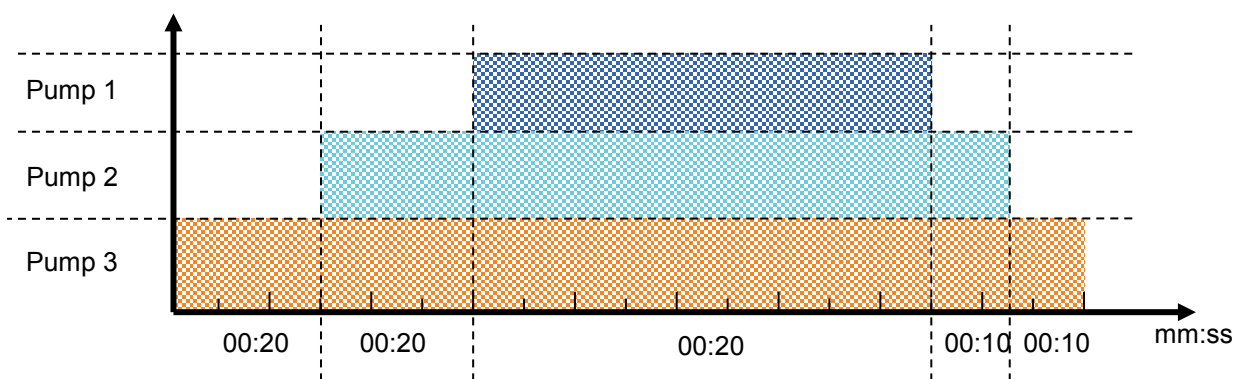

Pump startup & shutdown order

11.3 Valve Configuration

Valve configuration allows you to configure devices such as pumps, main valves and drainage measurement of valves.

VALUE CONFIGURATION				
Valve No.	Pump	Main Valve	Water Meter	Drain Meter
115	Pump 2	1	2	2
116	Station	1	1	1
117	Pump 3	1	3	3
118	Station	1	1	1
119	Pump 4	1	4	4
120	Station	1	1	1
121	Pump 2	1	2	1
122	Station	1	1	1
123	Station	1	1	1
124	Pump 4	1	1	1

VALUE CONFIGURATION				
Valve No.	Main Valve	Water Meter	Drain Meter	Drain Type
115	1	2	2	Sample
116	1	1	1	Total
117	1	3	3	Sample
118	1	1	1	Total
119	1	4	4	Sample
120	1	1	1	Total
121	1	2	1	Total
122	1	1	1	Total
123	1	1	1	Total
124	1	1	1	Total

VALUE CONFIGURATION				
Valve No.	Water Meter	Drain Meter	Drain Type	Sample %
115	2	2	Sample	50.0000%
116	1	1	Total	-----
117	3	3	Sample	80.0000%
118	1	1	Total	-----
119	4	4	Sample	100.0000%
120	1	1	Total	-----
121	2	1	Total	-----
122	1	1	Total	-----
123	1	1	Total	-----
124	1	1	Total	-----

- **Valve No.:** Indication of the valve number.
- **Pump:** Define which pump or pump station should be started when irrigating this valve. When choosing Station, the NMC-Pro will choose which and how many pumps should be started to supply the required (calculated) flow. See Pump Station Configuration on page 112 for more information).
- **Main Valve:** Define which main valve should be opened when starting each valve.
- **Water Meter:** Configure a water meter to each valve. This option is only possible when the flow calculation (water meter type) is Standard.

Note: Make sure that you define an operative water meter. There is no protection against defining a water meter that isn't properly defined in the system.

Note that when operating using Water Source (unlike Standard, in table 7.5) a valve is not configured to a specific water meter. In this case, all water meters set in the system are relevant for each irrigation and their pulses are calculated for the flow rate, hence, water meter column will be ignored in valve configuration table.

Note: Make sure that you define an operative water meter. There is no protection against defining a water meter that isn't properly defined in the system.

Note: When using more than one water meter it is recommended not to start to valves that are not configured to the same water meter simultaneously; the NMC-Pro uses only the water meter connected to the leading valve and does not sum the flow from the rest of the water meters, this might create unexpected alarms and malfunctions!

- **Drain Meter:** Define which drain meter this valve is connected to.
- **Drain Type:** Define drainage type:
 - ♦ **Total:** Drainage is collected from the complete valve area.
 - ♦ **Sample:** Drainage is collected from a representing part of the valve area.

Note that it is possible to set several valves to the same drain meter when working by 'Total'. The system does not allow operating several valves on the same meter when operating by 'Sample'.

- **Sample %:** When using sample drainage measurement it is required to define the ratio of the sample area to the complete valve area.

11.4 Valve Flow Rate

VALVE FLOW RATE			
Valve No.	Nominal m3/h	Minimum m3/h	Maximum m3/h
51	5.000	3.750	6.250
52	19.000	14.250	23.750
53	20.000	15.000	25.000
54	22.000	16.500	27.500
55	13.000	9.750	16.250
56	15.000	11.250	18.750
57	22.000	16.500	27.500
58	30.000	22.500	37.500
59	11.000	8.250	13.750
60	14.000	10.500	17.500

VALVE FLOW RATE			
Valve No.	Nominal m3/h	Minimum m3/h	Maximum m3/h
246	5.000	3.750	6.250
247	13.000	9.750	16.250
248	16.000	12.000	20.000
249	19.000	14.250	23.750
250	4.000	3.000	5.000
251	23.000	17.250	28.750
252	18.000	13.500	22.500
253	25.000	18.750	31.250
254	5.000	3.750	6.250
255	22.000	16.500	27.500

- **Nominal:** Define nominal valve flow rate (m3/h or gallon/min). The NMC-Pro uses the set nominal flow rate for calculating the ratio between valves when starting a few valves together, the boundaries for alarms, the total flow rate for calculating how many pumps to start, etc. Therefore it is recommended to try and set the nominal flow rate as close as possible to the actual flow rate.
- **Minimum:** Minimum valve flow rate, under which the system will generate a low flow alarm. When changing the Nominal flow rate this setting is automatically set to 25% under the nominal flow, and can be manually changed.
- **Maximum:** Maximum valve flow rate, above which the system will generate a high flow alarm. When changing the nominal flow rate this setting is automatically set to 25% above the nominal flow, and can be manually changed.

△ **Note:** When starting several valves simultaneously the system will sum their nominal, minimal and maximal flow rates. An alarm will be generated only if the measured flow rate is lower than the total minimum, or higher than the total maximum.

△ **Note:** When starting several valves simultaneously, the quantities between them will be divided based on the ratio of their nominal flow.

CONFIGURATION MENU

11.5 Water Meter

- **Ratio:** Set volume per pulse of each water meter or auxiliary meter.
- **Type:** Define type of flow calculation:
 - ♦ **Standard:** In this function valves which are operated in a group should be connected to the same water meter.

Note: If a few valves configured to different water meters will be started simultaneously, the NMC-Pro uses the flow measured by the water meter connected to the leading valve.

- ♦ **Water source:** The NMC-Pro will sum or deduct flow measured simultaneously from a few water meters. When choosing this function an additional column called "SUM" will appear, this column enables to define which water meters should be summed and which deducted from the total measured flow.

Note: Flow calculation type is a general definition for all water meters, therefore when changing type of water meter for one of the water meters the type will be changed for all water meters.

Note: When setting flow calculation (water meter type) to Water source it is not possible to configure valves to water meters.

- **Sum:** Define whether flow measured by each water meter should be added to the total measured flow or deducted:
 - ♦ "+" Flow measured by this water meter will be added to the total measured flow.
 - ♦ "-" Flow measured by this water meter will be deducted from the total measured flow.

Note: Since flow cannot be negative, if the controller measures negative flow it will show zero.

Note: If all valves are set to "-" the system will ignore the measured flow and will use the calculated flow (based on the nominal flow).

Description	Ratio	Type
Water Meter 1(L/P)	10.000	W. SOURCE
Water Meter 2(L/P)	20.000	W. SOURCE
Water Meter 3(L/P)	50.000	W. SOURCE
Water Meter 4(L/P)	100.000	W. SOURCE
Water Meter 5(L/P)	10.000	W. SOURCE
Water Meter 6(L/P)	-----	W. SOURCE
AUX Meter 1 (L/P)	-----	-----
AUX Meter 2 (L/P)	-----	-----
AUX Meter 3 (L/P)	-----	-----
AUX Meter 4 (L/P)	-----	-----
AUX Meter 5 (L/P)	-----	-----

Description	Type	Sum
Water Meter 1(L/P)	W. SOURCE	+
Water Meter 2(L/P)	W. SOURCE	+
Water Meter 3(L/P)	W. SOURCE	+
Water Meter 4(L/P)	-----	+
Water Meter 5(L/P)	STANDARD	-
Water Meter 6(L/P)	W. SOURCE	+
AUX Meter 1 (L/P)	-----	-----
AUX Meter 2 (L/P)	-----	-----
AUX Meter 3 (L/P)	-----	-----
AUX Meter 4 (L/P)	-----	-----
AUX Meter 5 (L/P)	-----	-----

Description	Ratio	Type
Water Meter 1(L/P)	10.000	STANDARD
Water Meter 2(L/P)	20.000	STANDARD
Water Meter 3(L/P)	50.000	STANDARD
Water Meter 4(L/P)	100.000	STANDARD
Water Meter 5(L/P)	10.000	STANDARD
Water Meter 6(L/P)	-----	STANDARD
AUX Meter 1 (L/P)	-----	-----
AUX Meter 2 (L/P)	-----	-----
AUX Meter 3 (L/P)	-----	-----
AUX Meter 4 (L/P)	-----	-----
AUX Meter 5 (L/P)	-----	-----

Note: It is very important to choose the correct flow meter for the application. Choosing a wrong flow meter might result in measurement errors or an inaccurate control. For instructions regarding how to choose the correct water meter see NMC-Pro Irrigation > General > Flow meter determination.

11.6 Dosing Channel Configuration

DOSING CHANNEL CONFIGURATION			
No.	Pump	Method	Ratio
1	Analog	Time (Lit/h)	300.000
2	Analog	Time (Lit/h)	300.000
3	Venturi	Time (Lit/h)	150.000
4	Venturi	Time (Lit/h)	200.000
5	Analog	Time (Lit/h)	150.000
6	Venturi	Time (Lit/h)	150.000
7	Venturi	Time (Lit/h)	150.000
8	Venturi	Time (Lit/h)	150.000

DOSING CHANNEL CONFIGURATION			
No.	Ratio	React	High (%)
1	300.000	EC	50
2	300.000	EC	50
3	150.000	pH	50
4	200.000	pH	50
5	150.000	EC	50
6	150.000	EC	50
7	150.000	pH	50
8	150.000	pH	50

DOSING CHANNEL CONFIGURATION			
No.	High (%)	Low(%)	V/P(L)
1	50	20	0.100
2	50	20	0.100
3	50	20	0.100
4	50	20	0.100
5	50	20	-----
6	50	20	-----
7	50	20	-----
8	50	20	-----

- **Pump:** Select the type of dosing pump:
 - ♦ **Venturi:** The dosing unit consists of Venturi driven injectors. The dosing booster will be turned on when fertigation is active (refer to the following section Analog Output Card Calibration with Dosing Machine).
 - ♦ **Hydraulic:** The dosing unit consists of hydraulic fertilizer pumps. The dosing booster is not needed and will not be turned on when Fertigation is active. When working with hydraulic pump, the method can only be Liter/Pulse and EC & pH control is not possible.
 - ♦ **Electric:** The dosing unit consists of electrical fertilizer pumps. The dosing booster is not needed and will not be turned on when Fertigation is active.
 - ♦ **Analog:** This dosing unit consists of pumps controlled by 4 – 20 mA analog output. Define the analog outputs in Analog Output Definition, page 42.
- **Method:** Select the operating method:
 - ♦ **Liter/Pulse:** Define whether a dosing meter is connected to this channel and used for control purposes. Set the volume per pulse on the Ratio column.
 - ♦ **Time (cc/sec):** Define whether the calculated flow rate of the dosing channel is in CC (gallons) of fertilizer per second.
 - ♦ **Time (Liter/min):** Define whether the calculated flow rate of the dosing channel is in liters (gallons) per minute.
 - ♦ **Time (Liter/Hour):** Define whether the calculated flow rate of the dosing channel is in liters (gallons) per Hour (default option).
- **Ratio**
 - ♦ Method is Time: Define calculated flow rate, this will be the flow rate of the channel when completely open.
 - ♦ Method is Liter/Pulse: Define the volume per pulse.
- **React:** Set the required use of the channel:
 - ♦ **EC:** The channel is used to increase measured EC, meaning it will be opened more when the measured EC is lower than the set EC.
 - ♦ **pH:** The channel is used to decrease measured pH, meaning it will be opened more when the measured pH is higher than the set pH.

CONFIGURATION MENU

- ♦ **Passive:** The channel does not respond to changes in measured EC/pH, meaning it will be opened as set in the dosing program regardless of the EC/pH values.
- ♦ **Alkali:** The channel is used to increase measured pH, meaning it will be opened more when the measured pH is lower than the set pH.

△ **Note:** If EC/pH control is off, or the channel is used for proportional injection only (for example in order to inject chemicals) set reaction to passive.

- **High %:** set an injection percentage limit. This percentage will limit the deviation from set dosing recipe when NMC-Pro is injecting more than specified in order to try and reach the target EC/pH values.
- **Low %:** set an injection percentage limit. This percentage will limit the deviation from set dosing recipe when NMC-Pro is injecting less than defined in order to try and reach the target EC/pH values.
- **V/P(L/G):** This parameter will be disabled when operating by Liter/Pulse. Define the volume per pulse of the dosing meter (liters or gallons). Only required when using a dosing meter for measurement and alarm purposes. When using a dosing meter for control purposes the volume per pulse of the dosing meter should be defined on the Ratio column. The letter between the brackets indicates whether the volume units are in Liter or Gallon.

11.6.1 Calibrating the Analog Dosing Valve

The following section details how to calibrate the dosing valve when using Venturi Pumps.

1. Ensure that all dosing channels are physically connected to the fertilizer tanks.

△ For purposes of calibrating the dosing, the tanks can be filled with water.

2. Verify that the needle valve is completely open (100%).
3. Go to Testing > Relays.
4. Manually operate the Irrigation Program and Dosing Booster.
5. Go to Test > Analog Output.
 - a. Set the status as Manual.
 - b. Define all openings as 25%.
 - c. Check the injection rate/fertilizing rate on the Rotameter.



Example: If the observed rate is 100 liters per hour when set at 25%, the maximum rate should be 400 liters per hour (formula: $100 / 0.25 = 400$).

△ Even when the Venturi capacities are the same, and the opening percentage is the same for each valve, there can be small variations in the actual flow rate.

△ Be aware that when you use water to calibrate the Rotameter valves, there can be different reading when fertilizer is actually used.

CONFIGURATION MENU

6. Go to Configuration > Dosing Channel Configuration.

7. Under Ratio, enter the calculated injection rate/fertilizing rate. In the following screen, these numbers would be changed to 400 (the result of the equation shown in step 5c).

No.	Pump	Method	Ratio
1	Analog	Time(Lit/h)	460.000
2	Analog	Time(Lit/h)	480.000
3	Analog	Time(Lit/h)	456.000
4	Analog	Time(Lit/h)	420.000

8. To fine tune the ratio:

- Prepare an Irrigation Program using the most common dosing capacity program.
- Run the program.
- Check the actual flow on the Rotameter.
- Adjust all Rotameters to the same flow by adjusting the Ratio settings as needed.

△ Decreasing the flow in the controller settings increases the actual flow seen in the Rotameter.

△ The goal of this process is to equate (to the greatest extent possible) the Rotameter's actual flow rate to the flow rate shown in HotKey 4.

Chan.	1	2	3	4	5
Open %	64	64	64	18	---
Min %	31	31	31	9	---
Prg %	62	62	62	18	---
Max %	93	93	93	27	---
Flow	258	258	258	74	---

11.7 Dosing Configuration

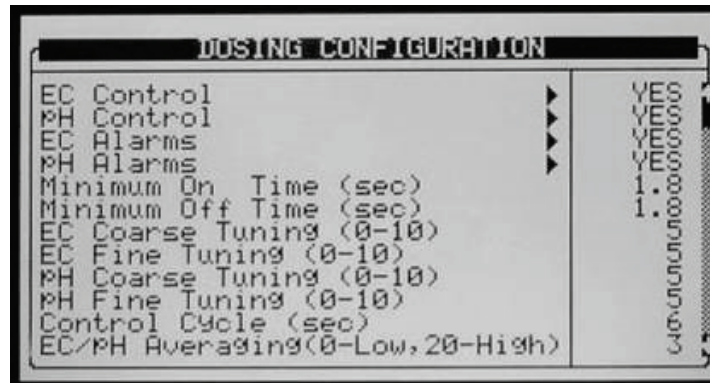

- **EC Control:** Define whether EC control should be operative.
- **pH Control:** Define whether pH control should be operative.
- **EC Alarms:** Define whether EC related alarms are operative. When EC control is set to 'Yes', EC Alarms are automatically set to 'Yes' and cannot be changed.
- **pH Alarms:** Define whether pH related alarms are operative. When pH control is set to 'Yes' pH Alarms are automatically set to 'Yes' and cannot be changed.
- **Minimum On Time (sec):** Define the minimum time the dosing regulator may be opened for. This feature is used to protect the regulator from being excessively turned on and off. The minimum allowed on time is 0.4 seconds.
- **Minimum Off Time:** Define the minimum time the dosing regulator may be turned off. This feature is used to protect the regulator from being excessively turned on and off. The minimum On time allowed is 0.4 seconds.
- **EC Coarse Tuning (0-10):** EC Coarse Tuning is used to adjust the speed and strength of the EC control. A higher value will result in faster correction but might lead to over shooting (see Appendix 1 – General > EC/pH correction adjustment for further information).
- **EC Fine Tuning (0-10):** EC Fine Tuning is used to fine tune the EC control shooting (see NMC-Pro Irrigation > Part 2 > General > EC/pH correction adjustment for further information).
- **pH Coarse Tuning (0-10):** pH Coarse Tuning is used to adjust the speed and strength of pH control. A higher value will result in faster correction but might lead to over shooting (see NMC-Pro Irrigation > Part 2 > General > EC/pH correction adjustment for further information).
- **pH Fine Tuning (0-10):** pH Fine Tuning is used to fine tune pH control shooting (see NMC-Pro Irrigation > Part 2 > General > EC/pH correction adjustment for further information).
- **EC Control Cycle (sec):** Define the control cycle for EC control. This should be the time it takes the system since it injected fertilizer/acid until the change in recognized by the system.
- **pH Control Cycle (sec):** Define the control cycle for pH control. This should be the time it takes the system since it injected fertilizer/acid until the change in recognized by the system.
- **EC/pH Averaging (0-Low, 20-High):** Averaging factor for EC/pH measurement. EC/pH averaging should be used to enable correction when injection is not homogenous.
- **Dosing Booster Off Delay (mm:ss):** Define the time that the dosing booster should be left on after dosing has ended. This time is usually used to circulate the acid and nutrients in order to prevent high concentrations in the area of the venturies and dosing booster when the system is idle.
- **Dosing by QTY. Method:**
 - ♦ **Bulk:** All channels set to QTY (quantity) dosing method will inject the set quantity in one bulk, starting after water before quantity/time has elapsed.
 - ♦ **Spread Out:** The set dosing quantity of all channels set to QTY (quantity) dosing method will be spread throughout the irrigation.

11.8 EC Pre-Control Configuration

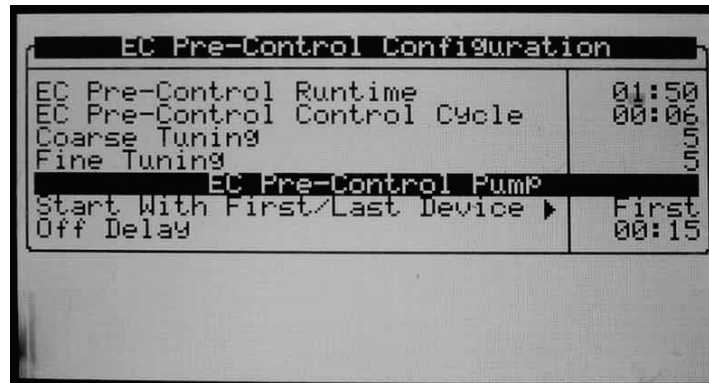

- **EC Pre-Control Configuration:**
 - ♦ **EC Pre-Control Runtime:** Set the time it takes the EC Pre-Control valve to shift from fully closed to fully open. This parameter is very important and must be exact as the controller uses this parameter to calculate the opening percentage of the EC Pre-Control valve.
 - ♦ **EC Pre-Control Control Cycle:** Set the time it takes since the EC Pre-Control valve changes position until the change is measured by the EC Pre-Control sensor.
 - ♦ **Coarse Tuning:** Coarse Tuning is used to adjust control speed and strength. A higher value will result in faster correction but might lead to over-closing, a lower value might result in slow reaction.
 - ♦ **Fine Tuning:** Fine Tuning is used to fine tune EC Pre-Control behavior.
- **EC Pre-Control Pump:**
 - ♦ **Start With First/Last Device:** Define whether the EC Pre-Control Pump should open with the first or the last device of the irrigation (refer to table 1.3 to see device startup order).
 - ♦ **Off Delay:** Define Off delay (if required) for the EC Pre-Control pump.

11.9 Drainage Configuration

DRAINAGE CONFIGURATION			
Meter No.	Ratio Liter/Pulse	On Delay	Off Delay
1	1.000	00:01:00	00:03:00
2	1.000	00:06:00	00:05:00
3	1.000	00:10:00	00:10:00
4	----	--:--:--	--:--:--
5	----	--:--:--	--:--:--
6	----	--:--:--	--:--:--
7	----	--:--:--	--:--:--
8	----	--:--:--	--:--:--

- **Ratio:** Define volume per pulse of the drainage meters (liter/pulse or gallon/pulse).
- **On Delay:** Define how long a valve, which is configured to this drainage measurement, should be open before the measured drainage is related to this valve. All drainage measured before this time has elapsed (although the valve is open) will still be related to the previous opened valve that was configured to this drainage sump.
- **Off Delay:** Define how long after irrigation has finished, the measured drainage should still be related to the previous irrigation. This value is used to “tell” the NMC when to stop relating drainage to the previous irrigation and write it to all relevant history tables.

CONFIGURATION MENU

11.10 System Pressure Configuration

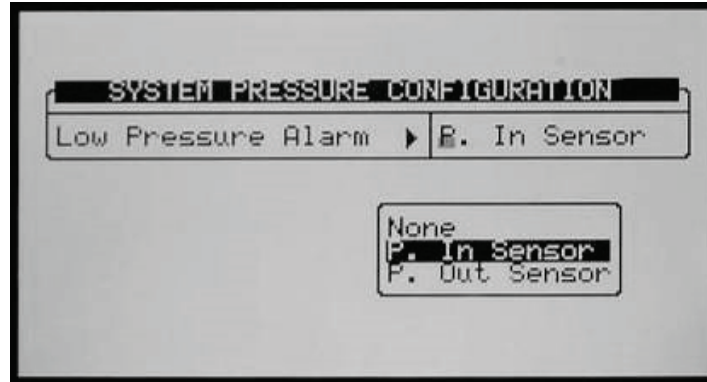

Define which pressure sensor (inlet or outlet) should be used as the system's pressure. This sensor can later be defined to stop the system in case of low pressure (see table 1.7).

11.11 EC/pH Range Definition

Sensor	4 mA	20 mA	Sensor Dif.
EC 1	0	10	
PH 1	0	14	
EC 2	0	10	----
PH 2	0	14	----
EC P	0	20	

EC Control Sensor ▶ EC 1+EC 2

PH Control Sensor ▶ PH 1+PH 2

Define the range of the EC/pH transmitters.

- Default settings for Netafim EC/pH transmitters is:
 - ♦ EC: zero to 10 mS
 - ♦ PH: zero to 14 ppm
- EC Control Sensor: Define which EC sensor should be used for control. When setting EC 1 + EC 2, EC1 will be used for control, and EC2 will be used for verification.
- pH Control Sensor: Define which pH sensor should be used for control. When setting pH 1 + pH 2, pH1 will be used for control, and pH2 will be used for verification.

11.12 Pressure Sensor Range Definition

Sensor ▶	0 Volt	5 Volt
Pin (bar)	0.00	10.00
Pout (bar)	0.00	10.00

0 Volt
4 mA

- **0 – 5 Volt or 4 – 20 mA:** Use the arrow keys to move the cursor to the 0 Volt (4 mA), press ENTER to switch between 0 – 5 Volt and 4 – 20 mA.

CONFIGURATION MENU

- **0 Volt (4 mA):** Define the pressure (bar or PSI) that should be presented when 0 volts (4 mA) is read by the NMC-Pro.
- **5 Volt (20 mA):** Define the pressure (bar or PSI) that should be presented when 5 Volts (20 mA) is read by the NMC-Pro.

The NMC-Pro will create a linear graph between the 0 Volt (4 mA) to the 5 Volt (20 mA).

11.13 Cooling Configuration

The cooling configuration screen will only be visible after one (or more) cooling valves have been defined in the [DEVICE LAYOUT](#) table.

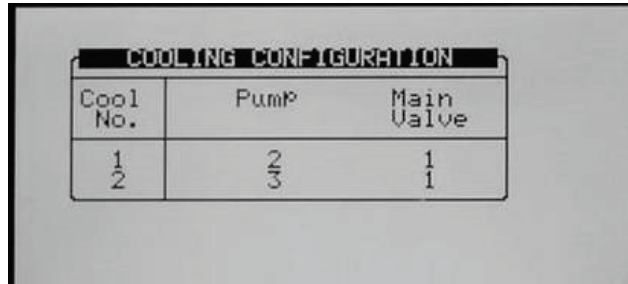

Cool No.	Pump	Main Valve
1 2	2 3	1 1

- **Pump:** Configure a pump to each cooling valve. This setting is not necessary if the cooling pump is not controlled by the NMC-Pro.
- **Main Valve:** Configure a main valve to each cooling valve. This setting is not necessary if the cooling doesn't have a main valve.

11.14 Misting Configuration

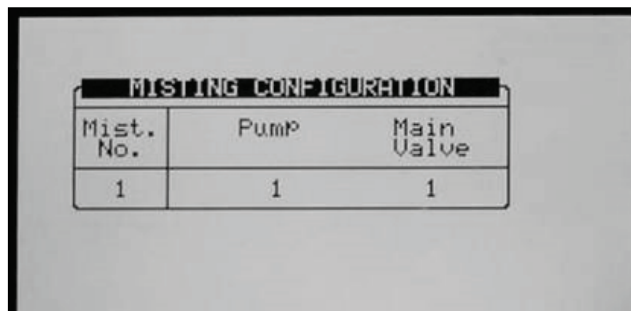

Mist. No.	Pump	Main Valve
1	1	1

- **Pump:** Configure a pump for each misting valve. This setting is not necessary if the misting pump is not controlled by the NMC-Pro.
- **Main Valve:** Configure a main valve to each misting valve. This setting is not necessary if the misting doesn't have a main valve.

12 INSTALLATION MENU

INSTALLATION	
1	DEVICE LAYOUT
2	DEVICE LIST
3	DIGITAL INPUT
4	ANALOG INPUT 1
5	ANALOG INPUT 2
6	ANALOG OUTPUT
7	HARDWARE CHECKLIST

- Device Layout, page 123
- Device List, page 125
- Digital Input, page 125
- Analog Input 1-2, page 126
- Analog Output, page 129
- Hardware Checklist, page 129

12.1 Device Layout

The device layout screen allows you to assign functions to each output (relay).

1. Place the cursor on the Function column, use the arrow keys to reach the relevant line, and press **ENTER**. A selection list including all available devices will appear.
2. Choose the required device and confirm by pressing **ENTER**. The cursor will move to the No. column.
3. Specify the number of the device in the controller and press **ENTER** to confirm.
4. If you wish to define several devices of the same type, for example valves 1 to 10, configure the first one and press **ENTER** a few times until you reach the required amount. The NMC-Pro automatically continues with the same device until instructed otherwise, or until reaching the system limitation for that device.
 - **Relay:** This column is divided to two sub-columns indicating relay number and the location of the relay card;
 - ♦ **Local:** Numbers 1 to 64 and the card exists.
 - ♦ **EXT 1:** Numbers 65 to 128 and the card exists.
 - ♦ **EXT 2:** Numbers 129 to 196 and the card exists.
 - ♦ **EXT 3:** Numbers 197 to 256 and the card exists.

△ **Note:** If the card does not exist, the column can show either 'N/A' (see **Screen 4** on next page) or 'R.U.' (see **Screen 5** on next page), according to parameter "Remote Unit Type" in table 6.2.

△ **Note:** If a selected value is different than 'None' in table 6.2, 'R.U.' is displayed in this table (see **Screen 5** on next page).

△ **Note:** If 'SingleNet' is chosen in table 6.2, the screen consists of 256 outputs.

△ **Note:** If 'Radio' is selected in table 6.2, the screen contains at least 64 outputs.

INSTALLATION MENU

Screen 1

DEVICE LAYOUT			
Relay		Function	No.
LOCAL	1	Dosing Channel	1
LOCAL	2	Dosing Channel	2
LOCAL	3	Dosing Channel	3
LOCAL	4	Dosing Channel	4
LOCAL	5	Dosing Channel	5
LOCAL	6	Dosing Channel	6
LOCAL	7	Dosing Channel	7
LOCAL	8	Dosing Channel	8
LOCAL	9	Dosing Channel	9
LOCAL	10	Dosing Booster	10
LOCAL		Pump	11

Screen 2

DEVICE LAYOUT			
Relay		Function	No.
LOCAL	62	Same As Relay	11
LOCAL	63	Same As Relay	12
LOCAL	64	Same As Relay	13
EXT1	65	Valve	51
EXT1	66	Valve	52
EXT1	67	Valve	53
EXT1	68	None	---
EXT1	69	None	---
EXT1	70	None	---
EXT1	71	None	---

Screen 3

DEVICE LAYOUT			
Relay		Function	No.
EXT1	125	None	---
EXT1	126	None	---
EXT1	127	Same As Relay	11
EXT1	128	Valve	54
EXT2	129	Valve	115
EXT2	130	Valve	116
EXT2	131	Valve	117
EXT2	132	None	---
EXT2	133	None	---
EXT2	134	None	---

Screen 4

DEVICE LAYOUT			
Relay		Function	No.
N/A	247	None	---
N/A	248	None	---
EXT3	249	None	---
EXT3	250	None	---
EXT3	251	None	---
EXT3	252	None	---
EXT3	253	None	---
EXT3	254	None	---
EXT3	255	Same As Relay	13
EXT3	256	Valve	255

Screen 5

DEVICE LAYOUT			
Relay		Function	No.
EXT1	76	None	---
EXT1	77	None	---
EXT1	78	None	---
EXT1	79	None	---
EXT1	80	None	---
EXT1	81	None	---
EXT1	82	None	---
EXT1	83	None	---
EXT1	84	None	---
EXT1	85	None	---

Note: After making changes, be sure to exit and return again to check for errors. The NMC-Pro will delete and replace conflicting assignments with '---'.

INSTALLATION MENU

12.2 Device List

The Device List screen allows you to view what type, and how many devices are currently defined. This screen automatically updates depending on the devices set in the 7.1 screen.

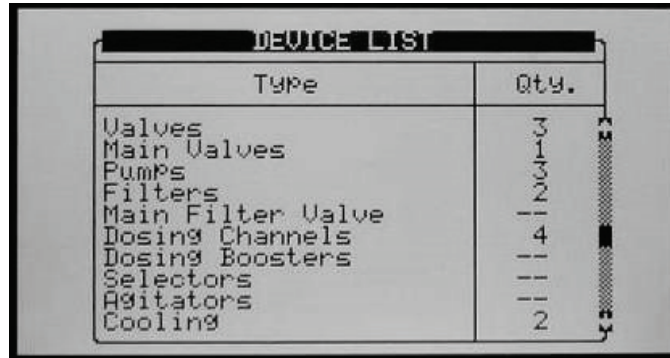

TYPE	Qty.
Valves	3
Main Valves	1
Pumps	2
Filters	2
Main Filter Valve	1
Dosing Channels	4
Dosing Boosters	1
Selectors	1
Agitators	1
Cooling	2

12.3 Digital Input

Place the cursor on the relevant line and press ENTER. A selection list will open. Choose the required sensor and press ENTER to confirm.

Inputs 1-32 are according to the following:

- Card no. 1: inputs 1 – 8
- Card no. 2: inputs 9 – 16
- Card no. 3: inputs 17 – 24
- Card no. 4: inputs 25 - 32

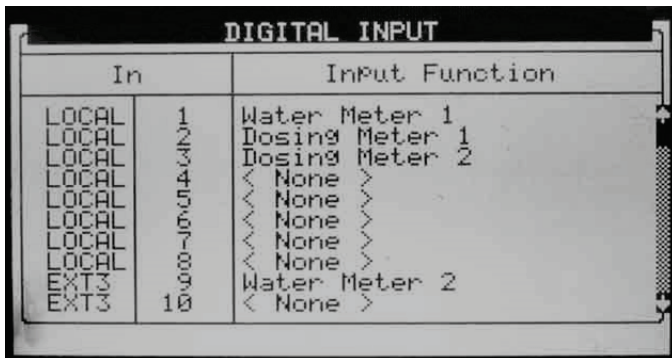

In	Input Function
LOCAL 1	Water Meter 1
LOCAL 2	Dosing Meter 1
LOCAL 4	Dosing Meter 2
LOCAL 5	< None >
LOCAL 6	< None >
LOCAL 7	< None >
LOCAL 8	< None >
EXT3 9	Water Meter 2
EXT3 10	< None >

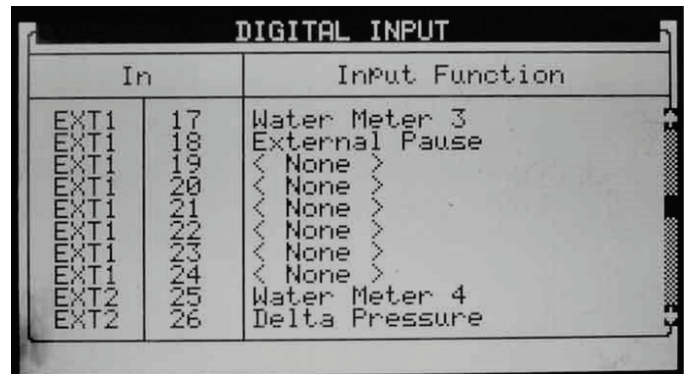

In	Input Function
EXT1 17	Water Meter 3
EXT1 18	External Pause
EXT1 19	< None >
EXT1 20	< None >
EXT1 21	< None >
EXT1 22	< None >
EXT1 23	< None >
EXT1 24	< None >
EXT2 25	Water Meter 4
EXT2 26	Delta Pressure

Note: If the cards do not exist, either 'N/A' or 'R.U' will be displayed, according to parameter "Remote Unit Type" in table 6.2.

Note: This table refers to both local and extension boxes.

Note: The card number is set according to its jumpers regardless to its location (local or extension box).

INSTALLATION MENU

12.4 Analog Input 1-2

1. In *Installation > Analog Input 1*, define input function(s) as Analog Sensors.

ANALOG INPUT No. 1			
Channel		Input Function	No.
LOCAL	1	<None>	-
LOCAL	2	<None>	-
LOCAL	3	<None>	-
LOCAL	4	<None>	-
LOCAL	5	<None>	-
LOCAL	6	<None>	-
LOCAL	7	<None>	-
LOCAL	8	<None>	-
LOCAL	9	<None>	-

ANALOG INPUT No. 1			
Channel		Input Function	No.
LOCAL	1	<Non	
LOCAL	2	<Non	08. Out Temp.
LOCAL	3	<Non	09. Out Humidity
LOCAL	4	<Non	10. Radiation
LOCAL	5	<Non	11. Wind Direction
LOCAL	6	<Non	12. Pressure In
LOCAL	7	<Non	13. Pressure Out
LOCAL	8	<Non	14. Rain Sensor
LOCAL	9	<Non	15. EC Drain Sensor
LOCAL	10	<Non	16. Analog Sensor

2. If required, in *Installation > Analog Input 1*, define the Expansion Channels.

ANALOG INPUT No. 1			
Channel		Input Function	No.
EXP1	12	EC Sensor	1
EXP1	13	pH Sensor	1
EXP1	14	Temp. Sensor	2
EXP1	15	Radiation	3
EXP1	16	<None>	-
EXP1	17	<None>	-
EXP1	18	<None>	-
EXP1	19	<None>	-
EXP1	20	<None>	-

3. In *Installation > Analog Input 2*, define input function(s) as Analog Sensors.

ANALOG INPUT No. 2			
Channel		Input Function	No.
LOCAL	1	<None>	-
LOCAL	2	<None>	-
LOCAL	3	<None>	-
LOCAL	4	<None>	-
LOCAL	5	<None>	-
LOCAL	6	<None>	-
LOCAL	7	<None>	-
LOCAL	8	<None>	-
LOCAL	9	<None>	-

ANALOG INPUT No. 2			
Channel		Input Function	No.
LOCAL	1	<Non	
LOCAL	2	<Non	08. Out Temp.
LOCAL	3	<Non	09. Out Humidity
LOCAL	4	<Non	10. Radiation
LOCAL	5	<Non	11. Wind Direction
LOCAL	6	<Non	12. Pressure In
LOCAL	7	<Non	13. Pressure Out
LOCAL	8	<Non	14. Rain Sensor
LOCAL	9	<Non	15. EC Drain Sensor
LOCAL	10	<Non	16. Analog Sensor

4. If required, in *Installation > Analog Input 2*, define the Expansion Channels.

 **Note:** Define up to 88 sensors.

INSTALLATION MENU

ANALOG INPUT No. 2			
Channel		Input Function	No.
EXP1	12	EC Sensor	1
EXP1	13	pH Sensor	1
EXP1	14	Temp. Sensor	2
EXP1	15	Radiation	3
EXP1	16	<None>	-
EXP1	17	<None>	-
EXP1	18	<None>	-
EXP1	19	<None>	-
EXP1	20	<None>	-

5. In *Setup > Analog Conversion Table*:

- Select the sensor type.
- Enter the required value in the minimum value column.
- Enter 100 in the maximum value column.

ANALOG CONVERSION TABLE			
Num.	Sensor Type	Min Value	Max Value
1	←->	←->	←->
2	←->	←->	←->
3	←->	←->	←->
4	←->	←->	←->

ANALOG CONVERSION TABLE			
Num.	Sensor Type	Min Value	Max Value
1		5	100
2	<NONE>	5	100
3	ECh20	10	100
4	Netasense	6	100
	Gen. Sensor Temperature		

6. In *Test > Analog Sensor*, view the actual sensor values.

ANALOG SENSOR		
No.	Type	Value
1	Netasense	36
2	Netasense	36
3	Netasense	36
4	Gen. Sensor	24
5	Gen. Sensor	24
6	ECh20	7
7	ECh20	7
8	ECh20	7
9	Temperature	21
10	Temperature	21

INSTALLATION MENU

7. In *Program > Ext Condition*, configure the External Condition Program for the analog sensors.

a. Enter the beginning and ending time for each program.

EXTERNAL CONDITION PROGRAM			
#	From hh:mm	To hh:mm	Start An. Dry Cont.
1	10:00	12:00	Ana. Sen 1
2	11:00	12:00	Dry Con 1
3	12:00	13:00	Dry Con 1
4	--:--	--:--	<NONE>
5	--:--	--:--	<NONE>
6	--:--	--:--	<NONE>
7	--:--	--:--	<NONE>
8	--:--	--:--	<NONE>

b. Under Start An. Dry Cont., define the input type.

EXTERNAL CONDITION PROGRAM			
#	From hh:mm	To hh:mm	Start An. Dry Cont.
1		12:00	Ana. Sen 1
2	Ana. Sen 1	12:00	Dry Con 1
3	Ana. Sen 2	13:00	Dry Con 1
4	Ana. Sen 3	--:--	<NONE>
5	Ana. Sen 4	--:--	<NONE>
6	Ana. Sen 5	--:--	<NONE>
7	Ana. Sen 6	--:--	<NONE>
8		--:--	<NONE>

c. Define The Trigger Type

EXTERNAL CONDITION PROGRAM			
#	Trigger Type	Stop An. Dry Cont.	Oper. to Start
1	Multi Shot	Ana. Sen 2	---
2	Multi Shot	Dry Con 2	One Shot
3	One Shot	Dry Con 14	Multi Shot
4	One Shot	<NONE>	Only If On
5	One Shot	<NONE>	---
6	One Shot	<NONE>	---
7	One Shot	<NONE>	---
8	One Shot	<NONE>	---

d. Under Stop An. Dry Con., define the input type.

EXTERNAL CONDITION PROGRAM			
#	Trigger Type	Stop An. Dry Cont.	Oper. to Start
1		Ana. Sen 2	---
2	Ana. Sen 1	Dry Con 2	---
3	Ana. Sen 2	Dry Con 14	---
4	Ana. Sen 3	<NONE>	---
5	Ana. Sen 4	<NONE>	---
6	Ana. Sen 5	<NONE>	---
7	Ana. Sen 6	<NONE>	---
8		<NONE>	---

e. Under Oper. to Start, choose the required symbol.

EXTERNAL CONDITION PROGRAM			
#	Stop An. Dry Cont.	Oper. to Start	Start Value
1	Ana. Sen 2	>	
2	Dry Con 2	---	---
3	Dry Con 14	---	<
4	<NONE>	---	<=
5	<NONE>	---	=
6	<NONE>	---	>
7	<NONE>	---	>=
8	<NONE>	---	

f. Under Oper. To Stop, choose the required symbol.

EXTERNAL CONDITION PROGRAM			
#	Oper. to Start	Start Value	Oper. to Stop
1		25	=
2	---	---	---
3	<	---	---
4	<=	---	---
5	=	---	---
6	>	---	---
7	>=	---	---
8	---	---	---

g. Under Start Value, enter the required value to start the analog sensor. Under Stop Value, entered the required value to stop the analog sensor.

INSTALLATION MENU

EXTERNAL CONDITION PROGRAM			
#	Start Value	Oper. to Stop	Stop Value
1	25	=	20
2	---	---	---
3	---	---	---
4	---	---	---
5	---	---	---
6	---	---	---
7	---	---	---
8	---	---	---

In the examples given above, irrigation has been set to start when the analog input is greater than 25 and irrigation stops when the input is 20.

Oper. to Start and Oper. to Stop require a logical operation. The following table defines these symbols:

Symbol	Definition
---	No operation
<, <=	The analog sensor function value is less than/less than or equal to the start/stop value.
=	The analog sensor function value is equal to the start/stop value. There is a $\pm 1\%$ allowable deviation.
>, >=	The analog sensor function value is greater than/greater than or equal to the start/stop value.

12.5 Analog Output

△ The information here replicates the information found in Section 4.5.6, Analog Output Definition, page 42.

△ Install analog output cards.

ANALOG OUTPUT			
Channel		Dosing Channel	No.
Local	1	Dosing Channel	1
Local	2	Dosing Channel	2
Local	3	Dosing Channel	3
Local	4	<None>	--
Local	5	<None>	--
Local	6	<None>	--
Local	7	<None>	--
Local	8	<None>	--

This screen enables controlling the dosing channels valves using a 4 - 20 mA current.

- **Channel:** Read only data listing the analog output channel numbers.
- **Dosing Channel:** Select dosing channel to enable analog-controlled pumping. When set to **None**, [Venturi](#) driven injectors control the dosing.
- **No.:** Map the channel number to the dosing channel.

△ After defining and mapping the channels, go to [Configuration > Dosing Channel Configuration](#) (page 116).

12.6 Hardware Checklist

Same as **Hardware Check List** screen from **TEST** section (Menu 6.6).

13 CONTROLLER ADVANCED SETTINGS

- Pump Station Configuration, page 130
- Multiple Water Meters, page 131
- Drain Meter Measurement, page 132
- Various Dosing Channel Configurations, page 134
- Dosing Configuration, page 135
- Dual EC/pH Sensors, page 136
- Hot Keys and Status Screens, page 138
- Operation Mode, page 138

13.1 Pump Station Configuration

1

2

3

Pump No.	CapCapacity m3/h	Stability mm:ss	Off Delay mm:ss
1	50.000	--:--	--:--
2	70.000	00:10	00:10
3	80.000	00:15	00:15
4	100.000	--:--	--:--

Stability: Time between each pump start
Off Delay: Time delay between switching each pump Off

4 Pumps 1, 2 & 3 form a station

Pump No.	Stability mm:ss	Off Delay mm:ss	Station
1	--:--	--:--	YES
2	00:10	00:10	YES
3	00:15	00:15	YES
4	--:--	--:--	NO

5

6

Valve No.	Pump	Main Valve	Water Meter	Drain Meter
1	Pump 4	1	1	--
2	Pump 4	1	1	--
3	Station	2	2	--
4	Station	2	2	--
5	Station	2	2	--

First pump to start will be the biggest, first pump to stop will be the smallest

Valves 1 & 2 allocated to Pump 4
Valves 3, 4 & 5 allocated to station of pumps 1, 2 & 3

CONTROLLER ADVANCED SETTINGS

13.2 Multiple Water Meters

- Option A - Standard Use/M Measurement
- Option B - Multiple Water Sources

13.2.1 Option A - Standard Use/M Measurement

1. Main menu: 1. Program, 2. Manual, 3. Alarm, 4. History, 5. Setup, 6. Setup, 7. Config, 8. Install. **SELECT** (7. Config)

2. CONFIGURATION menu: 1. DEVICE DELAY CONFIGURATION, 2. PUMP STATION CONFIGURATION, 3. VALVE CONFIGURATION, 4. VALVE FLOW RATE, 5. WATER METER CONFIGURATION, 6. DOSING CHANNEL CONFIGURATION, 7. DOSING CONFIGURATION, 8. EC PRE-CONTROL CONFIGURATION, 9. DRAINAGE CONFIGURATION, 10. SYSTEM PRESSURE CONFIGURATION.

3. WATER METER table:

Description	Ratio	Type
Water Meter 1	100.000	STANDARD
Water Meter 2	100.000	STANDARD
Water Meter 3	10.000	STANDARD
Water Meter 4	10.000	STANDARD
Water Meter 5	60.000	STANDARD
AUX Meter 1	---	---
AUX Meter 2	---	---
AUX Meter 3	---	---
AUX Meter 4	---	---
AUX Meter 5	---	---

4. CONFIGURATION menu: 1. DEVICE DELAY CONFIGURATION, 2. PUMP STATION CONFIGURATION, 3. VALVE CONFIGURATION, 4. VALVE FLOW RATE, 5. WATER METER CONFIGURATION, 6. DOSING CHANNEL CONFIGURATION, 7. DOSING CONFIGURATION, 8. EC PRE-CONTROL CONFIGURATION, 9. DRAINAGE CONFIGURATION, 10. SYSTEM PRESSURE CONFIGURATION.

5. VALVE CONFIGURATION table:

Valve No.	PUMP	Main Valve	Water Meter	Drain Meter
1	PUMP 1	1	---	---
2	PUMP 1	1	---	---
3	PUMP 1	1	4/4/3	---
4	PUMP 1	1	4/4/3	---
5	PUMP 1	1	---	---

Enter capacity and type for additional water meters

Configure meters to valves
Ex: Valves 3, 4 & 5 are allocated to water meters 2, 3 & 4 consecutively

! Only 1 water meter can be measured at a time.

13.2.2 Option B - Multiple Water Sources

This option is used for water management, meters are located before the irrigation system.

NOTE: Cannot allocate a water meter to a valve.

The controller will simulate a virtual water meter with a calculated flow of $WM1+WM2+WM3+WM4$.

Water Meter 3

Tank 1

Tank

Water Meter 1

Water Meter 2

Water Meter 4

Water

Drain Water

! ATTENTION

Water Meter Table 1:

Description	Ratio	Type
Water Meter 1	100.000	STANDARD
Water Meter 2	100.000	STANDARD
Water Meter 3	10.000	STANDARD
Water Meter 4	10.000	STANDARD
Water Meter 5	60.000	STANDARD
AUX Meter 1	---	---
AUX Meter 2	---	---
AUX Meter 3	---	---
AUX Meter 4	---	---
AUX Meter 5	---	---

Water Meter Table 2:

Description	Type	Sub
Water Meter 1	STANDARD	---
Water Meter 2	STANDARD	---
Water Meter 3	STANDARD	---
Water Meter 4	STANDARD	---
Water Meter 5	STANDARD	---
AUX Meter 1	---	---
AUX Meter 2	---	---
AUX Meter 3	---	---
AUX Meter 4	---	---
AUX Meter 5	---	---

CONTROLLER ADVANCED SETTINGS

13.3 Drain Meter Measurement

Use this option for greenhouses drain applications.

Option A- Total

Option B: Sample

Collect sample from drain of 1 lateral=simulate the total amount of drain water per valve/shift

Total

Sample

Measure delay:

On delay= time it takes for water to get through the system.

Off Delay= time after irrigation it takes for water to fully drain and stop drain measurement.

Meter No.	Ratio Liter/Pulse	On Delay	Off Delay
1	1.000	00:05:00	00:10:00

13.3.1 Drainage Timing Option A

Use this option when irrigating one valve is which allocated to a drain meter.

Drain

08:30 08:35 09:00 09:10 09:20 09:30

CONTROLLER ADVANCED SETTINGS

13.3.2 Drainage Timing Option B

Use this option when irrigating two consecutive valves which allocated to the same drain meter.

Meter No.	Ratio Liter/Pulse	On Delay	Off Delay
1	1.000	00:05:00	00:10:00
---	---	---	---
---	---	---	---
---	---	---	---
---	---	---	---
---	---	---	---
---	---	---	---
---	---	---	---
---	---	---	---
---	---	---	---

Valve No.	Main Valve	Water Meter	Drain Meter	Drain Type
1	-	-	-	Total
4	-	-	-	Sample

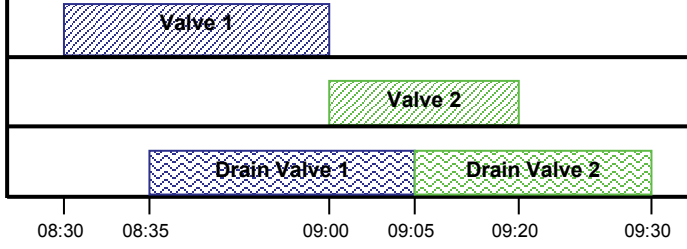
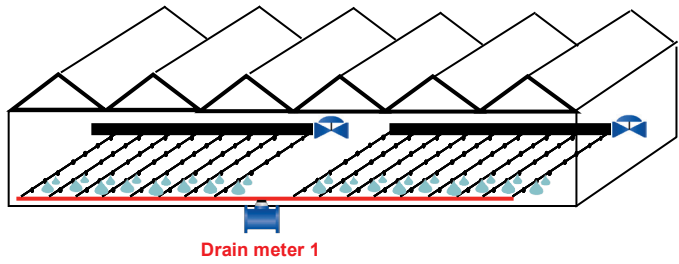

NOTE: Valve 2 "On Delay" is taking control of valve 1 "Off Delay".
Means that valve 1 drain measurement finished while valve 2 drain measurement just started

DRAIN LOG



HISTORY
1. IRRIGATION LOG
2. UNCOMPLETED IRRIGATION
3. DAILY IRRIGATION
4. IRRIGATION ACCUMULATION
5. WATER & GUY METER ACCU. FILTERS
6. ACCUMULATION RESET
7. COOLING

History Menu

Date	Time	UI	Drain %	Drain
08:30	08:30	274	100.00	1450
08:35	08:35	417	50.00	1700
08:40	08:40	110	70.57	1100
08:45	08:45	239	100.00	1400
08:50	08:50	254	62.50	500
08:55	08:55	217	100.00	800
09:00	09:00	118	10.75	150
09:05	09:05	55	100.00	850

View drainage history log:
1st column - drain percentages of total
2nd column - real drain amount (liter or Gallon)

CONTROLLER ADVANCED SETTINGS

13.4 Various Dosing Channel Configurations

- Method 1
- Method 2
- Method 3

13.4.1 Method 1

- Dosing Pump control = Calculated according to Nominal Flow Rate
- Dosing pump measurement = Calculated according to Fert. Meter
- Dosing pump type = Venturi or Electric

Inject fertilizer according to nominal capacity of pump/measure from fertilizer meter for verification purposes

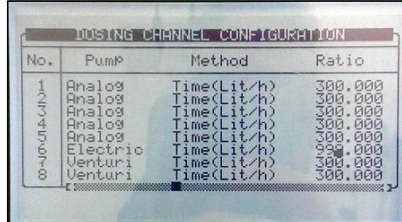
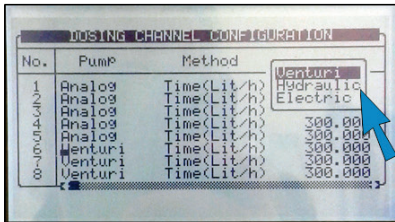

Set nominal pump capacity

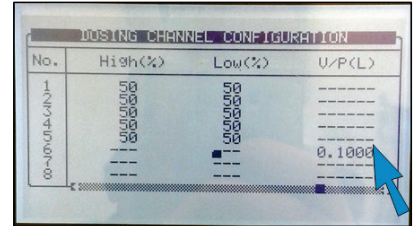

Set dosing meter ratio V/P of dosing meter, = volume per pulse in liter (L) or gallon (G)



Alarm Menu

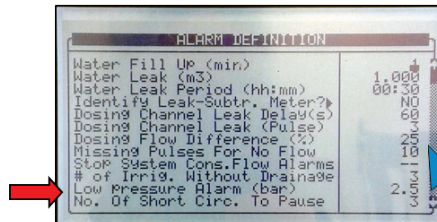

Set alarm when the difference between the nominal dosing flow and the measured dosing flow is ±xx% (default set at recommended 25%)

13.4.2 Method 2

- Dosing Pump control = Calculated according to Nominal Flow Rate
- Dosing pump measurement = Calculated according to dosing pump flow rate
- Dosing pump type = Venturi or Electric

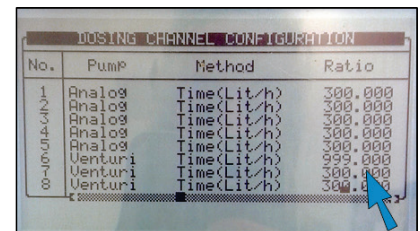
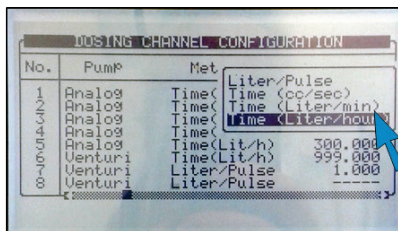
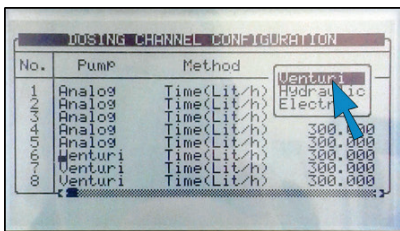

CONTROLLER ADVANCED SETTINGS

13.4.3 Method 3

- Dosing Pump control = According Fert. meter pulses (For quantitative injection only)
- Dosing pump measurement = Fert. Meter
- Dosing pump type = Hydraulic

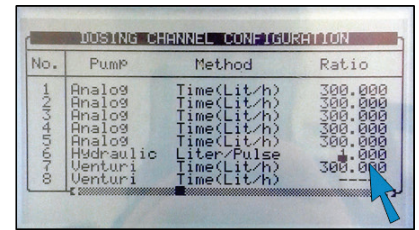
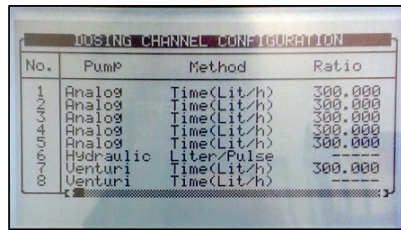
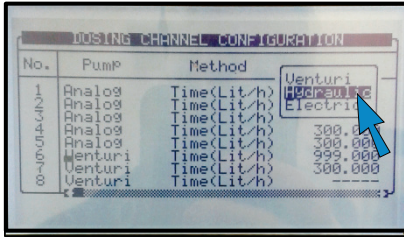

13.5 Dosing Configuration



Type of each channel configured by technician during installation process

- EC- channel influenced by EC levels
- ACID- channel to inject acid to reduce pH levels
- PASSIVE- no EC/pH influence
- ALKALI- channel to increase pH levels

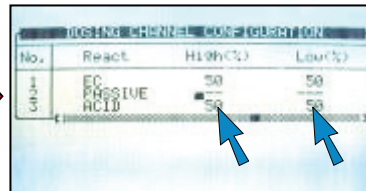

DOSING CONFIGURATION	
EC Coarse Tuning	5
EC Fine Tuning	5
pH Coarse Tuning	5
pH Fine Tuning	5
Control Cycle EC	4
Control Cycle pH	4
EC/pH Averaging (0-Low, 20-High)	3
Dosing Boost Off Delay (mm:ss)	00:02
Dosing by QTY. Method	SPREAD

EC/pH coarse tuning- when way off target, faster/stronger correction

EC/pH fine tuning- off target is low, slow/light correction

EC/pH Control cycle- Delay time from fertilizer/Acid injection point to EC/pH sensors reading

EC/pH averaging- balanced reading from EC/pH sensors

Dose boost off delay- time clear water circulated through system after fertigation stops and venturi closes

CONTROLLER ADVANCED SETTINGS

13.6 Dual EC/pH Sensors

Additional sensors as fail-safe and to verify if difference occurs; alarms signal.



Enter sensor difference to set alarm

Install sensors as in section 7.4

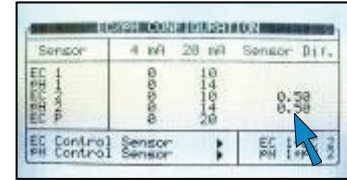
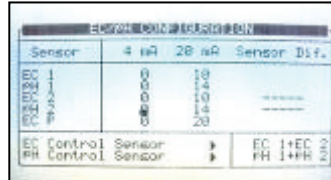

Select action and delay if 1 sensor fails, sensor 2 activated

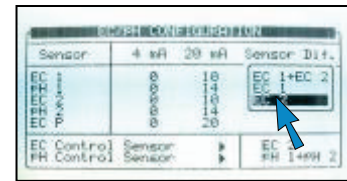

DUAL EC/pH SENSORS- Additional sensors as fail-safe and to verify if difference occurs, alarm will signal.

End day time

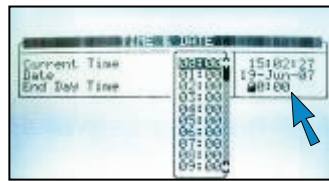
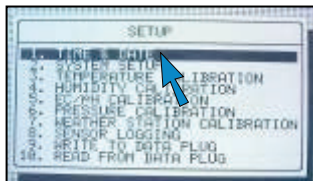

Stop time for measuring water and dosing accumulating information from irrigation valves and dosing channels

Max. cooling parallel



Max. misting parallel



Define cooling/misting valve/pump

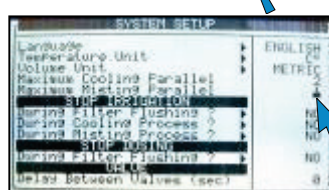
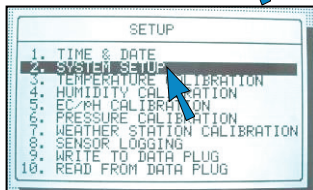
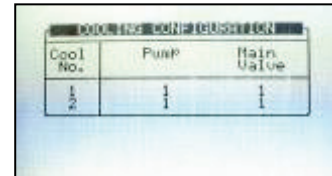

Set max. cooling/misting programs working together



NOTE: Operate max # cooling/misting programs according to system water pressure limit.

CONTROLLER ADVANCED SETTINGS



Set to pause irrigation during cooling/misting process, then resume irrigation



Set to pause irrigation during filter flushing process, then resume irrigation



Set to pause dosing during filter flushing process, then resume irrigation

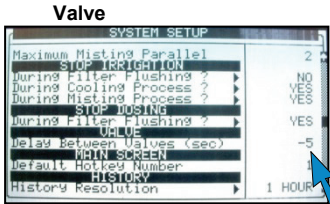

Set delay between valves or set to overlap valves in order to create pressure before opening them by pressing +/- key

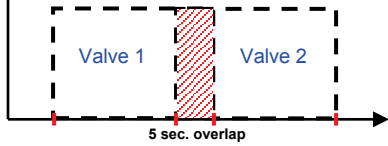

5 second delay

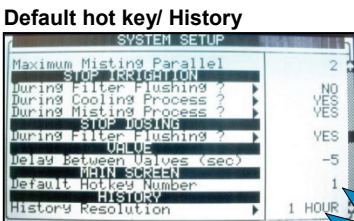
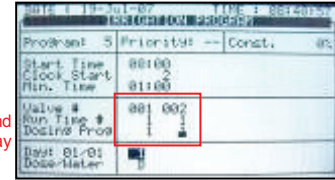
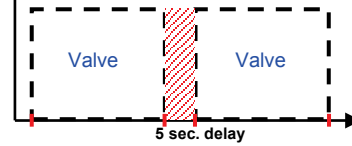

Change setting of default hot key that will be present for the grower as a default.

Set history resolution-how often system saves information

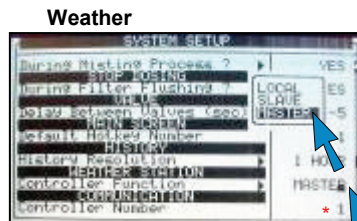

Local – Only one controller network

Master- connected to station, transfers data to slave controller

Slave- more than 1 controller network, not connected to station but receive data by communication to the Master

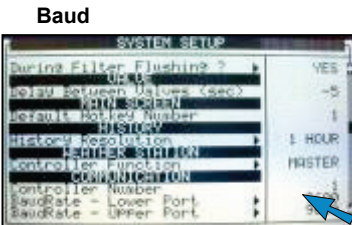

Select baud rate of communication:

Lower Port - Controllers and PC

CONTROLLER ADVANCED SETTINGS

13.7 Hot Keys and Status Screens

In the Active Irrigation screen, view the status of the system by pressing number keys corresponding to each hot key.

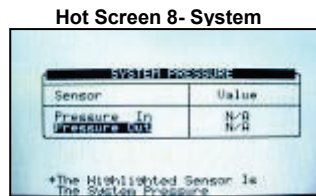
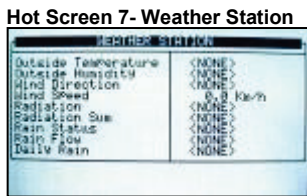
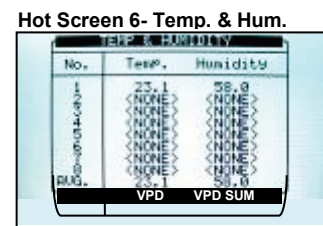
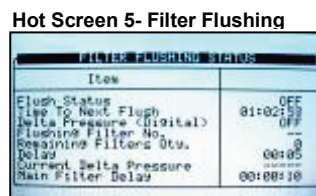
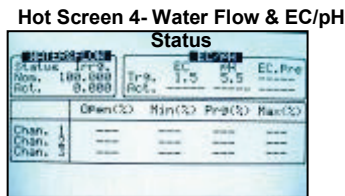
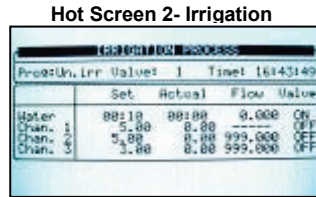
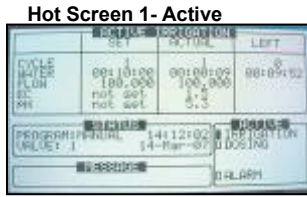

13.8 Operation Mode

There are three levels of operation:

- **Read Only (restricted):** All the parameters and menus are visible, but cannot be modified
- **User (partially restricted):** Menus 1-6 are fully accessible and can be modified. Menus 7 and 8 can be viewed but not modified
- **Technician (unrestricted):** All menus are fully accessible (no restrictions)

To change the operation mode, select **Mode**.

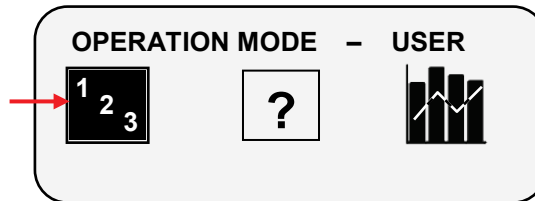

On the Front Panel, press **Zone/Log In**.

The controller recognizes the operation mode according to the password that is entered:

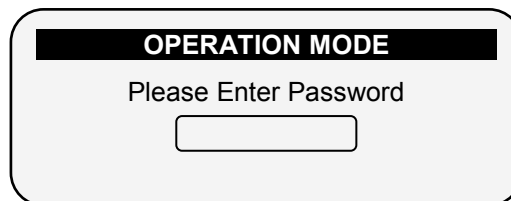

CONTROLLER ADVANCED SETTINGS

MODE	PASSWORD
Read Only	0000
User	9785 or 0101
Technician	38845

If an incorrect password is entered, then this screen will appear:

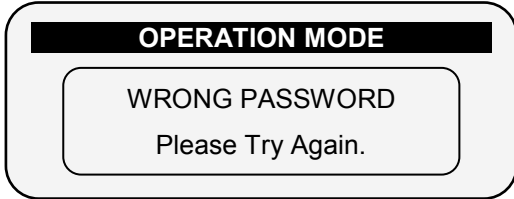

The Operation mode can be configured to automatically return to the “Read-Only” mode after a certain amount of time.

 **Note:** Refer to the **10.2 System Setup** section.

SYSTEM SETUP	
HISTORY	
History Resolution ▶	1 HOUR
WEATHER STATION	
Controller Function ▶	LOCAL
OPERATION MODE	
Automatic return to RO mode ▶	NO
Return period to RO mode ▶	00:10
COMMUNICATION	
Controller Number ▶	1
Lower Port – Protocol ▶	NMC NET
Lower Port – Baudrate ▶	9600
Upper Port – Protocol ▶	NONE
Upper Port – BaudRate ▶	9600

- To perform a **cold start** or **firmware upgrade**, the controller must be in the “**Technician**” mode.
- If there is a power failure, the controller will power up with the last mode that used.

14 APPENDIX A – NMC-PRO PARTS LIST

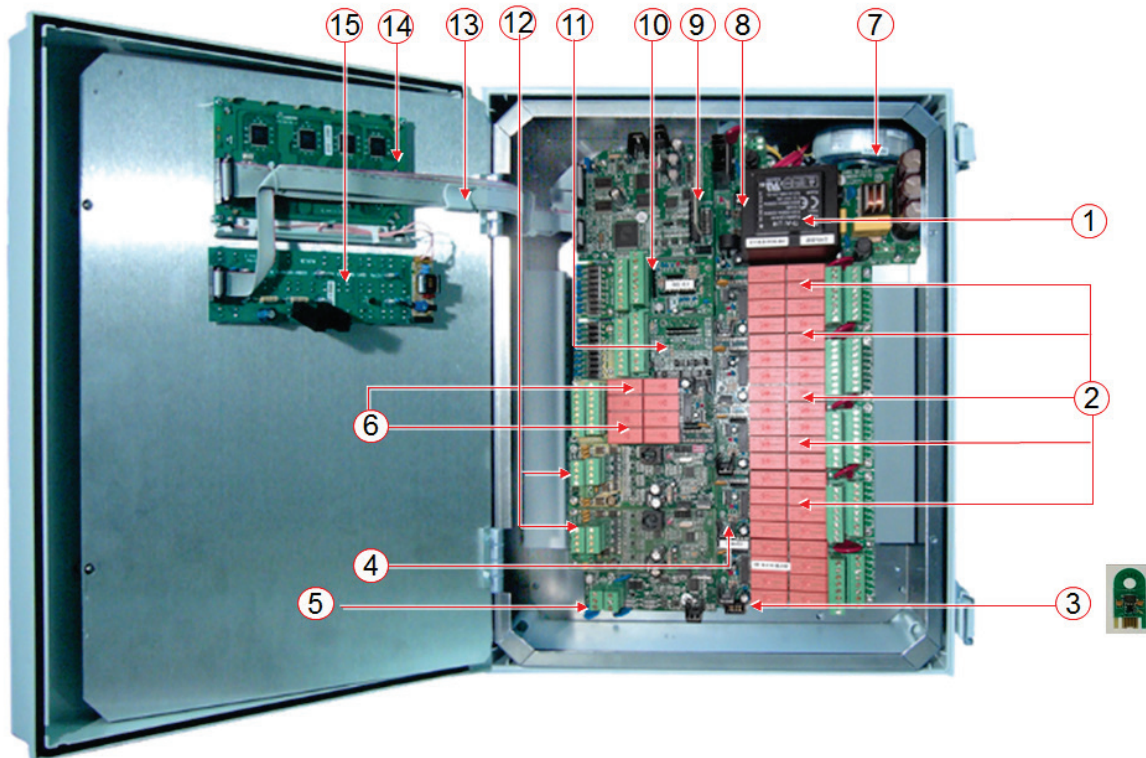

NMC-PRO Parts List Continued

Item #	Description	Part #
1	NMC-PRO/64 Power supply card 115VAC	74340-007900
	NMC-PRO/64 Power supply card 230VAC	74340-008000
	NMC-PRO/64 12VDC power supply card	74340-009300
2	NMC-PRO/64 24V AC output cards, 8 outputs	74340-008500
3	NMC-PRO Memory backup key – Data Plug	74340-014500
4	NMC-PRO/64 Input/Output BUS card	74340-007800
5	NMC-PRO/64 Communication card RS-232	74340-009100
	NMC-PRO/64 Communication card RS-485	74340-009200
6	NMC-PRO/64 Dry Contact output card, 8 outputs	74340-008600
7	NMC-PRO/64 115/24V AC Transformer	74340-008050
	NMC-PRO/64 230/24V AC Transformer	74340-008100
8	NMC-PRO SD card	74340-014650
9	NMC-PRO CPU Card	74340-014600
10	NMC-1PRO/64 Digital Input Card, 8 inputs	74340-008800
11	NMC-PRO/64 Analog Input Card, 11 inputs	74340-008900
12	NMC-PRO Analog Output Card, 4 outputs	74340-008910
13	NMC-PRO/64 flat cable set for small plastic box	74340-008300
	NMC-PRO/64 flat cable set for large plastic box	74340-020800
	NMC-PRO/64 flat cable set for NetaJet enclosure	74340-008400
14	NMC-PRO/64 Display card with fluorescent (old type)	74340-007600
	NMC-PRO Display card with LED backlit (new type)	74340-004920
15	NMC-PRO/64 Keyboard card for Fluorescent display (old type)	74340-007700
	NMC-PRO Keyboard card for LED backlit display (new type)	74340-003300

TROUBLESHOOTING

15 APPENDIX B – TROUBLESHOOTING

- Controller Malfunction
- Burnt Fuse - In Case of Voltage

15.1 Controller Malfunction

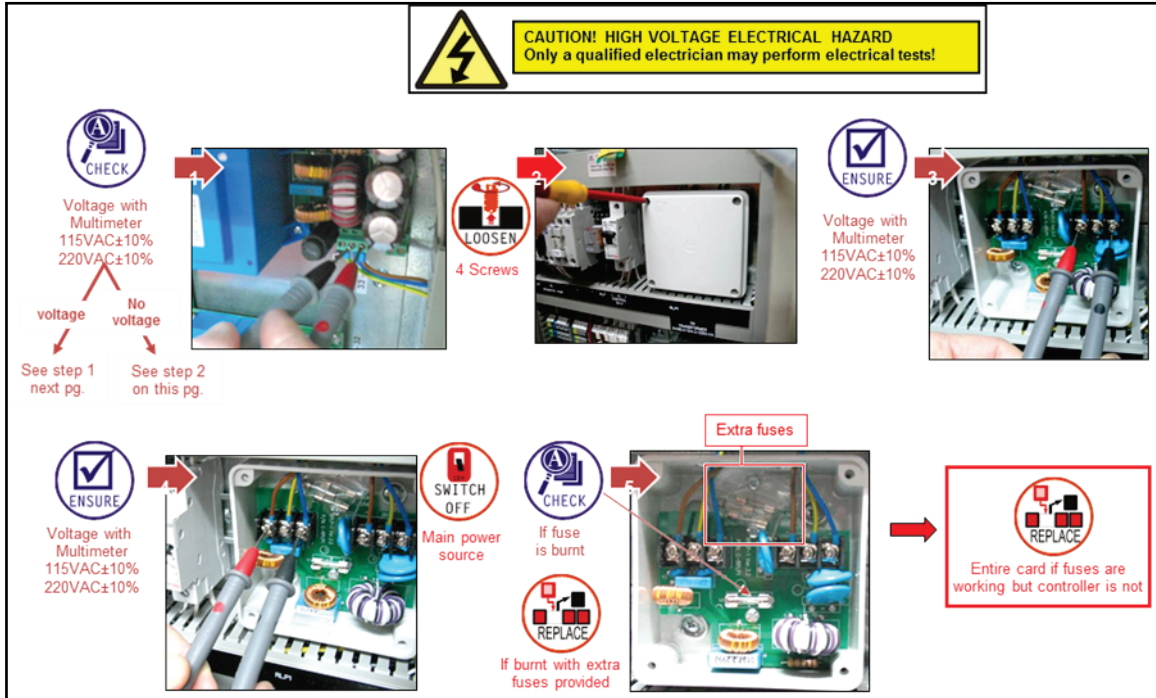

15.2 Burnt Fuse - In Case of Voltage

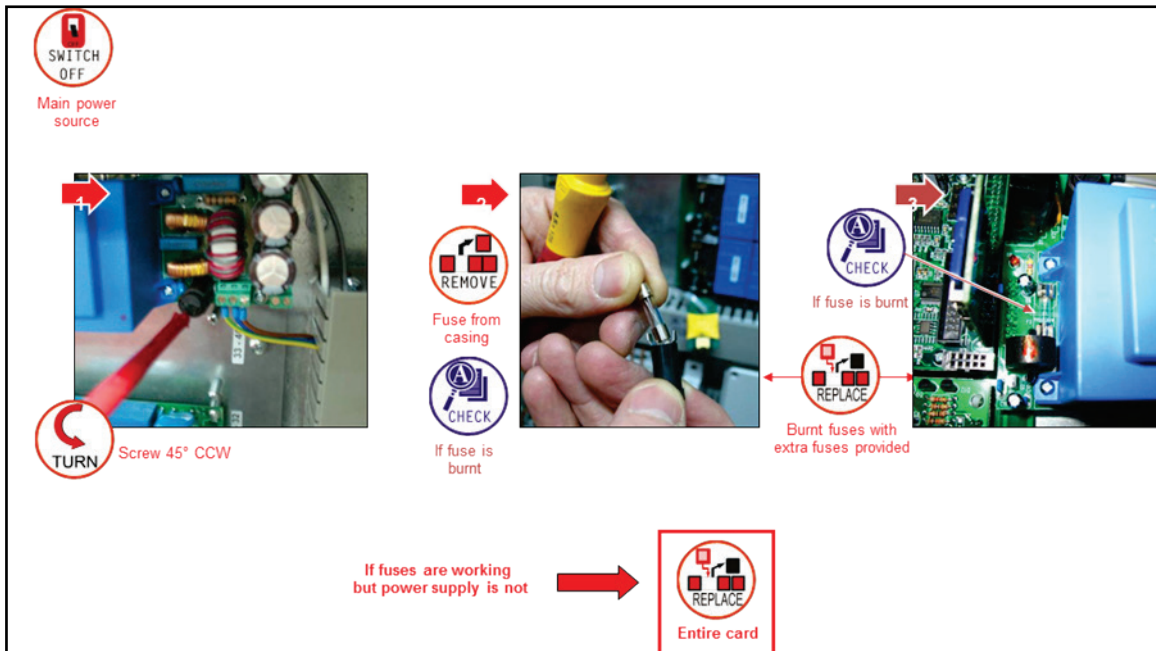

16 APPENDIX C – REPLACEMENTS AND ADDITIONAL INSTALLATIONS

- Installing a 24 VAC Output Card, page 142
- Removing a Card, page 143
- Adding a Dry Contact Output Card, page 143
- Adding an Input Card, page 144
- LCD & Keyboard Replacement, page 145

16.1 Installing a 24 VAC Output Card

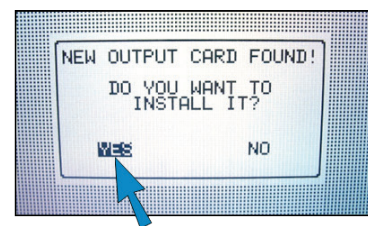
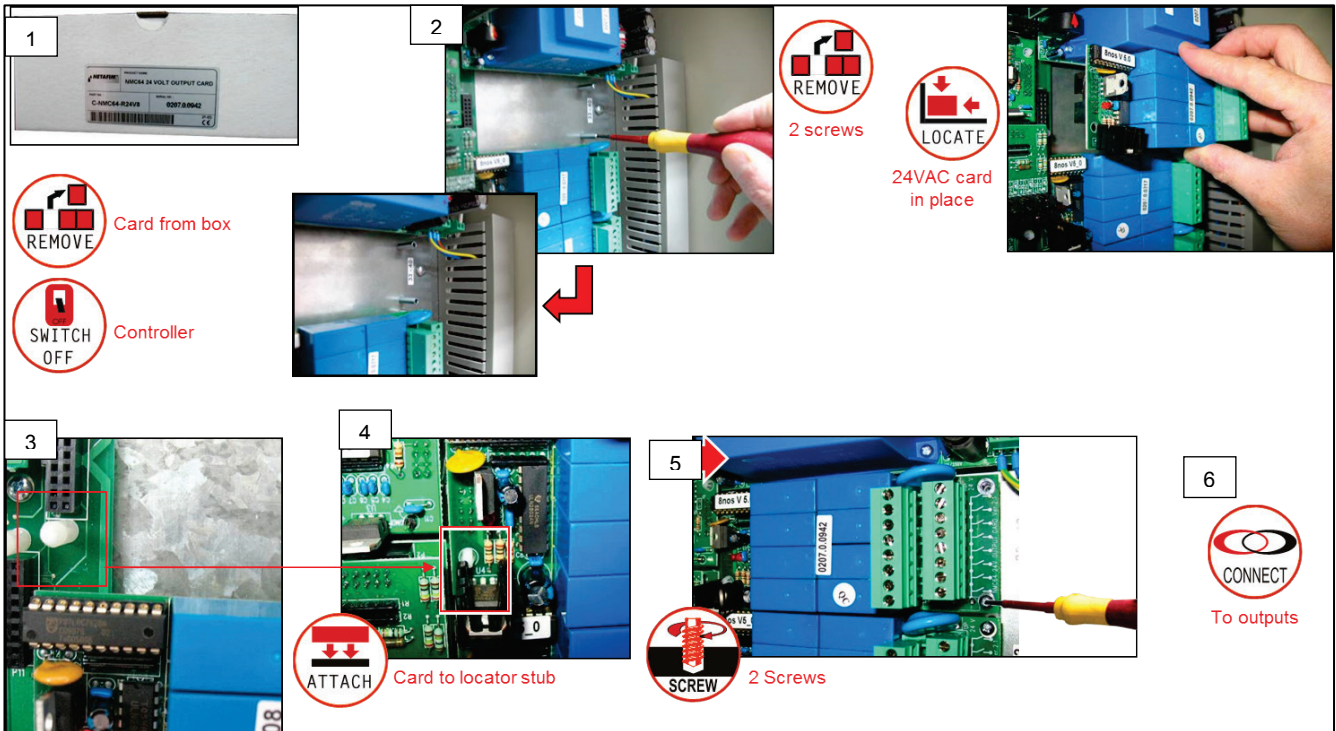



REPLACEMENT AND ADDITIONAL INSTALLATIONS

16.2 Removing a Card

Note: The procedure is the same for all cards.

1  **Controller**

2  **Wires**
2 Screws

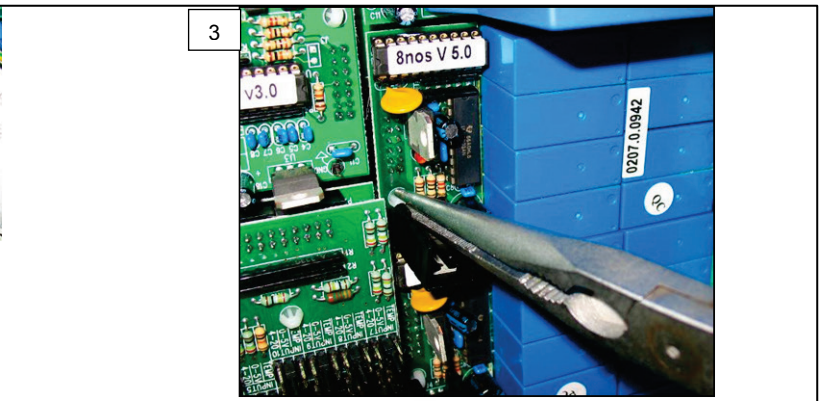
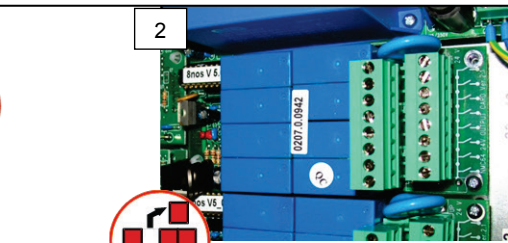
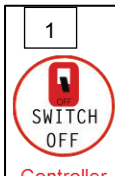

3  **TOOLS** **Pliers**  **PERFORM** Use pliers to squeeze stub back through hole and gently manipulate card forward to remove





16.3 Adding a Dry Contact Output Card

1  **Card from box**

2  **2 screws**

3  **LOCATE** **Dry Contact card in place**  **CONNECT** **Low terminal to power supply and high terminal to outputs**

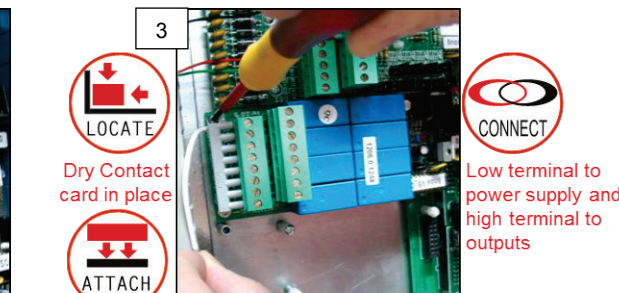
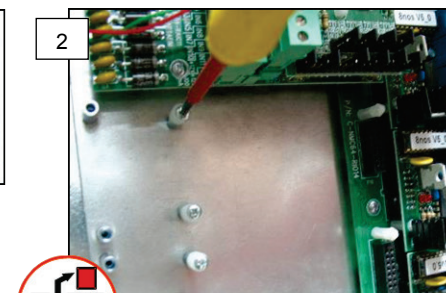
ATTACH **Card as above**



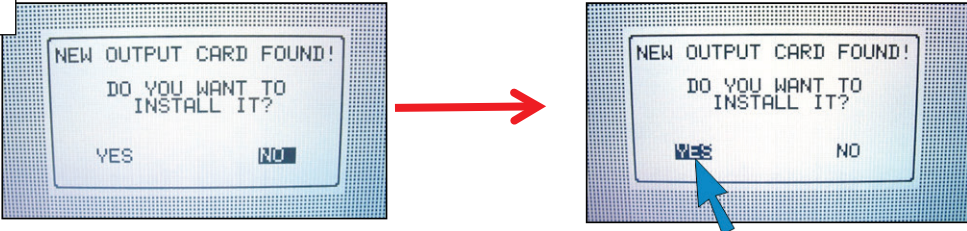

4  **Controller**

5 

REPLACEMENT AND ADDITIONAL INSTALLATIONS

16.4 Adding an Input Card

1  Card from box



REMOVE 

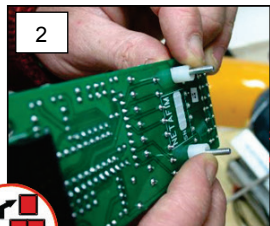

SWITCH OFF  Controller

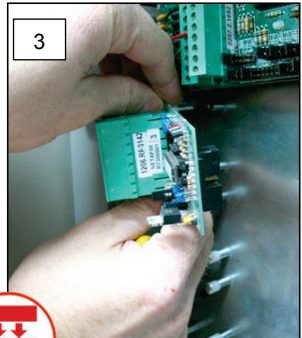

2  Standoffs and screws from back wall

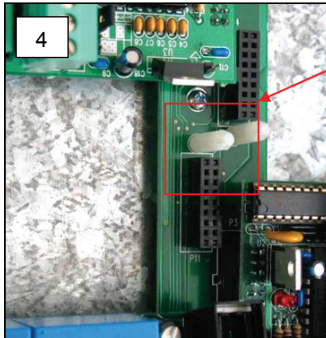

REMOVE 

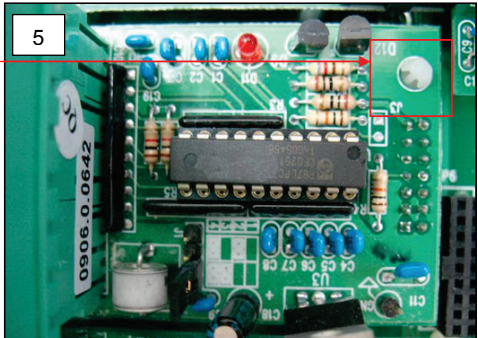

ATTACH  Standoffs to back of card

3   **ATTACH**

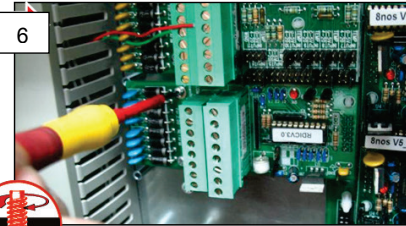
4  **LOCATE**  Stub

5  **ATTACH**  Jumper to terminal 2

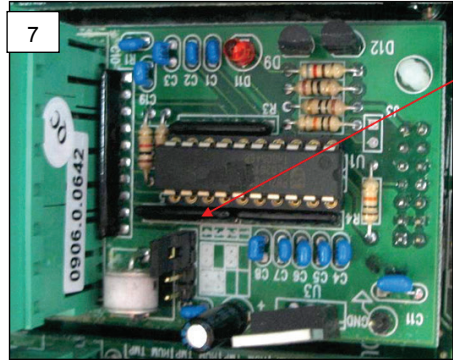
6  **SCREW**  2 Screws

7  **ATTACH**  Jumper to terminal 2

SWITCH ON 

NEW INPUT CARD FOUND!
DO YOU WANT TO INSTALL IT?
YES NO

NEW INPUT CARD FOUND!
DO YOU WANT TO INSTALL IT?
YES NO

 Note: Analog Input card installed in same way without jumper.

REPLACEMENT AND ADDITIONAL INSTALLATIONS

16.5 LCD & Keyboard Replacement

If LCD or keyboards are no longer in working condition first recognize if your LCD or keyboard is an OLD or NEW version.

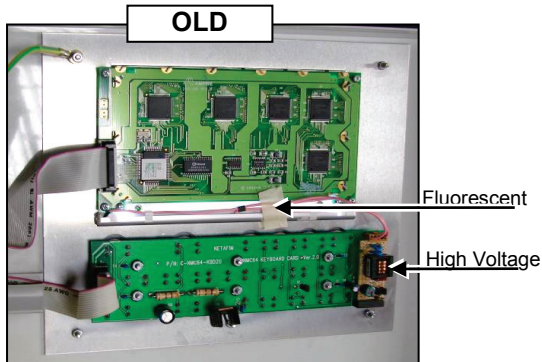

Old LCD SAP# : 74340-007600
Old Keyboard SAP#: 74340-007700

Refer to the next page for the old version.

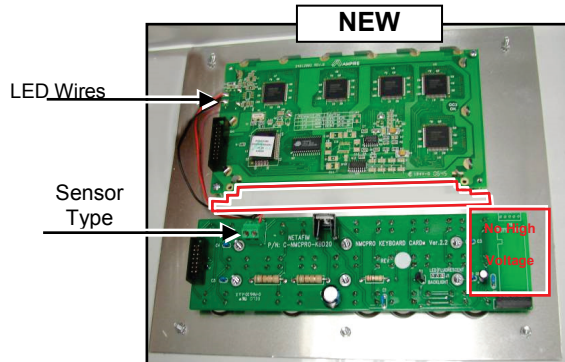

New LCD - SAP #: 74340-004920
New Keyboard - SAP#: 74340-003300

Refer to the following page for the new version.

16.5.1 NMC-PRO: Old LCD & Keyboard Replacement

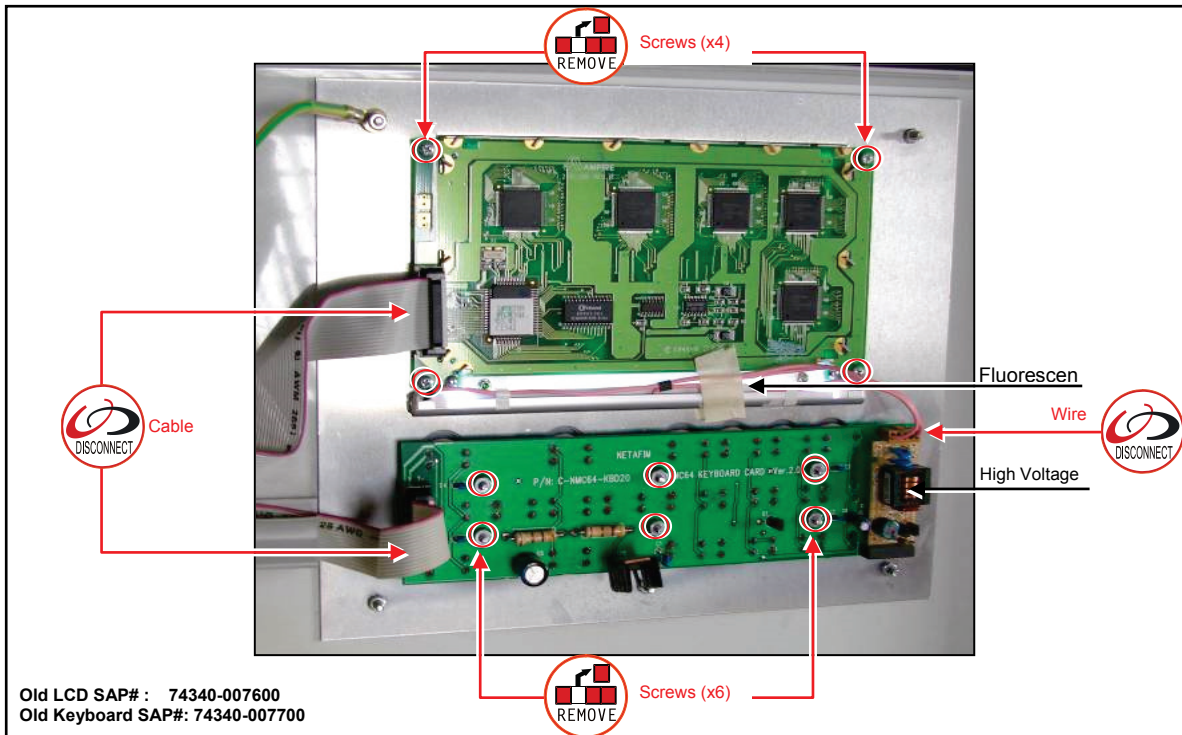

REPLACEMENT AND ADDITIONAL INSTALLATIONS

16.5.2 NMC-PRO: New LCD & Keyboard Replacement

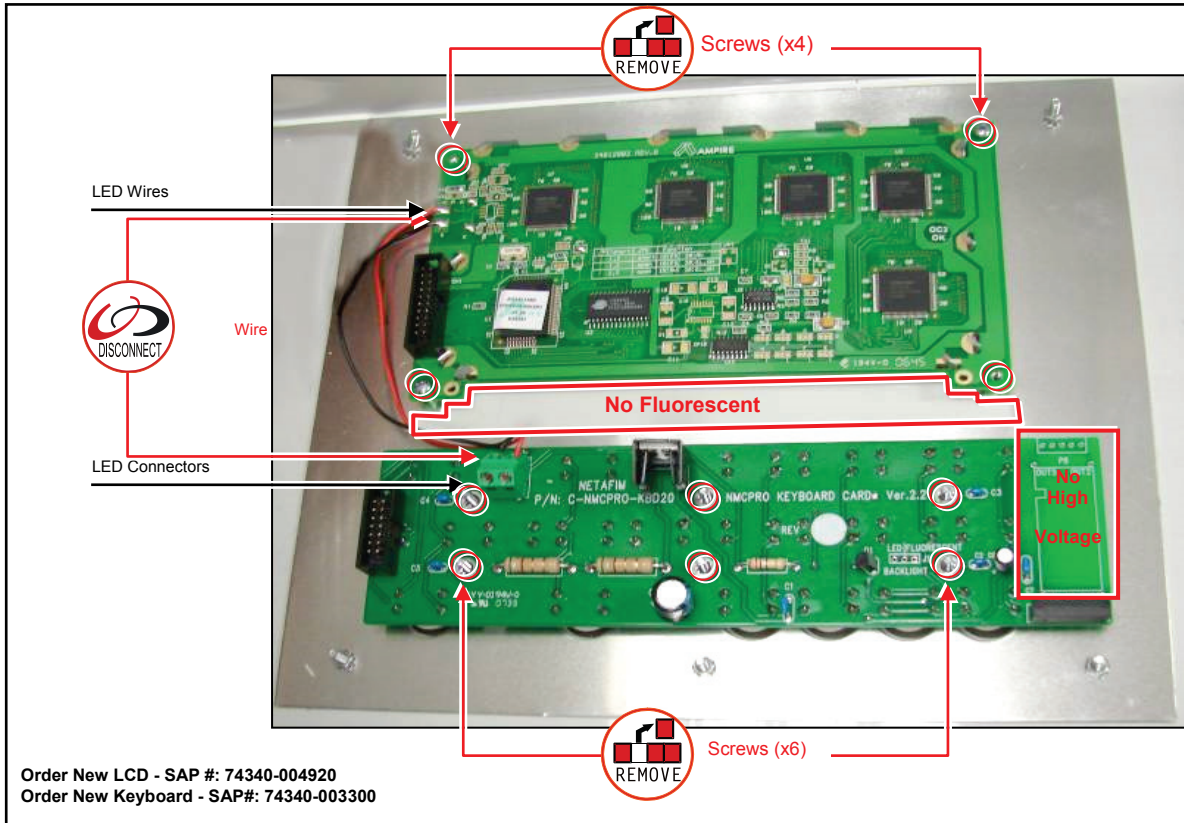

17 APPENDIX D - SENSOR INSTALLATION AND DEFINITION

- EC – pH Sensor Connection, page 147
- Measuring Box Connection, page 151
- Humidity Sensor Definition, page 152
- Pyranometer Connection – Netafim, page 154
- Radiation Sensor Definition, page 155
- Pressure Transducer Connection, page 157
- Wind Direction Connection, page 159
- Sensor and Cable Specifications, page 161

17.1 EC – pH Sensor Connection

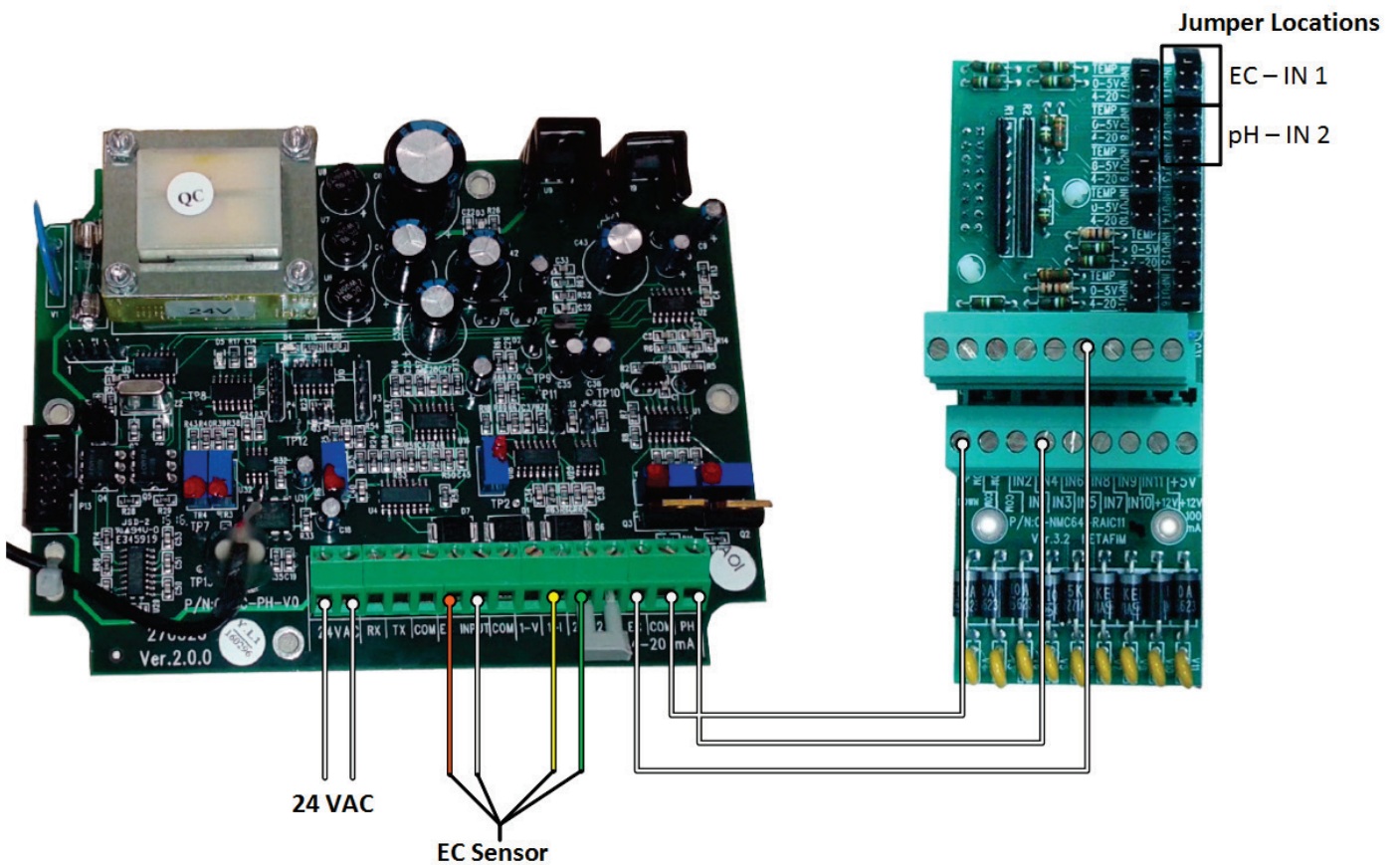

Jumper Position	Sensor type
Temp	Temperature sensor (30 ohm)
0 – 5V	Humidity, Radiation, Pressure
4 – 20 mA	EX, pH

- EC Sensor Calibration, page 148
- pH Sensor Calibration, page 149
- Pro pH Calibration, page 150

SENSOR INSTALLATION AND DEFINITION

17.1.1 EC Sensor Calibration

1. On EC/pH screen press **MENU**.



EC Calibration appears.



2. Press **Enter**. Calib 1.4 appears.



3. Press **Enter**.



4. Clean and dry an EC sensor. Insert the sensor into 1.4mS calibration buffer; immerse for 10 seconds and press **Enter**.



Calibration is in process.



5. When the following screen appears, remove the sensor from the buffer and hold it in the air; press Enter.

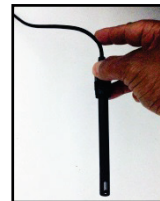

6. Calibration is in process; wait until next screen is displayed, which indicates that EC Calibration is complete.



7. Wait until the following screen appears.



EC calibration is complete.

 **NOTE:** If display says "BUFFER FAULT" please refer to Troubleshooting in the EC-pH Manual.

1. On EC/pH screen, press **MENU**.

SENSOR INSTALLATION AND DEFINITION

17.1.2 pH Sensor Calibration



EC calibration appears.



2. Press **Select** to scroll down to pH CALIBRATION.



3. Press **Enter**.



4. Verify that the pH sensor is dry; insert it into a pH 7 calibration buffer, immerse for 10 seconds, and press **Enter**.



The following screen appears.



5. Calibration is in process, wait until the following screen appears.



6. Verify that the pH sensor is dry; insert it into a pH 4 calibration buffer, immerse for 10 seconds, and press **Enter**.



The following screen appears.



7. Wait until the following screen appears.



pH calibration is complete.

 **NOTE:** If display says "BUFFER FAULT" please refer to Troubleshooting in the EC pH Manual.

SENSOR INSTALLATION AND DEFINITION

17.1.3 Pro pH Calibration

1

TIME & DATE
SYSTEM SETUP
3. TEMPERATURE CALIBRATION
4. HUMIDITY CALIBRATION
5. EC/pH CALIBRATION
6. PRESSURE CALIBRATION
7. WEATHER STATION CALIBRATION
8. SENSOR LOGGING
9. WRITE TO DATA PLUG
READ FROM DATA PLUG

SELECT

In Setup select EC/pH Calibration

2

Sensor	Value	Factor
EC	1.60	0.00
pH	6.00	-0.36
Pressure	<NONE>	---
Humidity	<NONE>	---

Press (-) Arrows to Increase/Decrease

3

Save Changes?

YES NO

CHECK

IF EC and pH numbers match on both screens; if not:

Use arrows to increase/decrease value so numbers match

- ENTER when values match
- Press Menu

SENSOR INSTALLATION AND DEFINITION

17.2 Measuring Box Connection

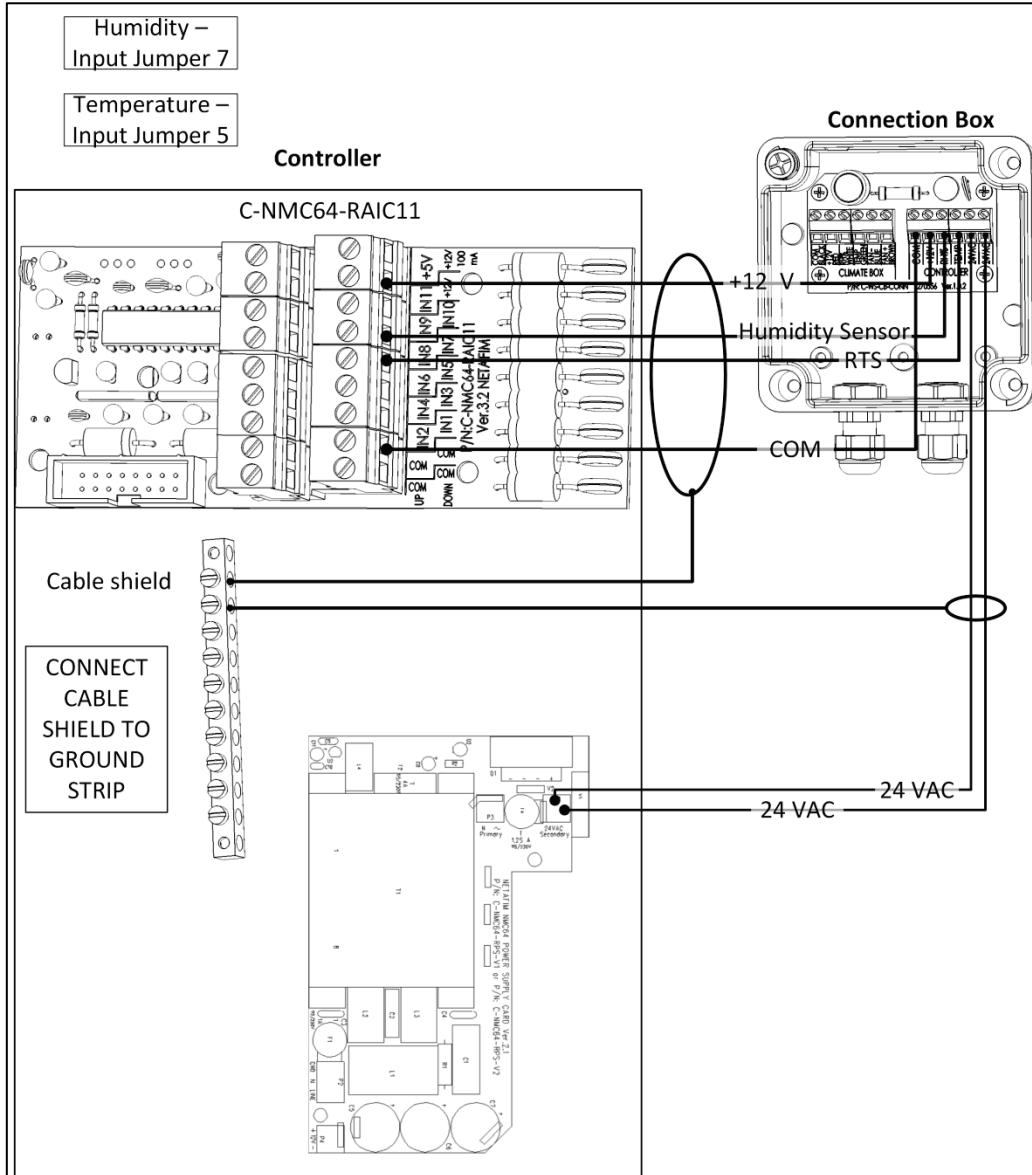

NOTE: Can wire 24 VAC terminals of measuring box to 24 VAC on the output terminals.

Jumper positioning	Sensor type
Temp	Temperature Sensor (30 kOhm)
0 – 5 V	Humidity
4 – 20 mA	EC, pH, CO2

WARNING! TO ENSURE INTERFERENCE AND LIGHTNING IMMUNITY, USE SHIELDED CABLE ONLY (22 AWG MINIMUM)!

WARNING! POWER AND SIGNAL WIRES MUST BE IN SEPARATE CABLES!

17.3 Humidity Sensor Definition



Measuring Box

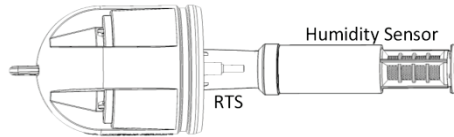

Humidity/Temp Sensor

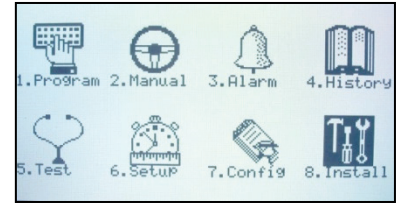

INSTALLATION		
1.	DEVICE LAYOUT	
2.	DEVICE LIST	
3.	DIGITAL INPUT 1	
4.	DIGITAL INPUT 2	
5.	ANALOG INPUT 1	
6.	ANALOG INPUT 2	
7.	HARDWARE CHECKLIST	

ANALOG INPUT 1		
Channel	Input Function	No.
1	EC Sensor	00. <None>
2	pH Sensor	01. Temp Sensor
3	< None	02. Humidity Sensor
4	< None	03. EC Sensor
5	< None	04. pH Sensor
6	< None	05. EC Sens. Verify

ANALOG INPUT 1		
Channel	Input Function	No.
1	EC Sensor	1
2	pH Sensor	1
3	Temp Sensor	1
4	< None	-
5	< None	-
6	< None	-

ANALOG INPUT 1		
Channel	Input Function	No.
1	EC Sensor	00. <None>
2	pH Sensor	01. Temp Sensor
3	Temp Sensor	02. Humidity Sensor
4	< None	03. EC Sensor
5	< None	04. pH Sensor
6	< None	05. EC Sens. Verify

ANALOG INPUT 1		
Channel	Input Function	No.
1	EC Sensor	1
2	pH Sensor	1
3	Temp Sensor	1
4	Humidity Sensor	-
5	< None	-
6	< None	-

- Outside Temperature/Humidity Sensor Connection
- Sensor Definition

SENSOR INSTALLATION AND DEFINITION

17.3.1 Outside Temperature/Humidity Sensor Connection

GndN Line

10	Calibration in process
Sensor from buffer	
Lithium Battery for backup	
SingleNet License key	



Cable type
4x0.5mm² (20AWG)

Sensor Wires
Temp&Hum sensor: Black - COM
Hum sensor: White - Input
Temp sensor: Red - Input
Hum sensor: Red -

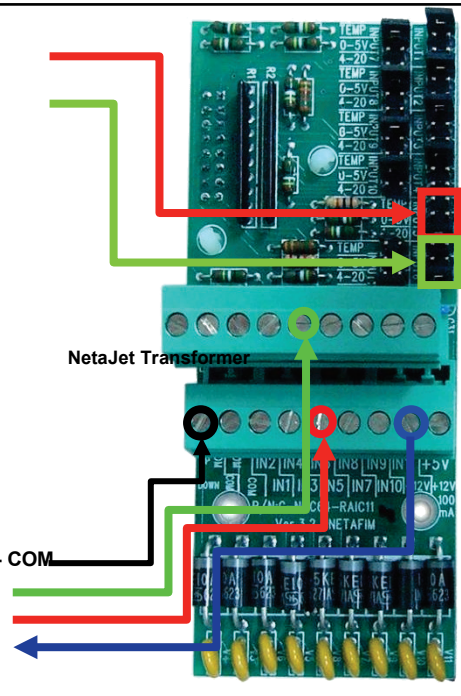

17.3.2 Sensor Definition

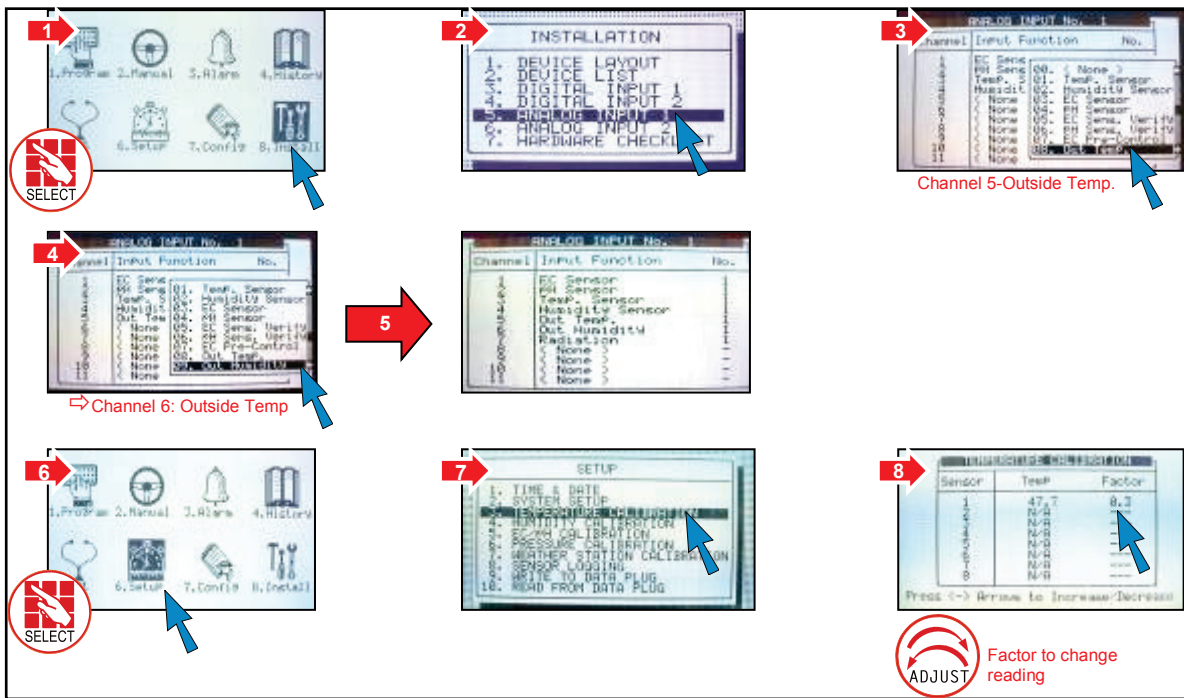

1. Main menu with options: 1. Program, 2. Manual, 3. Alarm, 4. History, 5. Setup, 6. System, 7. Config, 8. Install. A red 'SELECT' icon is shown over the 'Setup' option.
2. 'INSTALLATION' menu with options: 1. DEVICE LAYOUT, 2. DEVICE LIST, 3. DIGITAL INPUT 1, 4. DIGITAL INPUT 2, 5. ANALOG INPUT 1, 6. ANALOG INPUT 2, 7. HARDWARE CHECKLIST. A red arrow points to option 5.
3. 'ANALOG INPUT No. 1' menu with a table:

Channel	Input Function	No.
1	EC Sensor	00
2	Temp. Sensor	01
3	Humidity Sensor	02
4	EC Sensor	03
5	Temp. Sensor	04
6	Humidity Sensor	05
7	EC Sensor	06
8	Temp. Sensor	07
9	Humidity Sensor	08
10	EC Sensor	09
11	Temp. Sensor	10
12	Humidity Sensor	11

Channel 5-Outside Temp.
4. 'ANALOG INPUT No. 1' menu with a table:

Channel	Input Function	No.
1	EC Sensor	00
2	Temp. Sensor	01
3	Humidity Sensor	02
4	EC Sensor	03
5	Temp. Sensor	04
6	Humidity Sensor	05
7	EC Sensor	06
8	Temp. Sensor	07
9	Humidity Sensor	08
10	EC Sensor	09
11	Temp. Sensor	10
12	Humidity Sensor	11

Channel 6: Outside Temp
5. A red arrow points from step 4 to step 6.
6. Main menu with options: 1. Program, 2. Manual, 3. Alarm, 4. History, 5. Setup, 6. System, 7. Config, 8. Install. A red 'SELECT' icon is shown over the 'Setup' option.
7. 'SETUP' menu with options: 1. TIME & DATE, 2. SYSTEM SETUP, 3. SYSTEM CALIBRATION, 4. SYSTEM IDENTIFICATION, 5. SYSTEM LOGGING, 6. SYSTEM LOGGING, 7. SYSTEM LOGGING, 8. SYSTEM LOGGING, 9. SYSTEM LOGGING, 10. READ FROM DATA PLUG.
8. 'Sensor' calibration screen with a table:

Sensor	Temp	Factor
1	47.7	0.3
2	N/A	N/A
3	N/A	N/A
4	N/A	N/A
5	N/A	N/A
6	N/A	N/A
7	N/A	N/A
8	N/A	N/A

Factor to change reading

SENSOR INSTALLATION AND DEFINITION

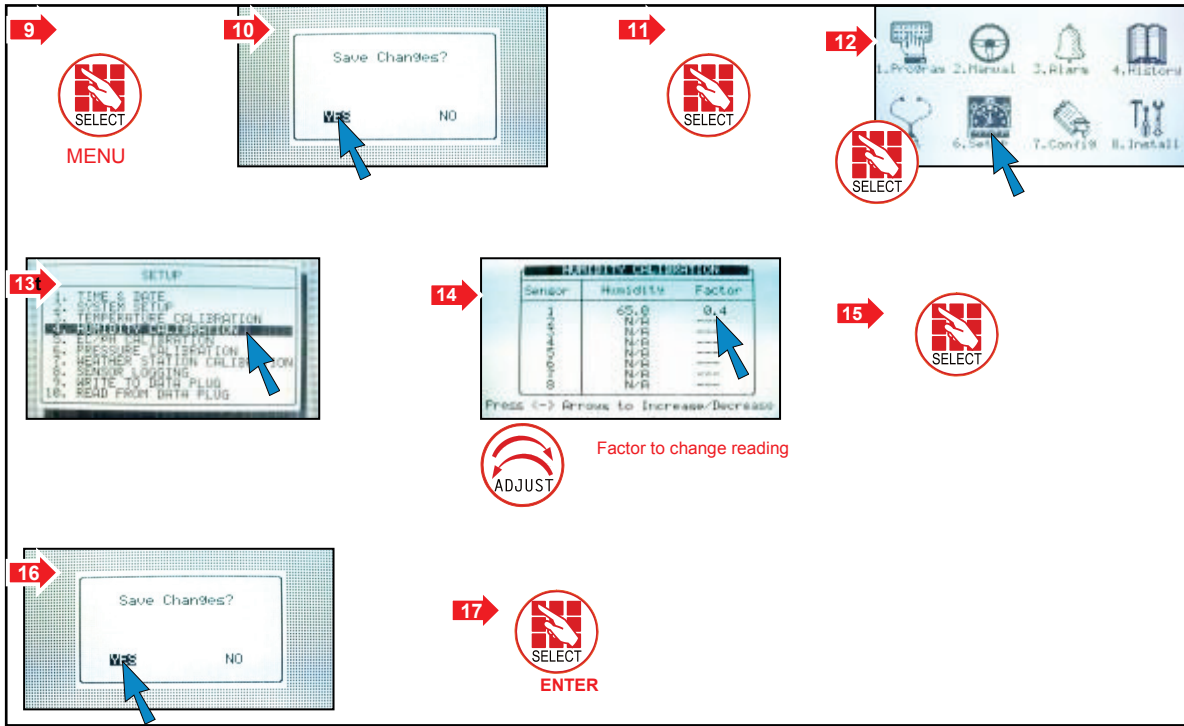

17.4 Pyranometer Connection – Netafim1

Pyranometer: IN7 Jumper Location →

Jumper Position	Sensor type
Temp	Temperature sensor (30kΩ)
0-5V	Sensor Type
4-20 mA	EC, pH, CO2 . . .

Cable Type:
3 x 0.5 mm² (20 AWG) Shielded

Sensor Wires:
Green: COM
White: Input
Brown: +12VDC

SENSOR INSTALLATION AND DEFINITION

17.5 Radiation Sensor Definition

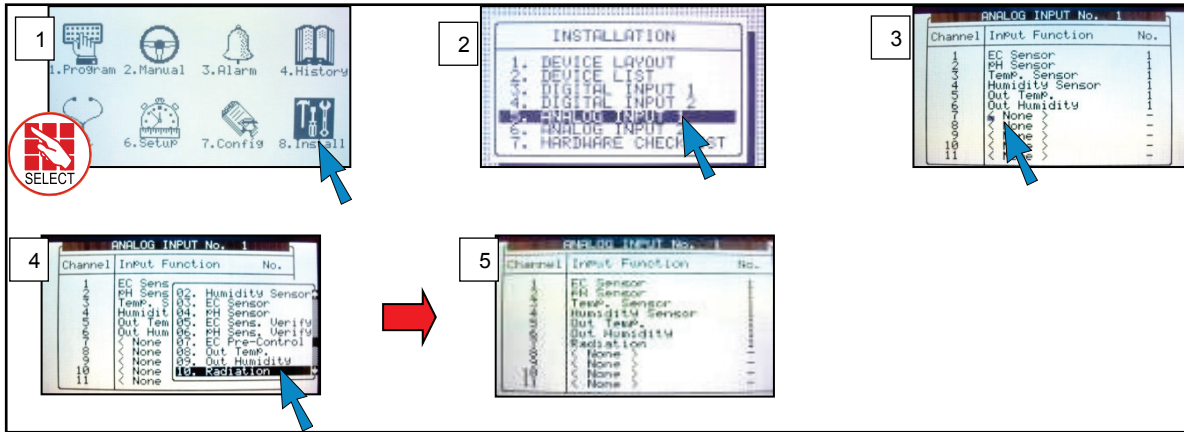

- Radiation Sensor Configuration – Netafim
- Radiation Sensor Connection – Davis

17.5.1 Radiation Sensor Configuration – Netafim

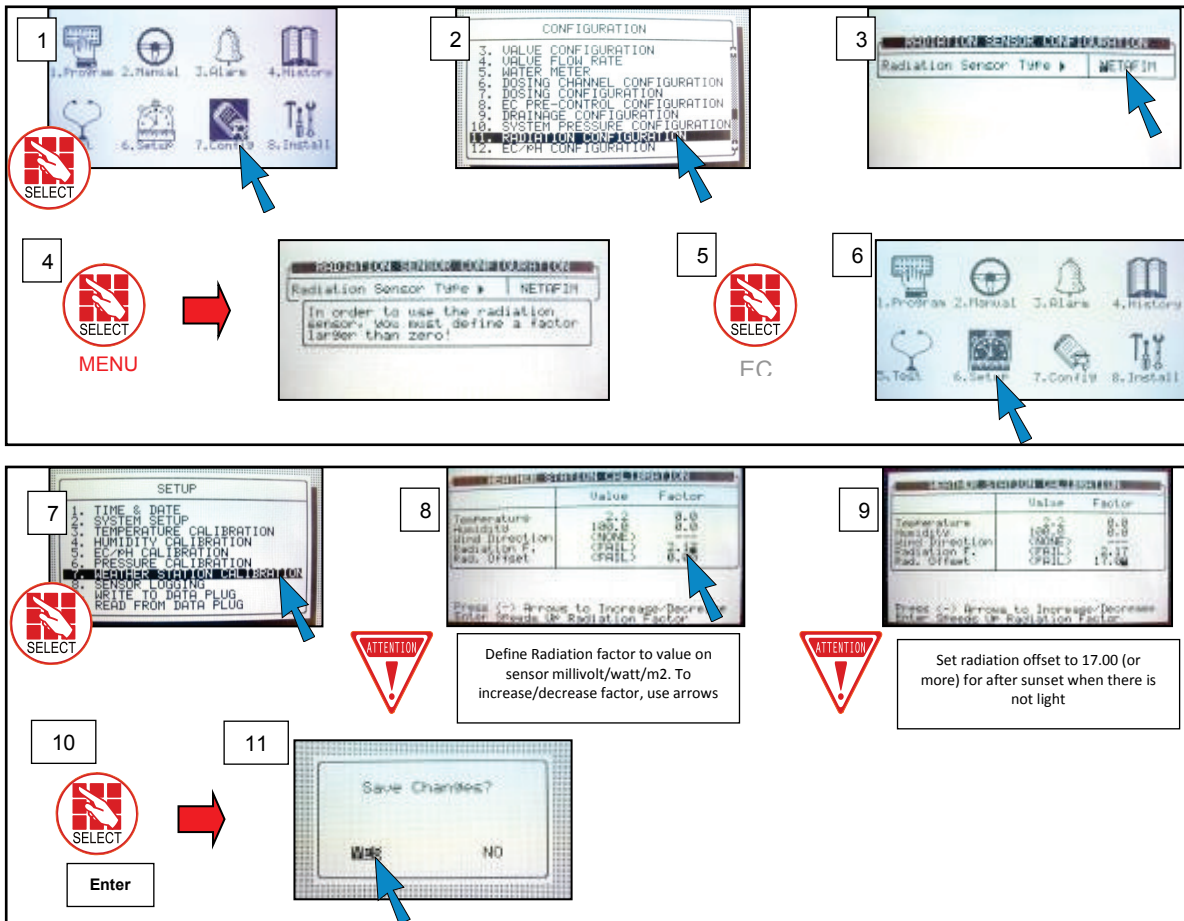

SENSOR INSTALLATION AND DEFINITION

17.5.2 Radiation Sensor Connection – Davis

Jumper Position	Sensor type
Temp	Temperature Sensor (30kΩ)
0-5V	Radiation
4-20 mA	EC, pH, CO2 . . .

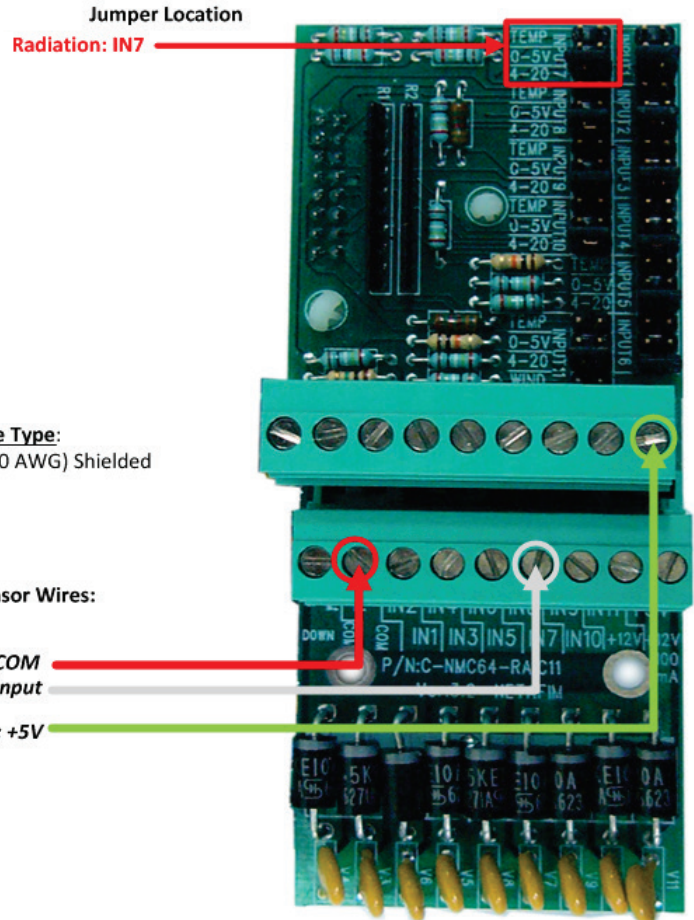

Cable Type:
3 x 0.5 mm2 (20 AWG) Shielded



Sensor Wires:

- Red: COM**
- White: Input**
- Green: +5V**

17.5.2.1 Radiation Sensor Definition



SENSOR INSTALLATION AND DEFINITION

17.5.2.2 Radiation Sensor Configuration - Option B- Davis

1. Main menu: Program, Manual, Alarm, History, Test, Setup, Config, Install. **SELECT** (MENU)

2. CONFIGURATION menu: VALUE CONFIGURATION, VALUE FLOW RATE, WATER METER, DOSING CHANNEL CONFIGURATION, EC PRE-CONTROL CONFIGURATION, DRAINAGE CONFIGURATION, SYSTEM PRESSURE CONFIGURATION, **RADIATION SENSOR CONFIGURATION**, EC/PH CONFIGURATION.

3. RADIATION SENSOR CONFIGURATION: Radiation Sensor Type: **NETAFIM**. **ENTER** to show options.

4. Radiation Sensor Type: **Davis**. **ENTER** and press **ENTER**.

5. **SELECT** (MENU)

6. Main menu: Program, Manual, Alarm, History, Test, Setup, Config, Install.

7. SETUP menu: TIME & DATE, SYSTEM SETUP, TEMPERATURE CALIBRATION, HUMIDITY CALIBRATION, EC/PH CALIBRATION, PRESSURE CALIBRATION, **RADIATION SENSOR CONFIGURATION**, SERIAL PORT, WRITE TO DATA PLUG, READ FROM DATA PLUG.

8. Radiation Factor: Value: 1.67, Factor: 1.67. **ENTER** to increase/decrease factor speed or radiation factor.

9. **SELECT** (MENU)

10. Save Changes? **YES** NO

17.6 Pressure Transducer Connection

Jumper positioning	Sensor type
Temp	Temperature sensor (30kΩ)
0-5V	Pressure inlet, Pressure outlet
4-20mA	Pressure inlet, Pressure outlet

Pressure inlet – IN 8 : (Red line)

Pressure outlet – IN 9 : (Green line)

Cable type: 3x0.5mm² (20AWG) Shielded

Filter Station: P in - COM, P in - Input, P out - COM, P out - Input

SENSOR INSTALLATION AND DEFINITION

17.6.1 Analog Pressure Sensor Definition

1 [Main Menu] → **2** INSTALLATION → **3** Channel 8 - Pressure

4 Channel 9 - Pressure → **5** [Main Menu] → **6** CONFIGURATION

7 Low Pressure Alarms → In Sensor / Out Sensor

8 CONFIGURATION → **9** Define units 0-5V or 4-20 mA according to sensor range (ex: 0-10 bar)

10 [Main Menu] → **11** [Main Menu] → **12** SETUP → **13** CHECK

Netafim pressure sensor specifies:
 0.5 Volt = -1.25 bar
 4.5 Volt = 11.25 bar

Pressure value matches value on pressure gauge of main line

SENSOR INSTALLATION AND DEFINITION

17.7 Wind Direction Connection

Jumper positioning	Sensor type
Temp	Temperature sensor (30KΩ)
0-5V	Humidity, Radiation, Pressure
4-20 mA	EC, pH, CO2
Wind Dir (only input)	Wind direction sensor

Jumper location
Wind d: IN11

Cable type:
4.0 x 5 mm² (20 AWG)

To digital input card

Sensors

Black: DI

Red: COM

Green: Input

Yellow: +5V

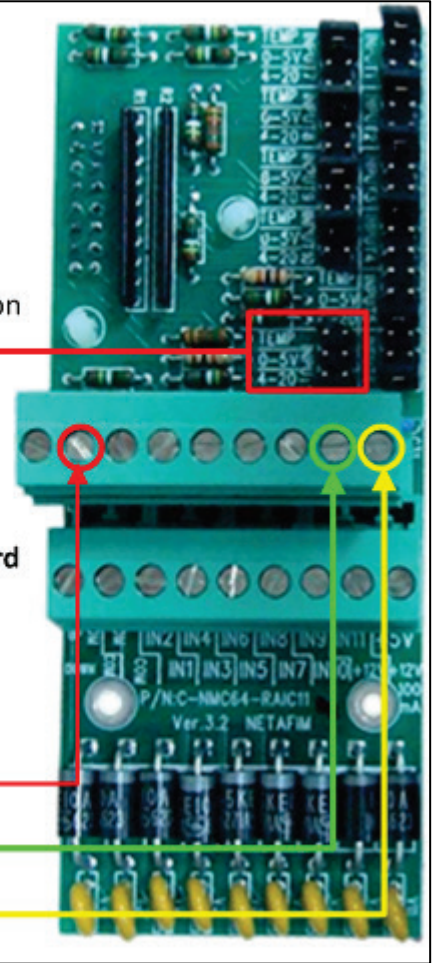

- Wind Direction Sensor Definition
- Wind Speed Digital Input Definition

SENSOR INSTALLATION AND DEFINITION

17.7.1 Wind Direction Sensor Definition

1 SELECT

2 INSTALLATION

3 Wind direction in channel 11

4 SETUP

5 ADJUST Wind direction using a compass

6 Enter value in the controller

17.7.2 Wind Speed Digital Input Definition

1 SELECT

2 INSTALLATION

3 DIGITAL INPUT

SENSOR INSTALLATION AND DEFINITION

17.8 Sensor and Cable Specifications

Sensor Type	Measured Values	Accuracy	Input Range	Maximum Cable Length	Cable Type
Temperature – RTS-s	-20° to 50° C/ -4° to 122°F	0.3°C/0.54°F	30 kOhm	500 meter (1640 feet)	2x0.5 mm ² (20 AWG)
EC	0 to 10 mS (old transmitters used 20 mS)	0.05 to 0.1 mS	4 – 20 mA	---	3x0.5 mm ² (20 AWG) Shielded
pH	0 - 14	0.1	4 – 20 mA	---	
RH – RHS-10	0 – 100%	±2% (10%-90% RH), ±3.5% (90%-100% RH)	0 – 3 VDC	300 meter (985 feet)	3x0.5 mm ² (20 AWG)
Solar Radiation-Davis	300-1100 nanometer (Up to 1500W/m ²)	±5%	0 – 3 VDC	100 meter (330 feet)	3x0.5 mm ² (20 AWG) Shielded
Pyranometer-Netafim	300-2800 nanometer (Up to 1500 W/m ²)	±5%	0 – 5 VDC	---	
Wind Direction	0 - 360°	±7%	0 – 20 kOhm	100 meter (330 feet)	4x0.5 mm ² (20 AWG)
Wind Speed	4-280 km/hr (2-175 mph)	±5%	Pulse output (Wind Cups & Magnetic Switch)		
Pressure	Up to 10bar (145 PSI)	Check data sheet of the sensor used	0 – 5 VDC	Check data sheet of the sensor used	3x0.5mm ² (20 AWG) Shielded
Rain Collector	Rain amount (mm or inch) Collection area: 200 cm ² (31 inch ²) Resolution: 0.254mm (0.01")	±2%, Rainfall count between 0.2-50 mm/hr (0.01 - 2"/hr) ±3%, Rainfall count between 50-150 mm/hr (2-4"/hr)	Dry contact (tipping bucket)	100 meter (330 feet)	---
Rain Detector	Rain, No Rain	0.2mm/hr	Dry contact/ 0-5 VDC		

18 APPENDIX E- TECHNICAL SPECIFICATIONS

- Technical Specifications
- Controller Components

18.1 Technical Specifications

Housing	Plastic housing with a screw on lid	IP 65
	Dimensions (L x W x H)	30 x 40 x 18 cm (11.81 x 15.75 x 7.08 inches)
	Weight	6.0 kg / 13.2 lbs.
Ambient Conditions	Operating temperature range	0 to +50 Celsius (14 to 122 Fahrenheit)
	Storage temperature range	-10 to +70 Celsius (14 to 158 Fahrenheit)
Approvals	The 115/230VAC has Safety CE approval	EN61010-1
	EMC approvals CE and FCC	EN55011 Group1 Class A EN61000-3-3; EN61000-6-2; CISPR 11 GROUP 1 CLASS A FCC Part 15 Subpart B

18.2 Controller Components

- Keyboard & Display, page 162
- CPU, page 163
- Power Supply, page 163
- Digital Input, page 165
- Analog Input, page 165

18.2.1 Keyboard & Display

- Graphical LCD Display
- Back light
- 5.5"



- Tactile feel Keyboard



TECHNICAL SPECIFICATIONS

18.2.2 CPU

- 32bit CPU
- 8Mb Flash memory
- Settings backup & software upgrade through SD memory card

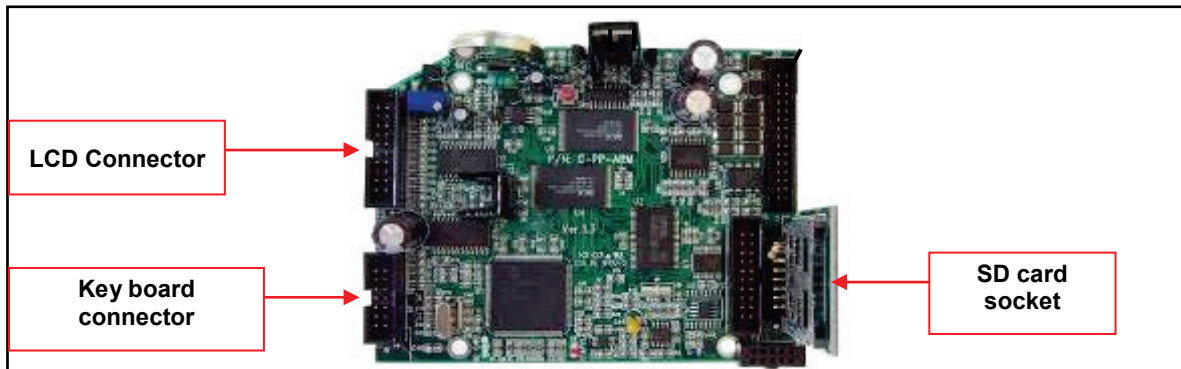

18.2.3 Power Supply



- AC Power Supply
 - ◆ 230/115 VAC ($\pm 10\%$)
- Protection
 - ◆ Thermal fuse
 - ◆ Current detector: short circuit detection
- Power Consumption
 - ◆ Whole system Display ON with all relays turned Off – 450 mA.
 - ◆ Whole system Display OFF with all relays turned Off – 370 mA.
 - ◆ Each relay turned ON – adds 50 mA.
 - ◆ Each Relay/IO card added/removed – adds/removes 10 mA.

TECHNICAL SPECIFICATIONS

18.2.3.1 Power Supply Circuit Drawing

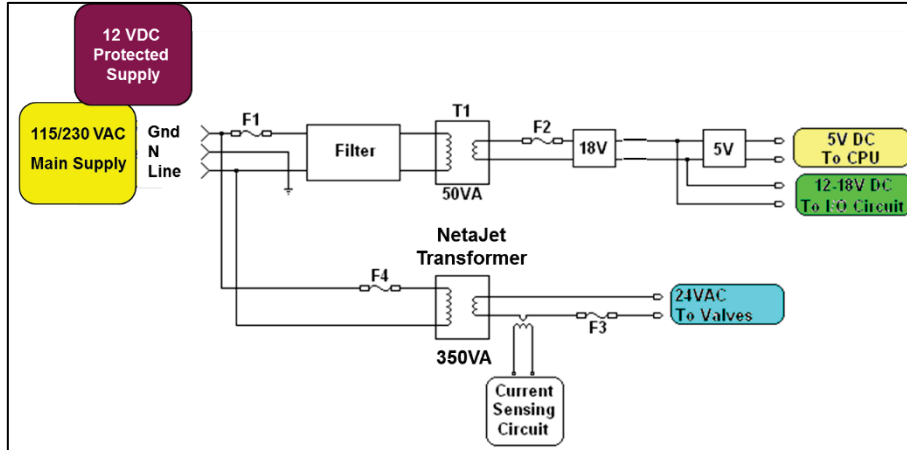

18.2.3.2 Power Supply Fuse Protection

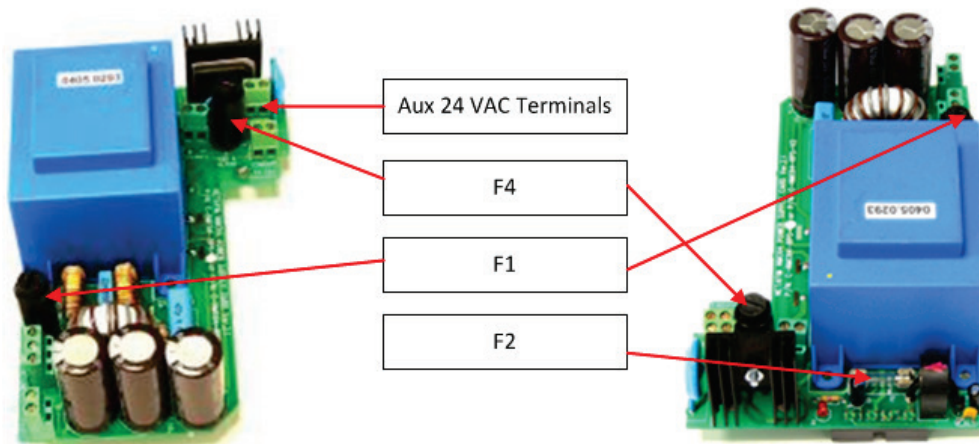

Location	Designation	Type	Style	Rating	Reaction Time	Dimensions
NMC-PRO Power Supply, Main Transformer T1	F1	Tubular Glass	M205	1.0 Amp	Slow Blow (T)	20mm x 5mm
NMC-PRO Power Supply, CPU & I/O Circuit	F2	Tubular Glass	M205	4.0 Amp	Slow Blow (T)	20mm x 5mm
*NMC-PRO Power Supply, 24VAC Output Circuit	F3	Thermal		9.0 Amp	Thermal	
.NMC-PRO Power Supply, Output NetaJet Trans	F4	Tubular Glass	M205	1.25 Amp	Slow Blow (T)	20mm x 5mm

* Back side of power supply card

18.2.3.3 Output

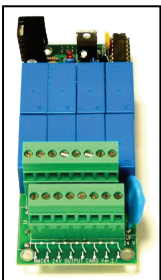

- 24 VAC / output card
- 8 x D.O. AC Relay
- Output rating = 5 Amps
- Single output changing rate = 0.4 Sec

TECHNICAL SPECIFICATIONS

SingleNet License Key



- Communication protocol with SingleNet interface

18.2.4 Digital Input

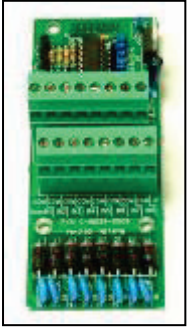

- 8 x D.I. Inputs
- Dry contact input (5V/2mAmp)
- Maximum pulse rate 50pulse/sec (<50 Hz)

18.2.5 Analog Input

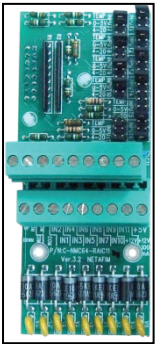

- Inputs 1 – 10: Temperature (NTC 30K Ω), 0-5VDC (Radiation, Relative Humidity, Pressure...), 4-20mA (EC, pH, Pressure...)
- Input 11: Wind direction (Potentiometer), Temperature (NTC 30K Ω), 0-5VDC (Radiation, Relative Humidity, Pressure...), 4-20mA (EC, pH, Pressure...)

Common Analog Sensor Specifications

Sensor	Measured Values	Input Range
Temperature – RTS-s	-20°C to 50°C/ -4°F to 122°F	30kOhm
EC	0 to 10mS (old transmitters used 20 mS)	4 – 20mA
pH	0 - 14	4 – 20mA
RH – RHS-10	0 – 100%	0 – 3 VDC
WD - Davis	0 - 360°	0 – 20kOhm
Pressure	Up to 10bar (145 PSI)	0 – 5 VDC
Radiation	0 – 1800 w/m ²	0 – 5 VDC

18.2.6 Analog Output



- Four outputs
- 4 – 20 mA output
- 24 VAC power supply

19 APPENDIX F - MAIN MENU TREE

Program	Manual	Alarm	History	Test	Setup	Configuration	Installation
Irrigation	Irrigation Pause	Alarm Reset	Irrigation Log	Relays	Time & Date	Device Delay Configuration	Device layout
Water Run Time	Start/Stop Program	History	Rad. Sum & Drain Log	Digital Input	System Setup	Pump Station Configuration	Device List
Dosing	Start/Stop Valve	Alarm Definition	Uncompleted Irrigation	Analog Input	Temp Calibration	Valve Configuration	Digital Input
External Condition	Filter Flushing	Alarm Setting	Uncompleted Programs	Temperature	Humidity Calibration	Valve Flow Configuration	Analog Input 1
Agitator		EC/pH Alarm Setting	Daily Irrigation	Humidity	EC/pH Calibration	Water Meter	Analog Input 2
Selector		EC/pH Alarm Setting	Irrigation Accumulation	Hardware Checklist	Pressure Calibration	Dosing Channel Configuration	Hardware Checklist
Filter Flushing		SMS Subscription	Water & Auxiliary Meter Accumulation		Weather Station Calibration	Dosing Configuration	
Cooling			Accumulation Reset		Sensor Calibration	EC Pre-Control Configuration	
Misting			Filters		Write to Data Plug	Drainage Configuration	
Water Heating			Cooling		Read from Calibration	System Pressure Configuration	
					Edit SMS Phonebook	Radiation Configuration	
					SMS Setup	Pressure Sensor Range Definition	
					SMS Personal Message	Cooling Configuration	
						Misting Configuration	

20 WARRANTY

Controller:

Netafim warrants the electronic components of the NMC-Pro Controller on to be free of defects in materials or workmanship for **1 (one)** year from the date of purchase by end user. If a defect is discovered during the applicable warranty period, Netafim will repair or replace, at its option, the product or the defective part.

Note: lightning and surge damages are not covered by warranty.

Date of

Customer's representative:

Netafim's representative:

Name:

Name:

Signature

Signature
