



LANDSCAPE & TURF PRODUCT CATALOG



DRIP IRRIGATION AND WATER
CONSERVATION PRODUCTS



FROM PIONEERING DRIP IRRIGATION FOR AGRICULTURE, TO INNOVATIVE WATER CONSERVING SOLUTIONS IN LANDSCAPE IRRIGATION

First founded by farmers and agronomists in 1965, who recognized drip irrigation as a solution to one of the world's most urgent problems - lack of quality water for food production - Netafim has grown today to become the recognized global leader in the development of low-volume, drip irrigation solutions for a diverse range of applications.

As a pioneer in developing water-conserving irrigation technologies for the world's agriculture community, Netafim continues to leverage its five decades of innovation to provide today's landscape professionals with comprehensive

solutions for efficient and effective irrigation even in the most challenging residential and commercial landscapes. A complete line of technologically advanced, environmentally sound, drip irrigation and water conservation products deliver water savings, low maintenance and worry-free operation.

Recognizing the evolving needs of a diverse and dynamic landscape industry, Netafim addresses the challenges of modern landscapes through innovative products, education, training and research. Together, we can create sustainable landscapes and grow more with less.

TABLE OF CONTENTS

DRIPLINES

Typical Design Layouts	2
Sizing of Headers	6
Soil Types and Slopes.....	7
General Guidelines	8
Techline® Copper.....	9
Techline® HCVXR-RW and RWP	11
Techline® CV XR.....	13
Techline® CV.....	15
Techline® DL.....	17
Techline® RW and RWP.....	19
Techline® EZ.....	21
12mm & 17mm Fittings.....	23
TechLock Fittings.....	24
Installation Tools	24
Air/Vacuum Relief Air Vents.....	25
Combination Air Vents.....	25
Automatic Flush Valves.....	26
In-Line Check Valve	26
Operation/Pressure Indicator Stakes.....	27

CONTROL ZONE KITS

Low Volume Control Zone Kits.....	28
1" Control Zone	30

REGULATING

Pressure Regulators	31
---------------------------	----

VALVES

Series 80 Nylon Valves.....	33
Iron, Nylon and PVC Valves	35

FILTERS

Manual Disc Filters.....	37
Manual Screen Filters.....	39
2" Compact LP Disc-Kleen Filter.....	40
2" and 3" LP Disc-Kleen Filter	42
Apollo Disc-Kleen Filter	44

WATER METERS

Hydrometers.....	46
Octave Ultrasonic Water Meters.....	48
Water Meters.....	50

POINT SOURCE COMPONENTS

Point Source Design.....	54
Self-Piercing Emitters	55
Techflow Emitters	56
BD and WP Emitters.....	57
NetBow	58
Dr. Zip.....	59
Polyethylene Tubing.....	60
Micro-Tubing	61
Micro-Tube Fittings	62

DESIGN INFORMATION

Dripline Calculations.....	63
Application Rates.....	64
Friction Loss.....	66
Web Resources.....	69
Warranty Information.....	70

TYPICAL LAYOUTS

ON-SURFACE DESIGN

For Use with Techline® Dripline On-Surface Designs (On Top of Soil, Covered with Mulch).

LOW VOLUME CONTROL ZONE KIT

For easy installation, use Netafim's Low Volume Control Zone Kits which include a pre-assembled valve, filter and pressure regulator.

TECHLINE

- Start rows of Techline 2" from hardscapes and 4" from softscapes.
- Flow per zone not to exceed 5 GPM.

OPERATION FLAG

Flag raises to indicate system is operating.

- Flag position down: closed
- Flag position halfway: 7 psi
- Flag position upright: 10 psi or higher
- Use Mister Indicator with Techline CV and HCVXR applications

STAPLES

- Use one staple for:
- Every 3' of Techline in sand, every 4' in loam and every 5' in clay.
 - Use two staples over each tee, elbow or cross.
 - Recommend use of a U-shaped staple that is less likely to pinch the dripline.

MANUAL FLUSH VALVE

- Use one manual flush valve for every 15 GPM of zone flow.
- Position as near as possible to the halfway point of the loop.
 - Install in an area where flushing about one gallon of water will not cause flooding.
- For Techline Copper, CV XR and CV, use a manual flush valve. For Techline DL, EZ and RW, use an automatic flush valve and an air/vacuum relief air vent.

OPTIONAL COMPONENTS

CONTINUOUS ACTING AIR VENT

Place before water meter. Automatic continuous acting mini air vent models available in 1/2" and 3/4" sizes, up to 150 psi.

MASTER VALVE

WATER METER

Water Meter used to measure water usage for irrigation system. Plastic version available in 3/4" and 1" sizes. Metal version available in 3/4" to 6" sizes.

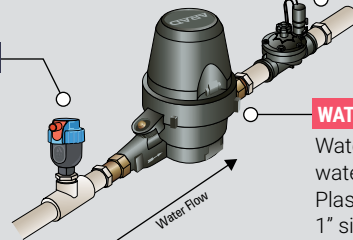

TYPICAL LAYOUTS

SUBSURFACE DESIGN

For Use with Techline® Dripline Designs. Bury Driplines Evenly Throughout the Zone from 4" to 6" Deep or on-surface under Mulch.

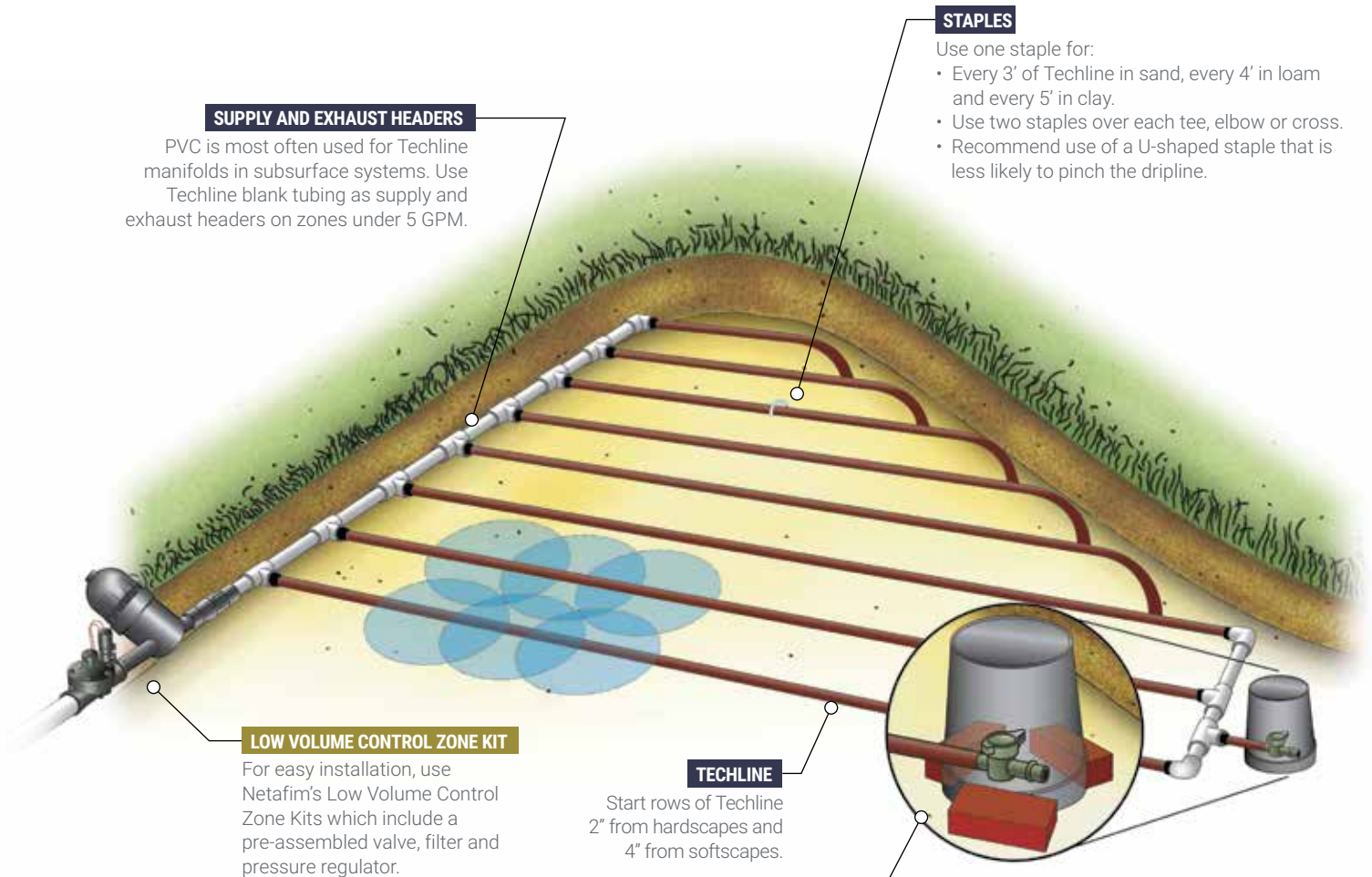

SUPPLY AND EXHAUST HEADERS

PVC is most often used for Techline manifolds in subsurface systems. Use Techline blank tubing as supply and exhaust headers on zones under 5 GPM.

STAPLES

- Use one staple for:
- Every 3' of Techline in sand, every 4' in loam and every 5' in clay.
 - Use two staples over each tee, elbow or cross.
 - Recommend use of a U-shaped staple that is less likely to pinch the dripline.

LOW VOLUME CONTROL ZONE KIT

For easy installation, use Netafim's Low Volume Control Zone Kits which include a pre-assembled valve, filter and pressure regulator.

TECHLINE

Start rows of Techline 2" from hardscapes and 4" from softscapes.

MANUAL FLUSH VALVE

- Normally placed along exhaust header or at the point farthest away from the source.
- Install in a valve box with gravel sump.

NOTES:

- Add an automatic flush valve when using Techline DL, EZ or RW.
- Add an air relief valve at the highest point in the system when using Techline DL, EZ or RW.

OPTIONAL COMPONENTS

CONTINUOUS ACTING AIR VENT

Place before water meter. Automatic continuous acting mini air vent models available in 1/2" and 3/4" sizes, up to 150 psi.

MASTER VALVE

WATER METER

Water Meter used to measure water usage for irrigation system. Plastic version available in 3/4" and 1" sizes. Metal version available in 3/4" to 6" sizes.

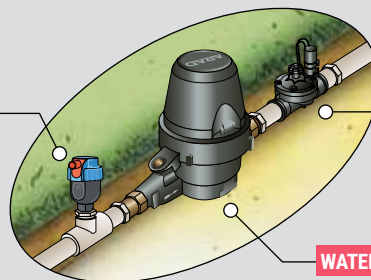

TYPICAL LAYOUTS

SUBSURFACE DESIGN

For Use with Techline® Dripline Designs. Bury Driplines Evenly Throughout the Zone from 4" to 6" Deep.

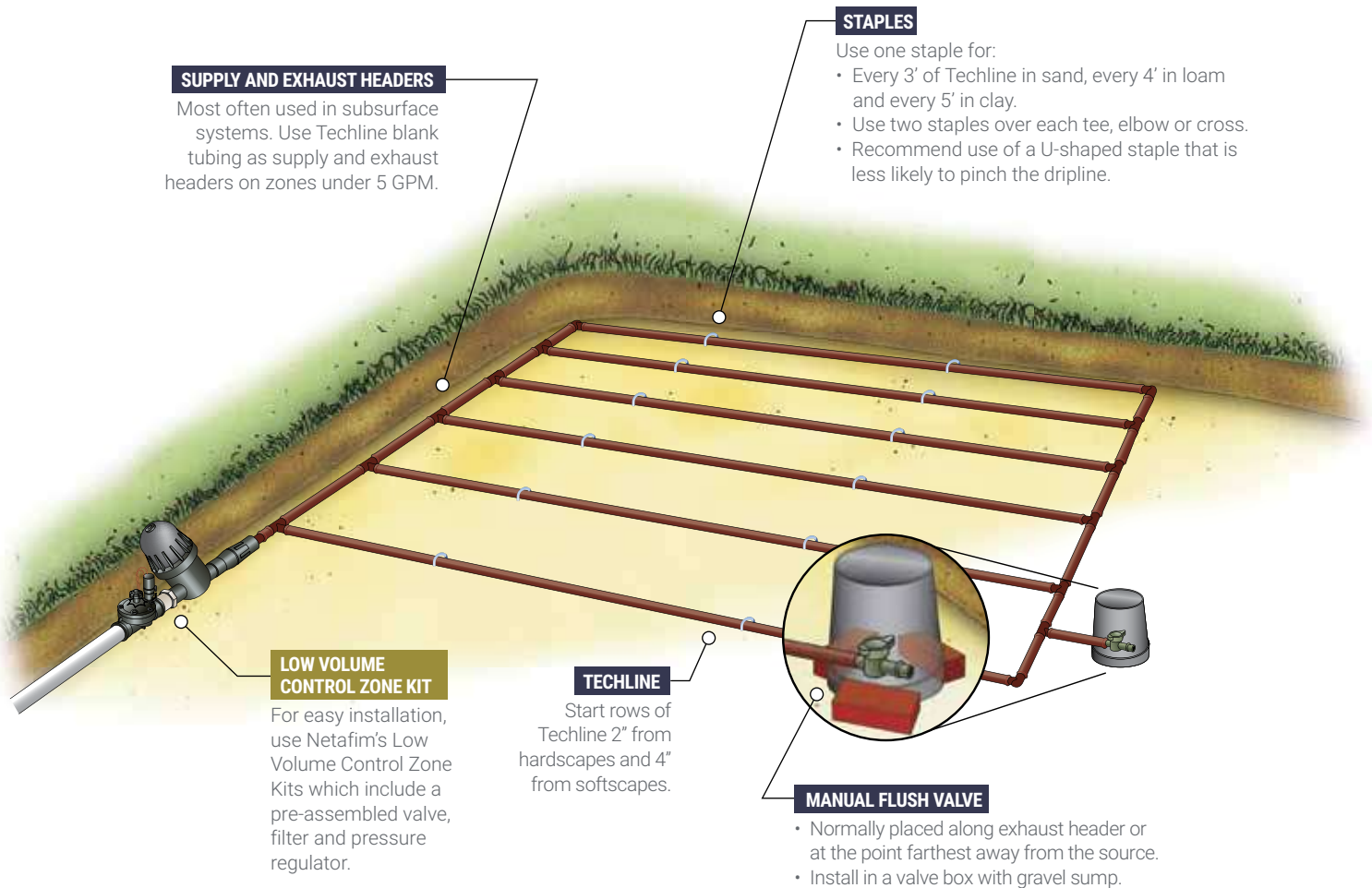

NOTES:

- Add an automatic flush valve when using Techline DL, EZ or RW.
- Add an air relief valve at the highest point in the system when using Techline DL, EZ or RW.



Netafim offers comprehensive design details, installation information and a dripline calculator on our website, www.netafimusa.com

SUBSURFACE/ON-SURFACE DESIGN

CONTOURS

Driplines provide a flexible solution for irrigating around contoured areas and around confined planters or shrubs.

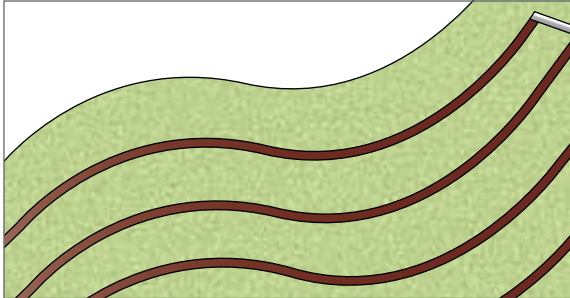

LATERAL PLACEMENT

Place laterals 6" from any hardscape or from the outside of uncontained landscapes. Place laterals perpendicular to (across) slopes, if any.

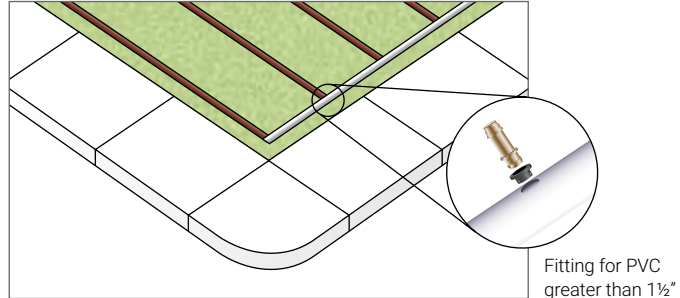

CLOSED LOOP SYSTEMS:

CENTER FEED

For Techline DL, EZ, or RW system applications in medians or island use center feed configuration for long narrow areas.

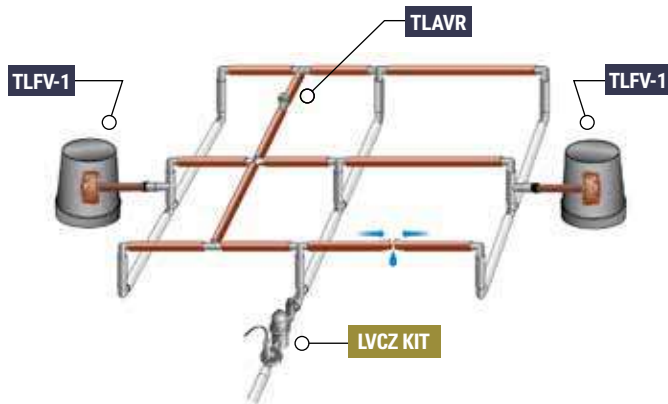

END FEED

For Techline Copper, CV XR, or CV layouts. End feed configurations are generally used for short or medium length installations.

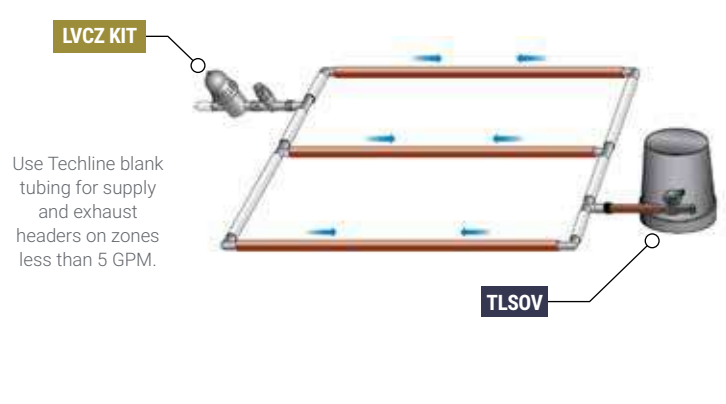

TYPICAL LAYOUTS

TREE RING LAYOUT

For Techline® Techline Copper, CV XR, and CV

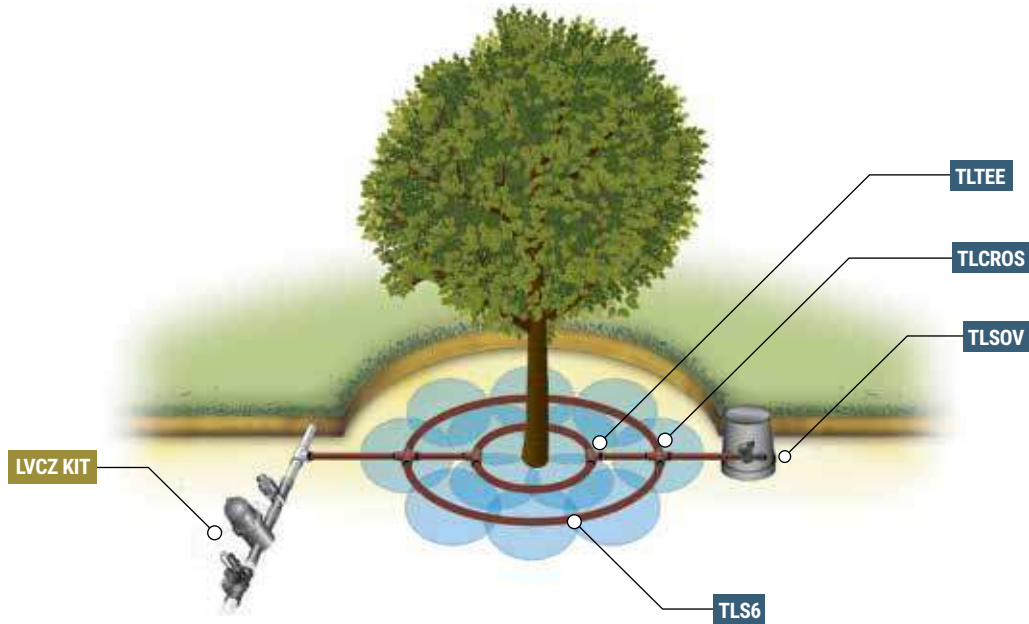

SIZING OF HEADERS

SUPPLY AND EXHAUST HEADERS

PROPER SIZING OF SUPPLY AND EXHAUST HEADERS

(17mm Techline Dripline)

TOTAL ZONE FLOW	PIPE SIZE
UP TO 5 GPM	17mm TECHLINE TUBING OR ½" SCH 40 PVC OR ½" POLY TUBING
5.1 TO 8 GPM	¾" SCH 40 PVC OR ¾" POLY TUBING
8.1 TO 13 GPM	1" SCH 40 PVC OR 1" POLY TUBING
13.1 TO 22 GPM	1 ¼" SCH 40 PVC OR 1 ¼" POLY TUBING
22.1 TO 31 GPM	1 ½" SCH 40 PVC OR 1 ½" POLY TUBING

TOTAL ZONE FLOW	PIPE SIZE
UP TO 6 GPM	½" CLASS 315 PVC
6.1 TO 10 GPM	¾" CLASS 200 PVC
10.1 TO 17 GPM	1" CLASS 200 PVC
17.1 TO 27 GPM	1 ¼" CLASS 200 PVC
27.1 TO 35 GPM	1 ½" CLASS 200 PVC

5 feet per second velocity

NOTE: A 45 psi pressure regulator is recommended to obtain maximum run lengths and maximum zone size when installing 17mm Techline driplines.

SOIL TYPES AND SLOPES

Determining the Proper Emitter to Use is Based Primarily on the Soil Type and Slope.

MAXIMUM PRECIPITATION RATES (Inches per Hour)

		0% TO 5% SLOPE		5% TO 8% SLOPE		8% TO 12% SLOPE		12% TO 20% SLOPE	
		COVERED	BARE	COVERED	BARE	COVERED	BARE	COVERED	BARE
SOIL TEXTURE	COARSE SANDY SOIL	2.00	2.00	2.00	1.50	1.50	1.00	1.00	1.00
	COARSE SANDY SOIL OVER COMPACT SUBSOIL	1.75	1.50	1.25	1.00	1.00	0.75	0.75	0.40
	LIGHT SANDY SOIL	1.75	1.00	1.25	0.80	1.00	0.60	0.75	0.40
	LIGHT SANDY SOIL OVER COMPACT SUBSOIL	1.25	0.75	1.00	0.50	0.75	0.40	0.50	0.30
	UNIFORM SILT LOAM	1.00	0.50	0.80	0.40	0.60	0.30	0.40	0.20
	SILT LOAM OVER COMPACT SUBSOIL	0.60	0.30	0.50	0.25	0.40	0.15	0.30	0.10
	HEAVY CLAY / CLAY LOAM	0.20	0.15	0.15	0.10	0.12	0.08	0.10	0.06

Note: The above average values are for reference purposes. Data may vary with respect to actual soil and site conditions. Data from USDA.

The Maximum Precipitation Rates Chart from the U.S. Department of Agriculture shows the ability of various soils to absorb water. This information is important because it is the best way to show how different soils manage water. In the case of Coarse Sandy Soil on a 0 to 5% Slope, it can absorb 2.00" of water if covered with vegetation. Conversely, a heavy clay/clay loam soil can only accept about 0.20". This means that sandy soil does not hold water as well as tighter soils. It also means that sandy soil will not radiate the water as far laterally and upward as a tighter soil. As such, care needs to be taken when deciding what emitter flow rate to use and how far apart the emitters can be from each other. And as the slope increases, this takes on even greater importance.

SLOPES AND BERMS

Techline Copper, CV XR, and CV emitters have a built-in check valve. This allows Techline Copper to hold back up to a 8.3', Techline CV and CV XR up to 4.6' column of water. As such, designing Techline Copper, CV XR, and CV on slopes and berms is very easy.

- Techline Copper, CV XR, and CV should be installed perpendicular to (across) slopes.
- In the upper 2/3 of the slope, space Techline Copper, CV XR, and CV per General Guidelines tables.
- In the lower 1/3 of the slope, increase the distance between rows by 25%.
- For every 4.6' elevation change, when using Techline CV or CV XR:
 - Split the slope into separate zones, or
 - Install a Netafim in-line check valve (TLCV050M1).
- For every 8.3' elevation change, when using Techline Copper:
 - Split the slope into separate zones, or
 - Install a Netafim in-line check valve (TLCV050M1).

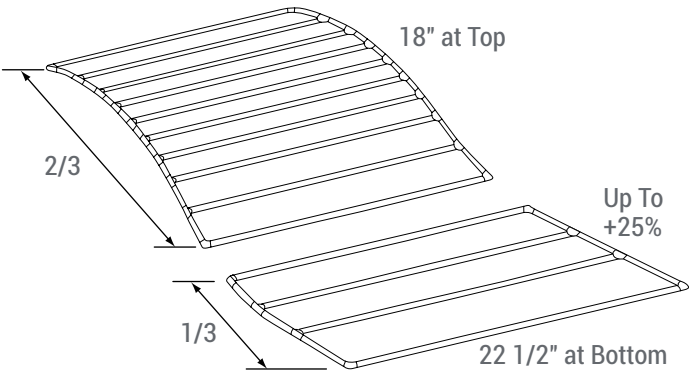

GENERAL GUIDELINES

TECHLINE® COPPER HCVXR - RW/RWP GENERAL GUIDELINES

SOIL	TURF									SHRUB & GROUNDCOVER								
	CLAY			LOAM			SANDY / COARSE			CLAY			LOAM			SANDY / COARSE		
EMITTER FLOW	0.33 GPH			0.53 GPH			0.77 GPH			0.33 GPH			0.53 GPH			0.77 GPH		
EMITTER SPACING	18"			12"			12"			18"			18"			12"		
LATERAL (ROW) SPACING	18"	20"	22"	12"	18"	20"	12"	14"	16"	18"	21"	24"	18"	21"	24"	16"	18"	20"
BURIAL DEPTH	Bury evenly throughout the zone from 4" to 6"									On-surface or bury evenly throughout the zone to a maximum of 6"								
APPLICATION RATE (INCHES/HOUR)	0.24	0.21	0.19	0.85	0.56	0.51	1.23	1.05	0.92	0.24	0.20	0.18	0.38	0.32	0.28	0.92	0.82	0.74
TIME TO APPLY ¼" OF WATER (MINUTES)	64	71	78	18	27	30	12	14	16	64	74	85	40	46	53	16	18	20

Following these maximum spacing guidelines, emitter flow selection can be increased if desired by the designer.

TECHLINE® CV, CV XR, DL & EZ GENERAL GUIDELINES

SOIL	TURF												SHRUB & GROUNDCOVER											
	CLAY			LOAM			SANDY			COARSE			CLAY		LOAM		SANDY		COARSE					
EMITTER FLOW	0.26 GPH			0.42 GPH			0.61 GPH			0.92 GPH			0.26 GPH		0.42 GPH		0.61 GPH		0.92 GPH					
EMITTER SPACING	18"			12"			12"			12"			18"		18"		12"		12"					
LATERAL (ROW) SPACING	18"	20"	22"	12"	18"	20"	12"	14"	16"	12"	14"	16"	18"	21"	24"	18"	21"	24"	16"	18"	20"	16"	18"	20"
BURIAL DEPTH	Bury evenly throughout the zone from 4" to 6"												On-surface or bury evenly throughout the zone to a maximum of 6"											
APPLICATION RATE (INCHES/HOUR)	0.19	0.17	0.15	0.64	0.55	0.43	0.98	0.84	0.65	1.48	1.27	1.11	0.19	0.16	0.14	0.30	0.26	0.23	0.73	0.65	0.59	1.11	0.99	0.89
TIME TO APPLY ¼" OF WATER (MINUTES)	80	89	97	23	27	35	15	18	23	10	12	13	80	93	106	50	58	66	20	23	26	13	15	17

Following these maximum spacing guidelines, emitter flow selection can be increased if desired by the designer.

TECHLINE® COPPER

17mm DRIPLINE

The Highest Performing Dripline in the Industry.



FEATURES & BENEFITS

CHECK VALVE

High check valve holds back 8.3' of water for distribution uniformity.

ANTI-SIPHON

Prevents debris from entering the emitter outlet at system shut-down.

PRESSURE COMPENSATING

Delivers precise, equal amounts of water over a broad pressure range.

LARGE AND EFFECTIVE FILTER AREA

Prevents penetration of coarse particles inside flow path. Superb clog resistance for efficient irrigation.

CONTINUOUS SELF FLUSHING EMITTER

Flushes debris as it's detected.

ONE PIECE DRIPLINE CONSTRUCTION

Reliable, easy installation.

FLEXIBLE UV RESISTANT TUBING

Bending radius of 7" adapts to any planting area shape.

LASER ETCHING

Model number laser etched on dripline.

MORE PROTECTION AGAINST CLOGGING

The large surface area of the filter increases longevity and prevents dirt particles from settling in the dripper.

17 YEAR WARRANTY*

Free of emitter plugging due to root intrusion from the date of original delivery.

*See Warranty Information on page 70.

APPLICATIONS

- Subsurface or on-surface Turf, shrubs, trees and flowers
- Sports turf, tennis courts, golf courses
- Slopes
- Curved, angular or narrow planting areas
- High traffic/high liability areas
- Areas subject to vandalism
- At-grade windows
- Green walls, green roofs
- Raised planters

SPECIFICATIONS

- Emitter flows: 0.33, 0.53, 0.77
- Emitter spacings: 12", 18", 24" (24" spacing available on 1,000 coils only)
- Maximum system pressure: 58 psi
- Minimum pressure: 21.8 psi
- Tubing diameter: 0.66" OD; 0.56" ID, 0.05" wall
- Coil lengths: 100', 250', 500', 1,000'
- Recommended filtration: 120 mesh
- Diaphragm: molded silicon

RECYCLED CONTENT

Techline Copper qualifies for LEED credit 4.2 as it contains a minimum of 20% polyethylene post-consumer recycled material.



TECHLINE COPPER
MADE WITH
POST CONSUMER
RECYCLED MATERIAL



QUALIFIES
FOR USE ON
LEED PROJECTS

WIDE COPPER STRIPE SHIELDS AGAINST ROOT INTRUSION

- Wide stripe design makes it easy to identify the dripline as Techline Copper
- Embedded Cupron® provides a layer of defense against root intrusion
- Cupron® copper oxide (Cu₂O) technology will not wash out, wear off or leach out. Remaining effective throughout the life of the product
- Cupron® copper oxide is approved for use by the EPA ensuring peace of mind

POWER OF CUPRON® COPPER OXIDE ANTIMICROBIAL TECHNOLOGY

Copper is used in many industries for its antimicrobial properties and is recognized by the United States Environmental Protection Agency (US EPA) as the first antimicrobial metal. It is an essential nutrient for humans and bacteria, but in specific concentrations, it can serve as an antimicrobial agent.

Cupron's® proprietary technology is impregnated at specific concentrations to our patent-pending process ensuring it remains effective throughout the life of the product.

FLOW PER 100 FEET

EMITTER SPACING	0.33 EMITTER		0.53 EMITTER		0.77 EMITTER	
	GPH	GPM	GPH	GPM	GPH	GPM
12"	33.0	0.55	53.0	0.88	77.0	1.28
18"	22.0	0.37	35.3	0.59	51.3	0.86
24"	16.5	0.28	26.5	0.44	38.5	0.64

MAXIMUM LENGTH OF A SINGLE LATERAL (FEET)

EMITTER SPACING	12"			18"			24"	
	0.33	0.53	0.77	0.33	0.53	0.77	0.77	
INLET PRESSURE	25 psi	237	173	136	335	246	192	244
	30 psi	327	240	187	464	341	266	338
	35 psi	385	282	221	546	401	314	400
	40 psi	429	315	247	611	449	351	446
	45 psi	467	342	268	663	488	381	486
	50 psi	499	366	287	710	521	408	520
	55 psi	528	387	303	752	552	432	550
	60 psi	554	406	318	788	579	453	578

Exterior Features Inhibiting Root Growth

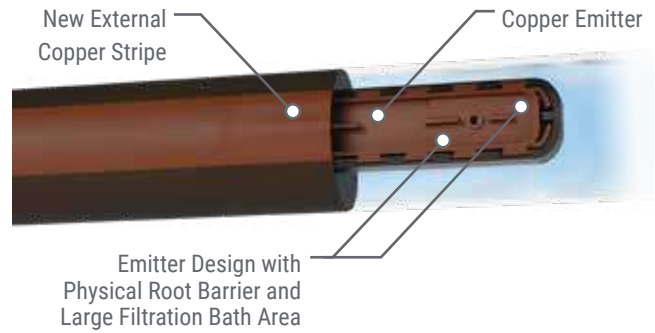

Interior Mechanisms Preventing System Clogging

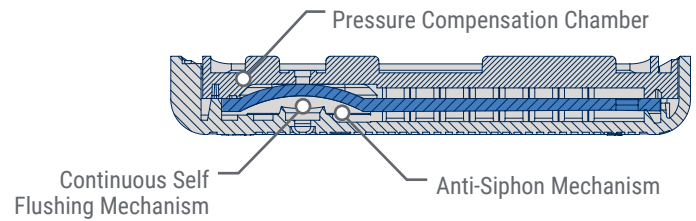

FLOW RATE VS. PRESSURE

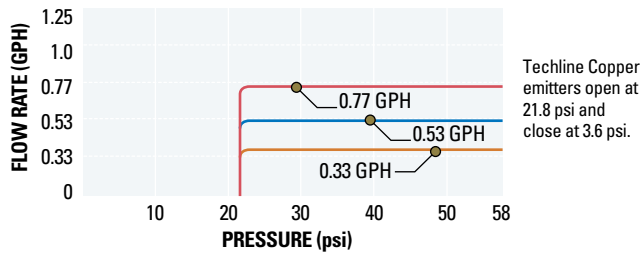

SPECIFYING & ORDERING INFORMATION

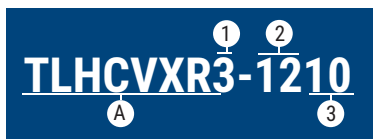

SAMPLE MODEL NUMBER

A Techline HCVXR = TLHCVXR Dripline

1 **EMITTER FLOW RATE**
 0.33 GPH = **3**
 0.53 GPH = **5**
 0.77 GPH = **7**

2 **EMITTER SPACING**
 12" = **12**
 18" = **18**
 24" = **24**

3 **COIL LENGTH**
 100' = **01**
 250' = **025**
 500' = **05**
 1,000' = **10**

ORDERING INFORMATION

FLOW RATE	FLOW CODE	EMITTER SPACING	COIL LENGTH	*MODEL NUMBER	
0.33	3	12"	100'	TLHCVXR X -1201	
			250'	TLHCVXR X -12025	
			500'	TLHCVXR X -1205	
0.53	5	12"	1,000'	TLHCVXR X -1210	
			18"	100'	TLHCVXR X -1801
				250'	TLHCVXR X -18025
500'	TLHCVXR X -1805				
0.77	7	18"	1,000'	TLHCVXR X -1810	
			24"	1,000'	TLHCVXR X -2410

BLANK TUBING

COIL LENGTH	MODEL NUMBER
100'	TLHCVXR-001
250'	TLHCVXR-0025
500'	TLHCVXR-005
1,000'	TLHCVXR-010

* Substitute **X** in the Model Number with Flow Code

* See General Guideline on Page 7.

TECHLINE® HCVXR-RW & RWP

17mm DRIPLINE

For Reclaimed Water Use.

APPLICATIONS

- Subsurface or on-surface turf, shrubs, trees and flowers
- Reclaimed (recycled) water use
- For irrigation with non-potable/reclaimed water and soil loading

SPECIFICATIONS

- Emitter flows: 0.33, 0.53, 0.77
- Emitter spacings: 12" and 18"
- Pressure compensation range: 21.8 to 58 psi
- High check valve: holds back 8.3' of water
- Bending radius: 7"
- Maximum recommended system pressure: 58 psi
- Minimum pressure required: 21.8 psi
- Tubing diameter: 0.66" OD; 0.56" ID, 0.050" wall
- HCVXR-RW coil lengths: 500' and 1,000'
- HCVXR-RWP coil length: 500'
- Recommended minimum filtration: 120 mesh
- Diaphragm: molded silicon
- ISO 9261 Standard Compliance

FEATURES & BENEFITS

LONG LASTING PROTECTION THROUGHOUT THE LIFE OF THE DRIPLINE

Cupron® copper oxide will not wash off, wear off and does not leach out of the emitter providing superior root intrusion resistance.

PATENTED EMITTER DESIGN WITH PHYSICAL ROOT BARRIER

Offset flow path, extra large bath area and raised outlet prevent root intrusion.

HIGH CHECK VALVE IN EACH EMITTER

The high check valve is great on slopes because it holds back 8.3' of water (elevation change) keeping the dripline charged for even distribution of water with no emitter drainage in low spots.

EMITTER WITH ANTI-SIPHON FEATURE

Emitter outlet is sealed at system shutdown blocking debris from entering the dripline after irrigation.

PRESSURE COMPENSATING WITH CONTINUOUS SELF-FLUSHING

Delivers precise, equal amounts of water over wide pressure range while continuously flushing debris throughout operation.

THREE EMITTER FLOW RATES

Achieve maximum design flexibility with three emitter flow rates - the most options offered in the industry.

17 YEAR WARRANTY

Netafim stands behind Techline HCVXR-RW/RWP with an unprecedented limited warranty for root intrusion. We warrant Techline HCVXR-RW/RWP to be free of emitter plugging due to root intrusion for a period of 17 years* from the date of original delivery.

* Refer to the Warranty Page for more details.



TECHLINE HCVXR-RW



Purple striped dripline



TECHLINE HCVXR-RWP



Solid purple dripline



LASER ETCHING FOR EASY IDENTIFICATION



TECHLINE RW & RWP MADE WITH POST CONSUMER RECYCLED MATERIAL



QUALIFIES FOR USE ON LEED PROJECTS

TECHLINE HCVXR-RW AND RWP ARE DESIGNED FOR RECLAIMED WATER USE ONLY

Reclaimed, reuse or recycled water is municipally-treated, non-potable water deemed appropriate for use in irrigation systems and not wastewater being dispersed into the soil for additional treatment. Please consult your local Water Management District for regulations regarding the type of water being used, and its proper system design. Netafim USA can provide assistance on drip dispersal that uses primary or secondary and tertiary wastewater. Please contact Netafim USA Customer Service for more information.

FLOW PER 100 FEET

EMITTER SPACING	0.33 EMITTER		0.53 EMITTER		0.77 EMITTER	
	GPH	GPM	GPH	GPM	GPH	GPM
12"	33.0	0.55	53.0	0.88	77.0	1.28
18"	22.0	0.37	35.3	0.59	51.3	0.86

FLOW RATE VS. PRESSURE

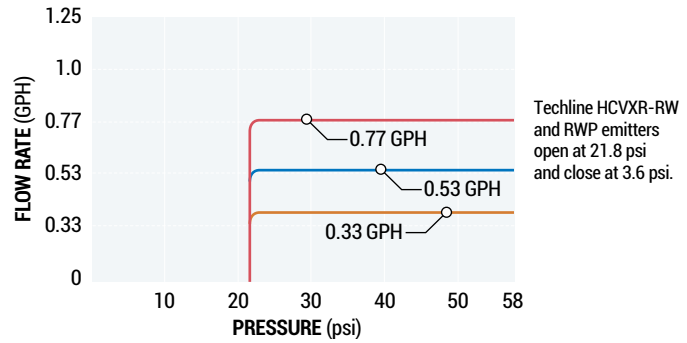

MAXIMUM LENGTH OF A SINGLE LATERAL (FEET)

EMITTER SPACING		12"			18"		
EMITTER FLOW (GPH)		0.33	0.53	0.77	0.33	0.53	0.77
INLET PRESSURE	25 psi	237	173	136	335	246	192
	30 psi	327	240	187	464	341	266
	35 psi	385	282	221	546	401	314
	40 psi	429	315	247	611	449	351
	45 psi	467	342	268	663	488	381
	50 psi	499	366	287	710	521	408
	55 psi	528	387	303	752	552	432
	60 psi	554	406	318	788	579	453

SPECIFYING MODEL NUMBER



SAMPLE MODEL NUMBER

A Techline HCVXR-RW = TLHCVXR-RW Dripline

Techline HCVXR-RWP = TLHCVXR-RWP Dripline

1 **EMITTER FLOW RATE**
 0.33 GPH = 3
 0.53 GPH = 5
 0.77 GPH = 7

2 **EMITTER SPACING**
 12" = 12
 18" = 18
 24" = 24

3 **COIL LENGTH**
 100' = 01
 250' = 025
 500' = 05
 1,000' = 10

ORDERING INFORMATION

FLOW RATE	FLOW CODE	EMITTER SPACING	COIL LENGTH	*MODEL NUMBER	
0.33	3	12"	100'	TLHCVXR X -1201	
			250'	TLHCVXR X -12025	
			500'	TLHCVXR X -1205	
0.53	5	12"	1,000'	TLHCVXR X -1210	
			18"	100'	TLHCVXR X -1801
				250'	TLHCVXR X -18025
				500'	TLHCVXR X -1805
0.77	7	18"	1,000'	TLHCVXR X -1810	
			24"	1,000'	TLHCVXR X -2410
				11	

BLANK TUBING

COIL LENGTH	MODEL NUMBER
500'	TLHCVXR-RW005
500'	TLHCVXR-RWP005
1,000'	TLHCVXR-RW010

* Substitute **X** in the Model Number with Flow Code

* See General Guideline on Page 7.

Enhanced with Copper for Long Lasting Protection.

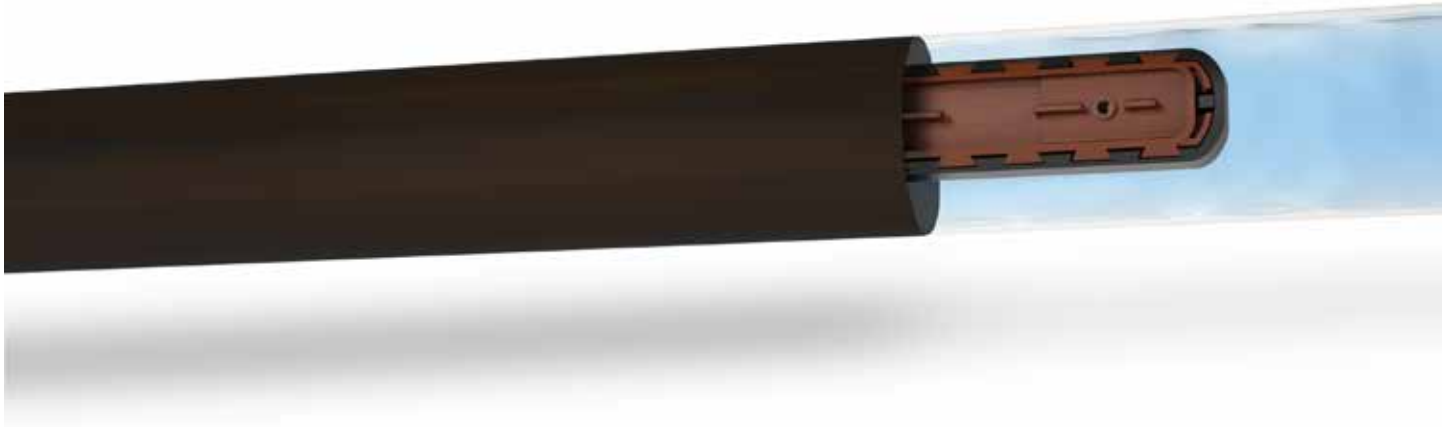

APPLICATIONS

- Subsurface or on-surface turf, shrubs, trees and flowers
- Sports turf, tennis courts, golf courses
- Slopes
- Longer lateral runs
- Curved, angular or narrow planting areas
- High traffic/high liability areas
- Areas subject to vandalism
- High wind areas
- At-grade windows
- Green walls, green roofs
- Raised planters

SPECIFICATIONS

- Broad choice of emitter flow rates: 0.42, 0.61, 0.92 GPH.
- Emitter spacings: 12" and 18".
- Pressure compensated range: 14.5 - 58 psi.
- Check Valve (CNL): Emitters open at 14.5 psi and shut off at 2 psi to hold back 4.6' of water.
- Recommended filtration: -120 mesh.
- Coil length: 250' & 1000'.

FEATURES & BENEFITS

CUPRON ENHANCED DRIPPER

Copper Oxide is embedded into the emitter labyrinth and is an effective deterrent against root intrusion without any reliance on chemicals. Cupron Copper oxide provides long lasting protection due to non migrating active ingredients, lasting the life of the Techline.

CHECK VALVE (CNL)

All emitters turn on and off at the same time, maximizing balance of application. Holds back up to 4.6' of water. No low emitter drainage, great on slopes, and delivers more precise watering.

ANTI-SIPHON MECHANISM

Prevents contaminants from being drawn into the dripper, making it ideal for sub surface applications.

PRESSURE COMPENSATED

Precise and equal amounts of water delivered over a broad pressure range ensuring 100% uniformity of water and nutrient distribution along the laterals.

PHYSICAL ROOT BARRIER

Offset flow path, extra large bath area, and raised outlets provide another level of protection by physically blocking roots from the labyrinth.

CONTINUOUS SELF-FLUSHING MECHANISM

Flushes debris throughout operation, while ensuring constant dripper operation.

LARGE FILTRATION AREA

The Techline™ CV XR Dripper is highly resistant to clogging from poor quality water, thus increasing filtration efficiency.

TURBONET™

TurboNet technology improves dripper performances by widening the tooth pattern, maximizing flow path velocity, allowing contaminants to pass easily through the dripper, virtually eliminating plugging.

17 YEAR WARRANTY*

Free of emitter plugging due to root intrusion from the date of original delivery.

*See Warranty Information on page 70.

FLOW PER 100 FEET

EMITTER SPACING	0.42 EMITTER		0.61 EMITTER		0.92 EMITTER	
	GPH	GPM	GPH	GPM	GPH	GPM
12"	42.3	0.71	60.8	1.01	92.5	1.54
18"	28.2	0.47	40.5	0.68	61.6	1.03

MAXIMUM LENGTH OF A SINGLE LATERAL (FEET)

EMITTER SPACING	12"			18"		
	0.42	0.61	0.92	0.42	0.61	0.92
20 psi	242	190	144	344	270	204
25 psi	302	238	180	429	338	257
35 psi	380	299	227	540	426	323
45 psi	436	343	260	620	489	371
55 psi	480	378	287	684	539	410
60 psi	500	393	298	713	561	426

FLOW RATE VS. PRESSURE

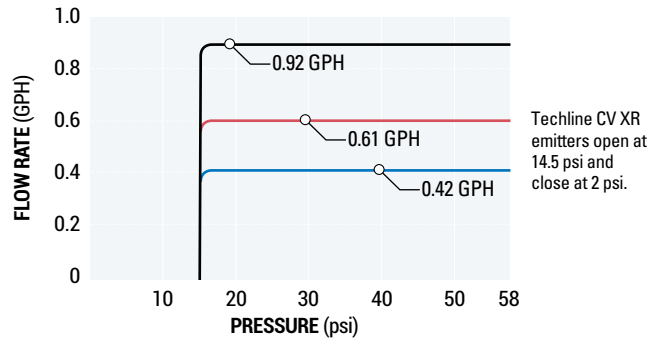

SPECIFYING MODEL NUMBER



SAMPLE MODEL NUMBER

A Techline HC XR Dripline = **TLCVXR**

1 **EMITTER FLOW RATE**
 0.42 GPH = 4
 0.61 GPH = 6
 0.92 GPH = 9

2 **EMITTER SPACING**
 12" = 12
 18" = 18

3 **COIL LENGTH**
 250' = 025
 1,000' = 10

ORDERING INFORMATION

FLOW RATE	EMITTER SPACING	COIL LENGTH	MODEL NUMBER
0.42 GPH	12"	250'	TLCVXR4-12025
		1,000'	TLCVXR4-1210
	18"	250'	TLCVXR4-18025
		1,000'	TLCVXR4-1810
0.61 GPH	12"	250'	TLCVXR6-12025
		1,000'	TLCVXR6-1210
	18"	250'	TLCVXR6-18025
		1,000'	TLCVXR6-1810
0.92 GPH	12"	250'	TLCVXR9-12025
		1,000'	TLCVXR9-1210
	18"	250'	TLCVXR9-18025
		1,000'	TLCVXR9-1810

BLANK TUBING

COIL LENGTH	MODEL NUMBER
250'	TLCVXR0025
1,000'	TLCVXR010

* See General Guideline on Page 7.

Maximum Uniformity in Subsurface and On-surface Including Slopes.

APPLICATIONS

- Subsurface or on-surface turf, shrubs, trees and flowers
- Sports turf, tennis courts, golf courses
- Slopes
- Longer lateral runs
- Curved, angular or narrow planting areas
- High traffic/high liability areas
- Areas subject to vandalism
- High wind areas
- At-grade windows
- Green walls, green roofs
- Raised planters

SPECIFICATIONS

- Broadest choice of emitter flow rates: 0.26, 0.42, 0.61 and 0.92 GPH
- Emitter spacings: 12", 18" and 24" (24" spacing available for 0.61 and 0.92 GPH only)
- Pressure compensation range: 14.5 to 58 psi
- Bending radius: 7"
- Maximum recommended system pressure: 58 psi
- Minimum pressure required: 14.5 psi
- Tubing diameter: 0.66" OD; 0.56" ID; 0.050" wall
- Coil lengths: 100', 250', 500', 1,000'
- Recommended minimum filtration: 120 mesh
- Diaphragm made of silicon
- ISO 9261 Standard Compliance

FEATURES & BENEFITS

2 psi CHECK VALVE IN EACH EMITTER

All emitters turn on and off at the same time, maximizing balance of application. Holds back up to 4.6' of water (elevation change). No low emitter drainage, great on slopes. Delivers more precise watering.

UNIQUE PATENTED EMITTER DESIGN WITH PHYSICAL ROOT BARRIER

Offset flow path, extra large bath area and raised outlet prevent root intrusion without chemical reliance.

PRESSURE COMPENSATING

Precise and equal amounts of water are delivered over a broad pressure range.

CONTINUOUS SELF-FLUSHING EMITTER DESIGN

Flushes debris as it is detected, throughout operation, not just at the beginning or end of a cycle, ensuring uninterrupted emitter operation.

EMITTER WITH ANTI-SIPHON FEATURE

Prevents ingestion of debris into tubing caused by vacuum.

SELF-CONTAINED, ONE-PIECE DRIPLINE CONSTRUCTION

Assures reliable, easy installation.

FLEXIBLE UV RESISTANT TUBING

Adapts to any planting area shape - tubing curves at a 7" radius. For on-surface installations withstands heat and direct sun.

MAKES INSTALLATION QUICKER

Does not require automatic flush valve for on-surface or subsurface installations. Use manual flush valves at exhaust headers.



Exploded View of Techline CV Emitter

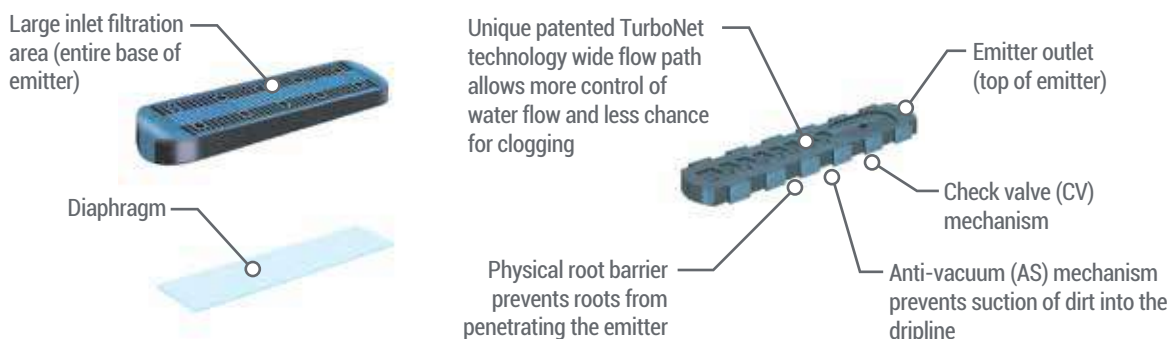

FLOW PER 100 FEET

EMITTER SPACING	0.26 EMITTER		0.42 EMITTER		0.61 EMITTER		0.92 EMITTER	
	GPH	GPM	GPH	GPM	GPH	GPM	GPH	GPM
12"	26.4	0.44	42.3	0.71	60.8	1.01	92.5	1.54
18"	17.6	0.29	28.2	0.47	40.5	0.68	61.6	1.03
24"	-	-	-	-	30.4	0.51	46.2	0.77

FLOW RATE VS. PRESSURE

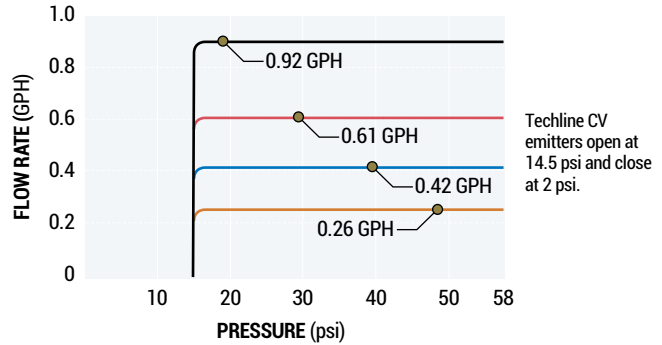

MAXIMUM LENGTH OF A SINGLE LATERAL (FEET)

EMITTER SPACING		12"				18"				24"	
EMITTER FLOW (GPH)		0.26	0.42	0.61	0.92	0.26	0.42	0.61	0.92	0.61	0.92
INLET PRESSURE	20 psi	331	242	190	144	468	344	270	204	342	260
	25 psi	413	302	238	180	584	429	338	257	430	326
	35 psi	518	380	299	227	737	540	426	323	542	412
	45 psi	594	436	343	260	845	620	489	371	622	472
	55 psi	655	480	378	287	932	684	539	410	686	522
	60 psi	681	500	393	298	969	713	561	426	716	544



TECHLINE CALCULATOR
 DOWNLOAD FROM THE APP STORE OR GOOGLE PLAY

SPECIFYING MODEL NUMBER

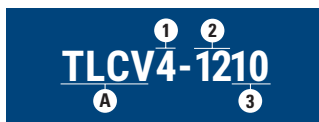

SAMPLE MODEL NUMBER

A Techline CV Dripline = **TLCV**

1 **EMITTER FLOW RATE**
 0.26 GPH = **26**
 0.42 GPH = **4**
 0.61 GPH = **6**
 0.92 GPH = **9**

2 **EMITTER SPACING**
 12" = **12**
 18" = **18**
 24" = **24**

3 **COIL LENGTH**
 100' = **01**
 250' = **025**
 500' = **05**
 1,000' = **10**

ORDERING INFORMATION

FLOW RATE	FLOW CODE	EMITTER SPACING	COIL LENGTH	MODEL NUMBER
0.26	26	12"	100'	TLCV X -1201
			250'	TLCV X -12025
			1,000'	TLCV X -1210
0.42	4	18"	100'	TLCV X -1801
			250'	TLCV X -18025
			1,000'	TLCV X -1810
0.61	6	24"	100'	TLCV X -2401
			250'	TLCV X -24025
			1,000'	TLCV X -2410

BLANK TUBING

COIL LENGTH	MODEL NUMBER
100'	TLCV001
250'	TLCV0025
500'	TLCV005
1,000'	TLCV010

* Substitute **X** in the Model Number with Flow Code

* See General Guideline on Page 7.

Maximum Uniformity in Subsurface and On-surface Including Slopes.

APPLICATIONS

- Subsurface or on-surface turf, shrubs, trees and flowers
- Curved, angular or narrow planting areas
- High traffic/high liability areas
- Areas subject to vandalism
- High wind areas
- Turf, shrubs, trees
- Slopes
- At-grade windows
- Sports turf

SPECIFICATIONS

- Emitter flow rates: 0.26, 0.42, 0.61 and 0.92 GPH
- Emitter spacings: 12", 18" or 24" (24" available in 0.61 and 0.92 GPH only)
- Pressure compensation range: 6 to 58 psi
- Bending radius: 7"
- Maximum recommended system pressure: 58 psi
- Minimum pressure required: 6 psi
- Tubing diameter: 0.66" OD; 0.56" ID; 0.050" wall
- Coil lengths: 100', 250', 500', 1,000'
- Recommended minimum filtration: 120 mesh
- Diaphragm made of silicon
- ISO 9261 Standard Compliance

FEATURES & BENEFITS

THE FIRST ANTI-SIPHON EMITTER IN LANDSCAPE DRIPLINE

Emitter manufactured and successfully used in harsh agricultural applications since 2000. Emitter is pressure compensating and continuous flushing.

EMITTER WITH ANTI-SIPHON FEATURE

Prevents ingestion of debris into tubing caused by vacuum.

SELF-CONTAINED, ONE-PIECE DRIPLINE CONSTRUCTION

Assures reliable, easy installation.

FLEXIBLE UV RESISTANT TUBING

Adapts to any planting area shape - tubing curves at a 7" radius. For on-surface installations withstands heat and direct sun.

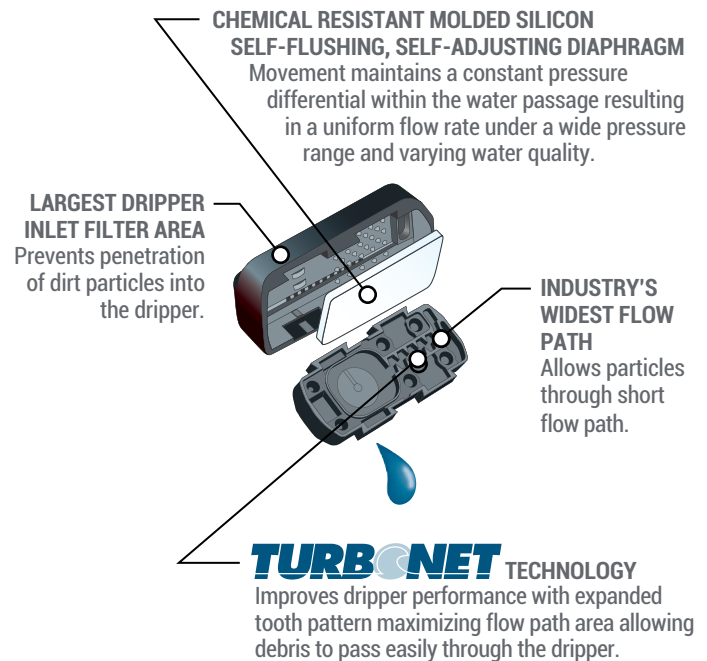

FLOW RATE VS. PRESSURE

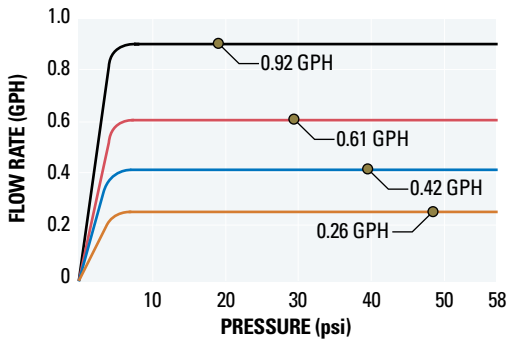

MAXIMUM LENGTH OF A SINGLE LATERAL (FEET)

EMITTER SPACING	12"				18"				24"	
	0.26	0.42	0.61	0.92	0.26	0.42	0.61	0.92	0.61	0.92
10 psi	332	244	192	146	461	338	267	203	332	252
20 psi	512	376	297	225	711	524	413	314	518	394
25 psi	569	418	330	250	792	582	459	350	576	438
35 psi	659	484	382	290	918	675	533	405	670	510
45 psi	730	537	423	321	1,019	750	591	450	742	566
55 psi	790	581	458	348	1,103	812	641	488	804	612
60 psi	818	601	474	360	1,140	840	663	504	832	634

FLOW PER 100 FEET

EMITTER SPACING	0.26 EMITTER		0.42 EMITTER		0.61 EMITTER		0.92 EMITTER	
	GPH	GPM	GPH	GPM	GPH	GPM	GPH	GPM
12"	26.4	0.44	42.3	0.71	60.8	1.01	92.5	1.54
18"	17.6	0.29	28.2	0.47	40.5	0.68	61.6	1.03
24"	-	-	-	-	30.4	0.51	46.2	0.77

SPECIFYING MODEL NUMBER

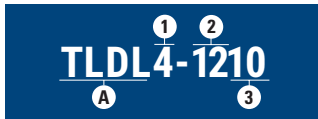

SAMPLE MODEL NUMBER

A Techline DL Dripline = TL4

1 **EMITTER FLOW RATE**
 0.26 GPH = 26
 0.42 GPH = 4
 0.61 GPH = 6
 0.92 GPH = 9

2 **EMITTER SPACING**
 12" = 12
 18" = 18
 24" = 24

3 **COIL LENGTH**
 100' = 01
 250' = 025
 500' = 05
 1,000' = 10

ORDERING INFORMATION

FLOW RATE	FLOW CODE	EMITTER SPACING	COIL LENGTH	*MODEL NUMBER
0.26	26	12"	100'	TL4X-1201
			250'	TL4X-12025
			500'	TL4X-1205
			1,000'	TL4X-1210
0.42	4	18"	100'	TL4X-1801
			250'	TL4X-18025
			500'	TL4X-1805
			1,000'	TL4X-1810
0.61	6	24"	1,000'	TL4X-2410
			1,000'	TL4X-2410

BLANK TUBING

COIL LENGTH	MODEL NUMBER
100'	TL4L-001
250'	TL4L-0025
500'	TL4L-005
1,000'	TL4L-010

* Substitute X in the Model Number with Flow Code

* See General Guideline on Page 7.

FEATURES & BENEFITS

UNIQUE PATENTED EMITTER DESIGN WITH PHYSICAL ROOT BARRIER

Emitters prevent root intrusion without chemical reliance.

PRESSURE COMPENSATING

Precise and equal amounts of water are delivered over a broad pressure range.

CONTINUOUS SELF-FLUSHING EMITTER DESIGN

Flushes debris as it is detected, throughout operation, not just at the beginning or end of a cycle, ensuring uninterrupted emitter operation.

EMITTER WITH ANTI-SIPHON FEATURE

Prevents ingestion of debris into tubing caused by vacuum.

SELF-CONTAINED, ONE-PIECE DRIPLINE CONSTRUCTION

Assures reliable, easy installation.

FLEXIBLE UV RESISTANT TUBING

Adapts to any planting area shape - tubing curves at a 7" radius. For on-surface installations withstands heat and direct sun.

APPLICATIONS

- For subsurface or on-surface irrigation with non-potable/ reclaimed water and soil loading
- Reclaimed (recycled) water use
- For irrigation with non-potable/ reclaimed water and soil loading

SPECIFICATIONS

- Emitter flow rates: 0.26, 0.42, 0.61 and 0.92 GPH
- Emitter spacings: 12", 18" and 24"
- Pressure compensation range: 7 to 58 psi
- Bending radius: 7"
- Maximum recommended system pressure: 58 psi
- Minimum pressure required: 6 psi
- Tubing diameter: 0.66" OD; 0.56" ID; 0.050" wall
- Coil lengths: 250' and 1,000'
- Recommended minimum filtration: 120 mesh
- Diaphragm made of silicon
- ISO 9261 Standard Compliance



TECHLINE RW



Purple striped dripline



TECHLINE RWP



Solid purple dripline



LASER ETCHING
FOR EASY IDENTIFICATION



TECHLINE RW & RWP
MADE WITH POST CONSUMER RECYCLED MATERIAL



QUALIFIES FOR USE ON LEED PROJECTS

TECHLINE RW AND RWP ARE DESIGNED FOR RECLAIMED WATER USE ONLY

Reclaimed, reuse or recycled water is municipally-treated, non-potable water deemed appropriate for use in irrigation systems and not wastewater being dispersed into the soil for additional treatment. Please consult your local Water Management District for regulations regarding the type of water being used, and its proper system design. Netafim USA can provide assistance on drip dispersal that uses primary or secondary and tertiary wastewater. Please contact Netafim USA Customer Service for more information.

FLOW RATE VS. PRESSURE

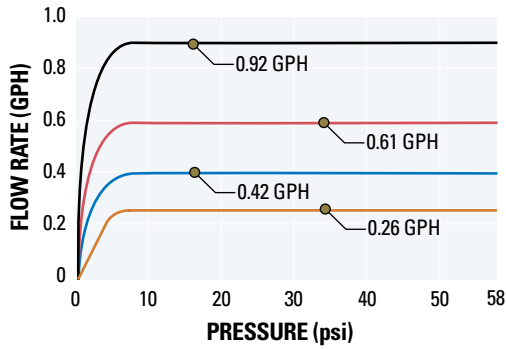

MAXIMUM LENGTH OF A SINGLE LATERAL (FEET)

EMITTER SPACING	12"				18"				24"	
	0.26	0.42	0.61	0.92	0.26	0.42	0.61	0.92	0.61	0.92
10 psi	332	244	192	146	461	338	267	203	332	252
20 psi	512	376	297	225	711	524	413	314	518	394
25 psi	569	418	330	250	792	582	459	350	576	438
35 psi	659	484	382	290	918	675	533	405	670	510
45 psi	730	537	423	321	1,019	750	591	450	742	566
55 psi	790	581	458	348	1,103	812	641	488	804	612
60 psi	818	601	474	360	1,140	840	663	504	832	634

FLOW PER 100 FEET

EMITTER SPACING	0.26 EMITTER		0.42 EMITTER		0.61 EMITTER		0.92 EMITTER	
	GPH	GPM	GPH	GPM	GPH	GPM	GPH	GPM
12"	26.4	0.44	42.3	0.71	60.8	1.01	92.5	1.54
18"	17.6	0.29	28.2	0.47	40.5	0.68	61.6	1.03
24"	-	-	-	-	30.4	0.51	46.2	0.77

SPECIFYING MODEL NUMBER



SAMPLE MODEL NUMBER

A Techline RW Dripline = **TLRW**
Techline RWP Dripline = **TLRWP**

1 **EMITTER FLOW RATE**
0.26 GPH = **26**
0.42 GPH = **4**
0.61 GPH = **6**
0.92 GPH = **9**

2 **EMITTER SPACING**
12" = **12**
18" = **18**
24" = **24**

3 **COIL LENGTH**
250' = **025**
1,000' = **10**

ORDERING INFORMATION

FLOW RATE	FLOW CODE	EMITTER SPACING	COIL LENGTH	*RW MODEL NUMBER	*RWP MODEL NUMBER
0.26	26	12"	100'	TLRW X -1201	TLRWP X -1201
			250'	TLRW X -12025	TLRWP X -12025
			500'	TLRW X -1205	TLRWP X -1205
0.42	4	12"	1,000'	TLRW X -1210	TLRWP X -1210
			100'	TLRW X -1801	TLRWP X -1801
0.61	6	18"	250'	TLRW X -18025	TLRWP X -18025
			500'	TLRW X -1805	TLRWP X -1805
0.92	9	18"	1,000'	TLRW X -1810	TLRWP X -1810
			1,000'	TLRW X -2410	TLRWP X -2410

BLANK TUBING

COIL LENGTH	MODEL NUMBER
250'	TLRW-0025
250'	TLRWP-0025
1,000'	TLRW-010
1,000'	TLRWP-010

* Substitute **X** in the Model Number with Flow Code

* See General Guideline on Page 7.

APPLICATIONS

- Subsurface or on-surface turf, shrubs, trees and flowers
- Bed areas that require shorter lateral lengths
- Areas subject to vandalism
- Planting areas
- Curved, narrow, and angular planting areas
- Rooftop gardens
- Vegetable gardens
- Green walls
- High traffic or high liability areas
- Raised planters

SPECIFICATIONS

- Emitter flow rates: 0.26, 0.42, 0.61 and 0.92 GPH
- Emitter spacings: 6", 12" and 18" (6" available for 0.26 and 0.42 GPH only)
- Uses 12mm Netafim insert fittings or any compression fitting for 0.510" O.D. diameter tubing
- Pressure compensation range: 6 to 58 psi
- Bending radius: 6"
- Maximum recommended system pressure: 58 psi
- Minimum pressure required: 6 psi
- Tubing diameter: 0.510" O.D.; 0.426" I.D.
- Coil lengths: 200', 250', 300', 500', 1,000'
- Recommended minimum filtration: 120 mesh
- Diaphragm made of silicon
- ISO 9261 Standard Compliance

FEATURES & BENEFITS

THE FIRST ANTI-SIPHON EMITTER IN LANDSCAPE DRIPLINE

Emitter manufactured and successfully used in harsh agricultural applications since 2000. Emitter is pressure compensating and continuous flushing.

LESS VISUALLY OBTRUSIVE

12mm diameter tubing is less noticeable in landscape installations.

EMITTER WITH ANTI-SIPHON FEATURE

Prevents ingestion of debris into tubing caused by vacuum.

SELF-CONTAINED, ONE-PIECE DRIPLINE CONSTRUCTION

Assures reliable, easy installation.

FLEXIBLE UV RESISTANT TUBING

Adapts to any planting area shape - tubing curves at a 6" radius. For on-surface installations withstands heat and direct sun.

MORE COST EFFECTIVE IN SMALLER BED AREAS

24% smaller diameter tubing.



**LASER
ETCHING**
FOR EASY
IDENTIFICATION



TECHLINE EZ
MADE WITH
POST CONSUMER
RECYCLED MATERIAL



QUALIFIES
FOR USE ON
LEED PROJECTS

FLOW RATE VS. PRESSURE

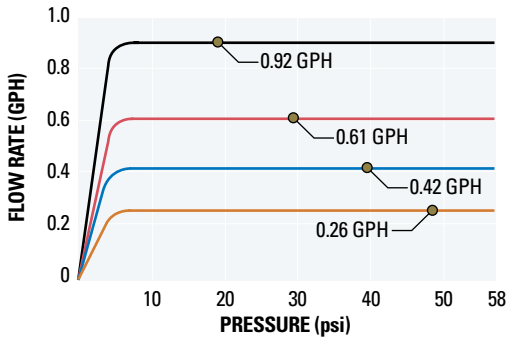

MAXIMUM LENGTH OF A SINGLE LATERAL (FEET)

EMITTER SPACING	6"		12"				18"			
	0.26	0.42	0.26	0.42	0.61	0.92	0.26	0.42	0.61	0.92
10 psi	93	68	173	126	99	75	243	179	140	105
20 psi	143	105	265	194	153	116	374	275	216	164
25 psi	158	116	294	216	170	129	416	305	240	182
35 psi	183	134	340	250	196	149	480	353	278	212
45 psi	202	148	377	276	218	165	533	392	308	234
55 psi	219	160	407	299	235	178	576	423	333	254
60 psi	226	166	421	309	243	184	596	438	345	263

FLOW PER 100 FEET

EMITTER SPACING	0.26 EMITTER		0.42 EMITTER		0.61 EMITTER		0.92 EMITTER	
	GPH	GPM	GPH	GPM	GPH	GPM	GPH	GPM
6"	52.8	0.88	84.0	1.40	Not Standard		Not Standard	
12"	26.4	0.44	42.3	0.71	60.8	1.01	92.5	1.54
18"	17.6	0.29	28.2	0.47	40.5	0.68	61.6	1.03

SPECIFYING MODEL NUMBER



SAMPLE MODEL NUMBER

A Techline EZ Dripline = TLEZ

1 EMITTER FLOW RATE
 0.26 GPH = 26
 0.42 GPH = 4
 0.61 GPH = 6
 0.92 GPH = 9

2 EMITTER SPACING
 6" = 6
 12" = 12
 18" = 18
 24" = 24

3 COIL LENGTH
 200' = 02
 250' = 025
 300' = 03
 500' = 05
 1,000' = 10

ORDERING INFORMATION

FLOW RATE	FLOW CODE	EMITTER SPACING	COIL LENGTH	*MODEL NUMBER
0.26	26	6"	100'	TLEZ X -601
			250'	TLEZ X -6025
			500'	TLEZ X -605
			1,000'	TLEZ X -610
0.42	4	12"	100'	TLEZ X -1201
			250'	TLEZ X -12025
			500'	TLEZ X -1205
			1,000'	TLEZ X -1210
0.61	6	18"	100'	TLEZ X -1801
			250'	TLEZ X -18025
			500'	TLEZ X -1805
			1,000'	TLEZ X -1810
0.92	9	24"	1,000'	TLEZ X -2410

BLANK TUBING

COIL LENGTH	MODEL NUMBER
200'	TLEZ-02
250'	TLEZ-025
300'	TLEZ-03
500'	TLEZ-05
1,000'	TLEZ-10

* Substitute **X** in the Model Number with Flow Code

* See General Guideline on Page 7.

12mm & 17mm FITTINGS

For Techline® Copper, HCVXR-RW/RWP, CV XR, CV, DL, RW and RWP.

APPLICATIONS

- Fits Techline Copper, HCVXR-RW/RWP, CV XR, CV, DL, RW and RWP Driplines, and PE irrigation hose

SPECIFICATIONS

- 17mm acceptable hose sizes: 0.56" - 0.60" inside diameter
- 12mm acceptable hose size: 0.426" inside diameter

FEATURES & BENEFITS

BARBED FITTINGS

For secure fit and easy installation without clamps, glue or tools.

UV RESISTANT

Withstands heat, direct sun and harsh chemicals.

ONE-PIECE CONSTRUCTION

For added strength, durability and long-term performance.

ALLOWS FOR EASY ON-SITE INSPECTION

For proper fitting and installation.



INSERT COUPLING
17mm Model TLCOUP
12mm Model TL12COUP



1/2" MPT ADAPTER
17mm Model TL050MA
12mm Model TL12050MA



INSERT ADAPTER FOR 1" OR LARGER PE
(requires 11mm or 7/16" punch)
17mm Model TLIAPVC-B



INSERT ADAPTER FOR 1 1/2" OR LARGER PVC
(requires TDBIT16.5)
17mm Model TLIAPVC-B
12mm Model T12IAPVC-B



INSERT ELBOW
17mm Model TLELL
12mm Model T12LELL



3/4" MPT ADAPTER
17mm Model TL075MA
12mm Model T12075MA



INSERT CROSS
(requires 11mm or 7/16" punch)
17mm Model TLCROS
12mm Model T12CROS



EMITTER MICRO-TUBING ADAPTER
17mm Model TLMTUBEADP



INSERT TEE
17mm Model TLTEE
12mm Model T12TEE



COMBINATION TEE
INS x INS x 1/2" FPT
17mm Model TL050FTEE
INS x INS x 3/4" FPT
17mm Model TL075FTEE
12mm Model T12075FTEE



3/4" MPT x 'V'
17mm Model TL2W075MA
12mm Model T122W075MA



REDUCING COUPLING
12MM BARB x 17MM BARB
Model T12RCOUP



MANUAL FLUSH VALVE
12mm Model T12SOV



FIGURE 8 LINE END
Model TFIG8



MANUAL FLUSH VALVE
Model TISOV

MPT = Male Pipe Thread

INS x INS = Insert x Insert

FPT = Female Pipe Thread

TECHLOCK FITTINGS

For 16mm and 17mm Techline® and Polyethylene (PE) Tubing.

APPLICATIONS

- Fits HCVXR, HCVXR-RW and RWP, CVXR, CV, DL, RW and RWP driplines, and PE tubing

SPECIFICATIONS

- Tubing internal diameter: 0.530" - 0.560"
- Tubing wall thickness: 0.035" - 0.050"
- Tubing outside diameter: 0.600" - 0.660"
- Working temperature range: 32° F - 140° F
- Operating pressure: 0 to 100 psi
- Pull-out resistance: 67 ft-lbs.
- Warranty: 10 years for below ground (subsurface) installations 5 years for above ground (surface) installations

FEATURES & BENEFITS

SIMPLE AND EFFICIENT INSTALLATION WITH REDUCED PHYSICAL STRAIN

Ergonomic design enables quick field installation and reuse while reducing physical strain on installation crews.

INDUSTRY LEADING PRESSURE RATING

Get maximum performance and durability with our industry leading pressure rating and pullout resistance.

WARRANTY ENSURES CONFIDENCE

Specifiers, contractors and distributors will have peace of mind with our warranty - 10 years for subsurface installations and 5 years for surface installations.

SIZE RANGE FLEXIBILITY

16mm and 17mm outside diameter size range simplifies the job for designers and contractors.

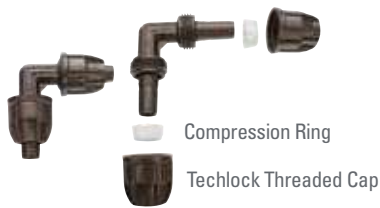

TECHLOCK ELBOW FITTING

Barb ends fit securely on the tubing while the techlock threaded caps and compression rings ensure a tight seal.



TECHLOCK COUPLER
Model TLCKCOUP



TECHLOCK ELBOW
Model TLCKELL



TECHLOCK 3/4" MPT ADAPTER
Model TLCK075MA



TECHLOCK TEE
Model TLCKTEE

INSTALLATION TOOLS



DRILL BIT FOR PVC INSERT ADAPTER
Model TDBIT16.5



PRESSURE GAUGE (0-30 psi)
Model GAUGE30



PRESSURE GAUGE (0-100 psi)
Model GAUGE100



SHRADER VALVE (1/8" MPT)
Model 61APS1/8



PRESSURE GAUGE NEEDLE
Model 6809091



WHEELBARROW TUBING DISPENSER
Model WBTD

DRIPLINE COMPONENTS

AIR/VACUUM RELIEF AIR VENTS

APPLICATIONS

- 1/2" Air Vents**
- Install in subsurface systems
- 3/4", 1" and 2" Guardian Air Vents**
- Install in subsurface systems
 - On sloping terrain to prevent collapsing of pipes caused by vacuum when pipe networks drain
 - For air discharge during system start-up

SPECIFICATIONS

- 1/2" Air Vents**
- Maximum operating pressure: 140 psi
- 3/4", 1" And 2" Guardian Air Vents**
- Maximum operating pressure: 150 psi
 - Made of corrosion-resistant reinforced UV protected composite materials - no metal parts to rust or corrode, no need for spare parts

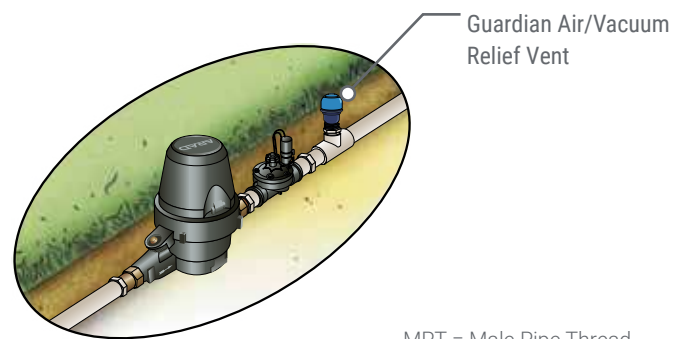
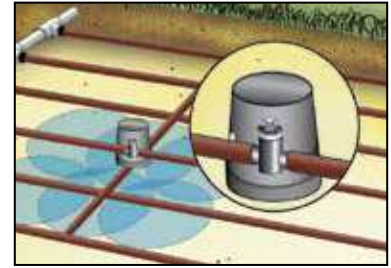

MPT = Male Pipe Thread
FPT = Female Pipe Thread

DRIPLINE COMPONENTS

COMBINATION AIR VENTS

APPLICATIONS

- For discharge of large volumes of air, along mains and at the end of mainlines
- Place before water meters and automatic metering valves for accurate flow readings
- Place at high points in pipe network or upstream of manifolds

SPECIFICATIONS

- Mini**
- Continuous acting
 - Maximum operating pressure: 150 psi
 - Sizes: 1/2" and 3/4" MPT (2.4" w x 4.5" h)
- Combination**
- Continuous acting
 - Maximum operating pressure: 150 psi
 - Size: 1" MPT (3.9" w x 5.5" h)

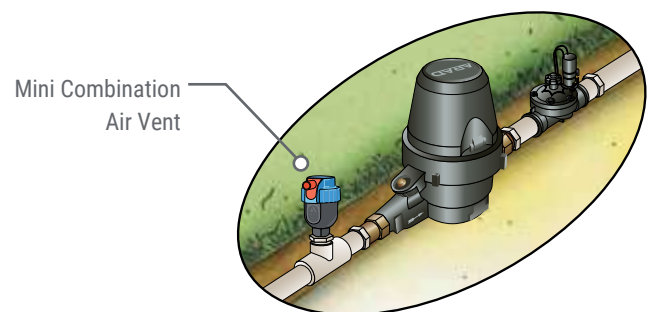

MPT = Male Pipe Thread

DRIPLINE COMPONENTS

AUTOMATIC FLUSH VALVES

APPLICATIONS

- Drip irrigation systems
- Clean or dirty water

SPECIFICATIONS

- Not required with Techline Copper and CV
- Flushing water volume: approximately 1 gallon per cycle
- Maximum zone flow rate per valve flush: 15 GPM
- Minimum pressure required: 1.5 psi
- Maximum operating pressure: 57 psi

FEATURES & BENEFITS

FLUSHING REDUCES SEDIMENT BUILD-UP

Eliminates clogging. Promotes long-term performance of the drip irrigation system.

AUTOMATIC CLEANING OPERATION

Eliminates periodic manual flushing.

UNIQUE DESIGN REACTS TO FLOW, NOT PRESSURE

Allows operation even at full line pressure.

DISASSEMBLES FOR WINTERIZATION 'BLOWOUT'

Protects your drip system.



AUTOMATIC FLUSH VALVE 1/2" MPT INLET
Model TL050MFV-1



AUTOMATIC FLUSH VALVE INSERT INLET
Model TLFV-1



Diaphragm in open position allows flushing.

As irrigation starts, valve flushes out dirt particles in the open position.

After flushing, the valve closes and normal system operation begins.

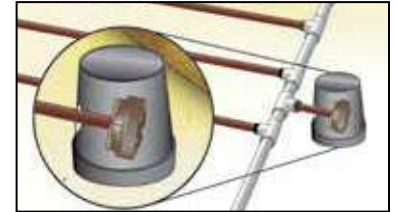

MPT = Male Pipe Thread

DRIPLINE COMPONENTS

INLINE CHECK VALVE

APPLICATIONS

- Prevents backflow of water and drainage of the system into low areas
- Eliminates the need for system water refill at the beginning of the next irrigation cycle
- For irrigating slopes where draining of the headers and laterals is common (13.4 feet of holdback)

SPECIFICATIONS

- Flow rate: 0.9 - 4.4 GPM
- Closing pressure: 5.8 psi (13.4 feet column of water)
- Opening pressure: 10.2 psi

FEATURES & BENEFITS

MANUFACTURED FROM DURABLE MATERIALS

For reliable operation.

LARGE INLET OPENING

Reduces headloss.

WIDE FLOW RANGE

For use in a number of applications.



IN-LINE CHECK VALVE
1/2" MPT
Model TLCV050M1-B

FLOW RATE VS. PRESSURE LOSS

FLOW RATE (GPM) VS. PRESSURE LOSS (psi)									
0.5	1	1.5	2	2.5	3	3.5	4	4.5	
-	0.22	0.54	0.96	1.55	2.25	2.99	4.04	-	

MPT = Male Pipe Thread

DRIPLINE COMPONENTS

TECHLINE® HCVXR & CV MISTER OPERATION INDICATOR

FEATURES & BENEFITS

FOGGING NOZZLE EMITS A FINE MIST

Indicates system operation and minimum required system pressure.

CREATES A MOISTENED AREA SURROUNDING THE FOGGER

Showing zone operation.

OPERATION

Techline CV emitters open at 14.5 psi line pressure.

Techline Copper emitters open at 21.8 psi line pressure.

Indicator stake's check valve opens and activates the fogging nozzle at 22 psi line pressure.

SPECIFICATIONS

- Fogging rate: less than 2.0 GPH, creating a moistened area approximately 2' outward from nozzle
- Check valve: opens at 22 psi, closes at 10 psi
- Fogging nozzle maximum flow rate: 2.0 GPH at 60 psi
- Pre-assembled with fogging nozzle, check valve, anchoring stake, tubing and barb connector



TECHLINE COPPER AND CV MISTER
Model 10-CV-01

DRIPLINE COMPONENTS

TECHLINE® DL & EZ OPERATION FLAG

FEATURES & BENEFITS

FLAG RAISES TO INDICATE SYSTEM OPERATION

With just a minimum of 10 psi operating pressure.

SPECIFICATIONS

- Down flag position (closed): 4.5 psi or lower
- Halfway flag position (45°): 7 psi
- Upright flag position (90° or open): 10 psi or higher
- Pre-assembled with indicator flag, anchoring stake, tubing and barb connector



OPERATION FLAG
Model 10-F-01

LOW VOLUME CONTROL ZONE KITS

Low Flow and High Flow Zones with Disc or Screen Filter

APPLICATIONS

- Designed for all dripline, drip and micro-spray zones
- Residential or commercial landscape irrigation applications
- For zones between 0.25 and 35 GPM

SPECIFICATIONS

- Disc Filter mesh: **140**
- Screen Filter mesh: **155**
- Maximum pressure for all kits: **140 psi**

¾" and 1" Low Flow Kits:

PRV flow range: 0.25 - 4.4 GPM
Regulated pressure: 42 psi

¾" and 1" High Flow Kits:

PRV flow range: 4.5 - 17.6 GPM
Regulated pressure: 57 psi

1 ½" High Flow Kits:

PRV flow range: 11 - 35 GPM
Regulated pressure: 57 psi

FEATURES & BENEFITS

LOWEST PRESSURE LOSS IN THE INDUSTRY

Get more zone control for your money with smaller units and less units required for higher flows.

100% COMPATIBLE WITH ALL 2-WIRE CONTROLLERS

Save installation costs and get peace of mind with this completely 2-Wire compatible model. Inrush and holding currents are 50-60% lower than the industry average allowing the industry's longest wire runs from valve to controller.

IDEAL DRIP ZONE PRESSURE REGULATION

Achieve maximum hydraulic performance with higher pressure outputs designed to deliver the longest run lengths.

DISC FILTER MODELS AVAILABLE













Get the best possible protection for your drip system with the proven performance of disc filtration.

*See individual product page for more specification information.



HIGH FLOW KIT WITH 1" CONTROL VALVE
Model LVCZ10075-HFHP



APPLICATION	DISC FILTERS		SCREEN FILTERS	
	WITH VALVES	WITHOUT VALVES	WITH VALVES	WITHOUT VALVES
COMMERCIAL High Flow: 11 to 35 GPM	 KIT WITH 1 1/2" CONTROL VALVE (1 1/2" FPT Inlet x 1 1/2" MPT Outlet) LVCZ-150HP	 KIT WITH NO CONTROL VALVE (1 1/2" MPT Inlet x 1 1/2" MPT Outlet) LVCZ-150HP-NV	 KIT WITH 1 1/2" CONTROL VALVE (1 1/2" FPT Inlet x 1 1/2" MPT Outlet) LVCZSF-150HP	 KIT WITH NO CONTROL VALVE (1 1/2" MPT Inlet x 1 1/2" MPT Outlet) LVCZSF-150HP-NV
RESIDENTIAL & COMMERCIAL High Flow: 4.5 to 17.6 GPM	 HIGH FLOW KIT WITH 1" CONTROL VALVE (1" FPT Inlet x 3/4" MPT Outlet) LVCZ10075-HFHP	 HIGH FLOW KIT WITH NO CONTROL VALVE (3/4" MPT Inlet x 3/4" MPT Outlet) LVCZNV10075-HFHP	 HIGH FLOW KIT WITH 1" CONTROL VALVE (1" FPT Inlet x 3/4" MPT Outlet) LVCZSF10075-HFHP	 HIGH FLOW KIT WITH NO CONTROL VALVE (3/4" MPT Inlet x 3/4" MPT Outlet) LVCZNVSF10075-HFHP
RESIDENTIAL & COMMERCIAL Low Flow: 0.25 to 4.4 GPM	 LOW FLOW KIT WITH 1" CONTROL VALVE (1" FPT Inlet x 3/4" FPT Outlet) LVCZS8010075-LF	 LOW FLOW KIT WITH NO CONTROL VALVE (3/4" MPT Inlet x 3/4" FPT Outlet) LVCZNV10075-LF	 LOW FLOW KIT WITH 1" CONTROL VALVE (1" FPT Inlet x 3/4" FPT Outlet) LVCZS80SF10075-LF	 LOW FLOW KIT WITH NO CONTROL VALVE (3/4" MPT Inlet x 3/4" FPT Outlet) LVCZNVSF10075-LF

LOW VOLUME CONTROL ZONE KITS

FLOW RATE VS. PRESSURE LOSS

APPLICATION	FLOW RATE (GPM)	DISC FILTERS		SCREEN FILTERS	
		WITH VALVE	WITHOUT VALVE	WITH VALVE	WITHOUT VALVE
		MINIMUM INLET PRESSURE (psi) TO ACHIEVE REGULATED OUTLET PRESSURE			
COMMERCIAL High Flow: 11 to 35 GPM (57 psi Output)	10	64.4	61.4	64.4	61.4
	13	65.1	62.0	64.8	61.7
	17	65.6	62.3	65.4	62.1
	22	66.6	63.1	65.9	62.4
	26	67.3	63.7	66.6	63.0
	31	68.5	64.7	67.5	63.9
RESIDENTIAL AND COMMERCIAL High Flow: 4.5 to 17.6 GPM (57 psi Output)	5	64.2	61.4	63.7	60.9
	10	68.0	64.5	65.7	62.2
	13	70.8	67.2	67.7	64.1
	17	75.2	71.3	69.7	65.8
RESIDENTIAL AND COMMERCIAL Low Flow: 0.25 to 4.4 GPM (42 psi Output)	1	47.0	45.1	46.9	45.0
	2	47.3	45.3	47.1	45.1
	3	47.8	45.5	47.5	45.2
	4	48.2	45.7	47.9	45.4
	5	48.8	46.0	48.3	45.5

*Example: See highlighted cell above - for a residential and commercial high flow kit with valve and screen filter at 10 GPM, input required = 65.7 psi for constant output of 57 psi (implied head loss = 8.7 psi)

ORDERING INFORMATION

DESCRIPTION	QTY	DISC FILTER MODEL NUMBER	SCREEN FILTER MODEL NUMBER
1" VALVE WITH 3/4" LOW FLOW REGULATOR WITH 3/4" FILTER	1	LVCZS8010075-LF	LVCZS80SF10075-LF
	6	LVCZS8010075-LF-B	LVCZS80SF10075-LF-B
1" VALVE WITH 3/4" HIGH FLOW REGULATOR WITH 3/4" FILTER	1	LVCZ10075-HFHP	LVCZSF10075-HFHP
	6	LVCZ10075-HFHP-B	LVCZSF10075-HFHP-B
1 1/2" VALVE WITH 1 1/2" HIGH FLOW REGULATOR WITH 1 1/2" FILTER	1	LVCZ-150HP	LVCZSF-150HP
3/4" LOW FLOW REGULATOR WITH 3/4" FILTER, NO VALVE	1	LVCZNV10075-LF	LVCZNVSF10075-LF
	10	LVCZNV10075-LF-B	LVCZNVSF10075-LF-B
3/4" HIGH FLOW REGULATOR WITH 3/4" FILTER, NO VALVE	1	LVCZNV10075-HFHP	LVCZNVSF10075-HFHP
	10	LVCZNV10075-HFHP-B	LVCZNVSF1075HFHP-B
1 1/2" HIGH FLOW REGULATOR WITH 1 1/2" FILTER, NO VALVE	1	LVCZ-150HP-NV	LVCZSF-150HP-NV

1" CONTROL ZONES

1" Valve, 1" Wide Range Pressure Regulator and 1" Screen Filter

SPECIFICATIONS

- Flow Range: 0.5 - 30 GPM
- Regulated pressure: 50 psi
- Maximum pressure: 140 psi
- Screen Filter mesh: 155

SERIES 80 VALVE MATERIALS:

- Glass reinforced polyamide body, bonnet and seat; Buna-N rubber diaphragm; Stainless steel 304 nuts, bolts and washer; Stainless Steel ANSI 302 spring

SCREEN FILTER MATERIALS:

- Polypropylene body; nylon screen; EPDM rubber o-rings

WIDE RANGE PRESSURE REGULATOR (WRPR) MATERIALS:

- ABS Plastic body/valve; PVC threads; stainless steel spring; EPDM diaphragm

*See individual product page for more specification information.

FEATURES & BENEFITS

LOWEST PRESSURE LOSS IN THE INDUSTRY

Get more zone control for your money with smaller units and less units required for higher flows.

100% COMPATIBLE WITH ALL 2-WIRE CONTROLLERS

Save installation costs and get peace of mind with this completely 2-Wire compatible model. Inrush and holding currents are 50-60% lower than the industry average allowing the industry's longest wire runs from valve to controller.

EFFICIENT FILTRATION

Nylon screen collects debris for efficient filtration and non-corrosive materials are resistant to chemicals and fertilizers.

IDEAL DRIP ZONE PRESSURE REGULATION

Achieve maximum hydraulic performance with higher pressure outputs designed to deliver the longest run lengths.

1" CONTROL ZONE with Valve



1" SERIES 80 GLOBE ELECTRIC CONTROL VALVE



FLOW RATE VS. PRESSURE

APPLICATION	FLOW RATE (GPM)	1" CONTROL ZONE		
		WITH VALVE	WITHOUT VALVE	REGULATED OUTLET PRESSURE (psi)
		MINIMUM INLET PRESSURE (psi) TO ACHIEVE REGULATED OUTLET PRESSURE		
RESIDENTIAL AND COMMERCIAL	0.5	56	55	55
	1	56	55	53
	5	56	54	52
	10	58	55	50
	15	60	57	50
	20	65	61	48
	25	65	61	46
	30	70	64	46

ORDERING INFORMATION

DESCRIPTION	MODEL NUMBER
1" VALVE WITH 1" WIDE RANGE PRESSURE REGULATOR AND 1" SCREEN FILTER	NCZ-1S
1" WIDE RANGE PRESSURE REGULATOR, 1" SCREEN FILTER, NO VALVE	NCZ-NV1S

CONNECTIONS

COMPONENT	CONNECTION
VALVE	1" FPT INLET/OUTLET
SCREEN FILTER	1" MPT INLET/OUTLET
WRPR PRESSURE REGULATOR	1" FPT INLET/OUTLET

FPT = Female Pipe Thread MPT = Male Pipe Thread

PRESSURE REGULATORS

For Constant Outlet Pressure

APPLICATIONS

- All irrigation systems

SPECIFICATIONS

- 3/4" Low Flow model: 0.25 to 4.4 GPM
- 3/4" High Flow model: 4.5 to 17.6 GPM
- 1 1/2" model: 11 to 35 GPM
- Other models available up to 175 GPM
- Maximum operating pressure: 145 psi
- 1" Wide Range Pressure Regulator
- 1" FPT x 1" FPT connections
- Operating inlet pressure range: 10 to 150 psi
- Wide flow range: 0.5 to 35 GPM
- Available pressures: 30, 40 and 50 psi
- Materials: ABS plastic body/valve, PVC threads, stainless steel spring and EPDM diaphragm

FEATURES & BENEFITS

EASY INLINE ASSEMBLY

3/4" low flow model - female inlet/outlet. 3/4" high flow model - female inlet and male outlet.

SEALED REGULATING MODULE

Available on 3/4" high flow and 1 1/2" pressure regulators.

BUILT-IN INDICATOR ON 3/4" HIGH FLOW AND LARGER MODELS

Indicates when proper outlet pressure is achieved.

WIDE FLOW RANGE = SIMPLICITY

The only 1" regulator in the industry rated from 0.5 to 35 GPM, providing simplicity for contractors, architects and distributors.

RELIABLE PERFORMANCE

Rolling diaphragm and sealed regulating chamber provide consistent, high quality performance in any irrigation system.

DURABILITY

Chemical resistant, high strength ABS construction and stainless steel springs provide long-life and can be used in a variety of applications where chemicals or aggressive water may be present.



PRESSURE REGULATORS

For Constant Outlet Pressure

ORDERING INFORMATION

DESCRIPTION	PSI	GPM	MODEL NUMBER
LOW FLOW INLINE 3/4" FPT INLET x FPT OUTLET	15	0.25 to 4.4	PRV075LF15V2K
	20		PRV075LF20V2K
	25		PRV075LF25V2K
	35		PRV075LF35V2K
	42		PRV075LF42V2K
	50	PRV075LF50V2K	
HIGH FLOW 3/4" FPT INLET x MPT OUTLET	15	4.5 to 17.6	PRV075HF15V2K
	20		PRV075HF20V2K
	25		PRV075HF25V2K
	35		PRV075HF35V2K
	45		PRV075HF45V2K
	50		PRV075HF50V2K
	57	PRV075HF57V2K	
1 1/2" MPT x MPT	15	11 to 35	PRV15015V2K
	20		PRV15020V2K
	25		PRV15025V2K
	35		PRV15035V2K
	45		PRV15045V2K
	50		PRV15050V2K
	57		PRV15057V2K
REPLACEMENT PRESSURE REGULATING MODULE	15		PRVU15V2K
	20		PRVU20V2K
	25		PRVU25V2K
	35		PRVU35V2K
	45		PRVU45V2K
	50		PRVU50V2K
	57		PRVU57V2K
1" FPT INLET x 1" FPT OUTLET	30		WRPR1-30
	30		WRPR1-30C
	40		WRPR1-40
	40		WRPR1-40C
	50		WRPR1-50
	50		WRPR1-50C

FPT = Female Pipe Thread MPT = Male Pipe Thread

3/4" LOW FLOW - OUTLET VS. INLET PRESSURE (@13 GPM)

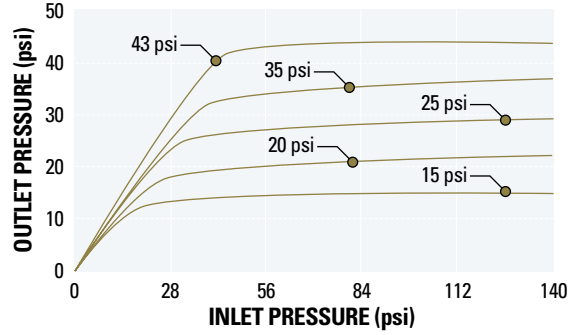

FLOW RATE VS. PRESSURE

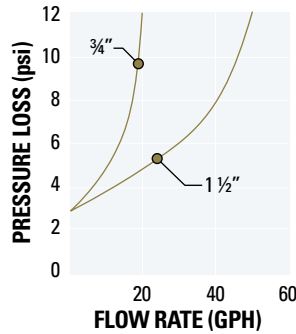

PERFORMANCE DATA

MODEL NUMBER	WRPR1-30	WRPR1-40	WRPR1-50
FLOW RANGE	0.5 - 35 GPM	0.5 - 35 GPM	0.5 - 35 GPM
OUTLET PRESSURE SETTING	30 psi	40 psi	50 psi
MAXIMUM INLET PRESSURE	150 psi	150 psi	150 psi

SERIES 80 NYLON VALVES

Reliable, Durable Control and Master Valves

APPLICATIONS

- Residential or commercial landscape irrigation applications
- For mild corrosive and mild acidity levels in the water
- For remote control, master valve and automated operations
- Reclaimed/reuse applications including municipally treated reclaimed water designated for irrigation

SPECIFICATIONS

- Recommended flow range:
 - ¾" - 0.01 to 26 GPM
 - 1" - 0.01 to 44 GPM
 - 1 ½" - 0.25 to 110 GPM
 - 2" - 0.25 to 176 GPM
- Minimum operating pressure: 7 psi
- Maximum operating pressure: 150 psi
- Water temperature: up to 140° F
- 24VAC solenoid standard ± 10% voltage
- Solenoid inrush current: 0.220A
- Solenoid holding current: 0.095A
- Optional solenoids: 24VDC, 12VDC, 12VDC-latching and 120VAC
- Integral stainless steel Easyclean® filter for 1 ½" and 2" models only
- Adjustable pressure regulator option available: 1.5" and 2" Model
 - Normally Closed Option: ¾" - 2"
 - Normally Open Option: 1 ½" - 2"

MATERIALS

- Body, bonnet, seat and diaphragm: glass reinforced polyamide (GRP)
- Diaphragm: Buna-N rubber
- Nuts, bolts and washers: stainless steel 304
- Spring: stainless steel AISI 302

FEATURES & BENEFITS

EASIEST OPERATION AND LOWEST MAINTENANCE COSTS

New and improved manual selector allows for hassle-free internal bleed without manipulating the position of the solenoid. Innovative labyrinth inlet eliminates the need for internal filters, reducing service costs for end users, contractors and Distributors.

FLOW CONTROL STANDARD ON ALL MODELS

Manual zone control from fully closed to maximum capacity at no extra charge.

HIGH EFFICIENCY, LONGER LASTING SOLENOID

Inrush and holding current are 50-60% lower than the industry average which allows the industry's longest wire runs from valve to controller. Low sensitivity to dirt and voltage fluctuations.

PROVEN RELIABILITY WITH RECLAIMED WATER

Over a decade of field-proven, consistent performance under the harshest water conditions. Durable and corrosion-resistant materials.

2-WIRE SYSTEM COMPATIBILITY

Works with all major manufacturer 2-Wire control systems.

QUICK PRESSURE RELIEF VALVE (QR VALVE)

Pilot-operated valve eliminates sticking, adds the reliability of opening and closing, and offers more flexibility and adjustments. Leak-proof design ensures zero-leakage in high pressure applications.



3/4" AND 1" GLOBE
ELECTRIC CONTROL VALVE



Encapsulated
Solenoid



1 1/2" GLOBE
MANUAL ELECTRIC
MASTER
OR CONTROL VALVE



2" GLOBE
PRESSURE REDUCING ELECTRIC
MASTER OR CONTROL VALVE



QUICK PRESSURE
RELIEF VALVE
(QR VALVE)

SERIES 80 NYLON VALVES

Reliable, Durable Control and Master Valves

3/4" and 1" MODELS FLOW RATE VS. PRESSURE LOSS

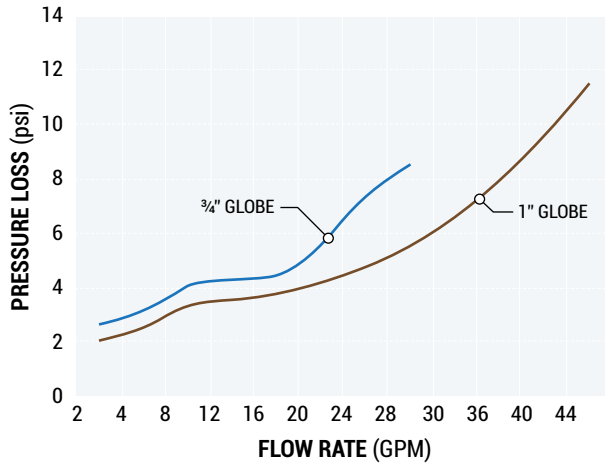

1 1/2" and 2" MODELS FLOW RATE VS. PRESSURE LOSS

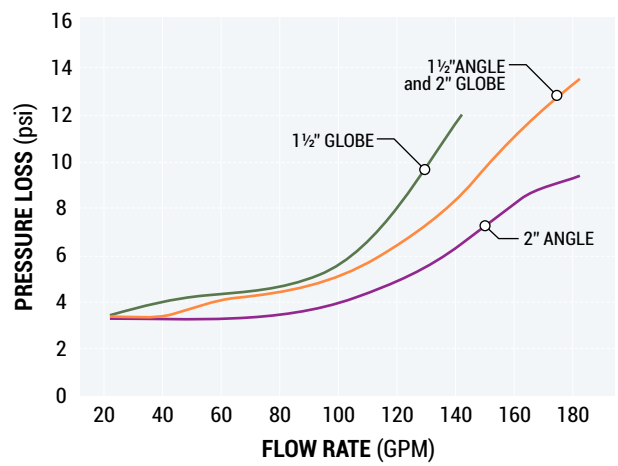

1 1/2" and 2" MODELS FLOW RATE VS. PRESSURE LOSS

FLOW (GPM)	PRESSURE LOSS (psi)			
	1 1/2" GLOBE	1 1/2" ANGLE	2" GLOBE	2" ANGLE
20	3.3	3.3	3.3	3.3
40	4.0	3.3	3.3	3.3
60	4.3	4.0	4.0	3.3
80	4.5	4.3	4.3	3.6
100	5.5	5.0	5.0	4.1
120	8.5	6.5	6.5	5.0
140	12.0	8.5	8.5	6.5
160	-	-	11.5	8.5
180	-	-	13.5	9.5

ORDERING INFORMATION

DESCRIPTION	SIZE	MODEL NUMBER
SERIES 80* VALVES WITH STANDARD 24VAC	3/4" GLOBE	LVET.75GH2
	1" GLOBE	LVET1GH2
	1 1/2" GLOBE	LVET1.5GH2
	2" GLOBE	LVET2GH2
	1 1/2" ANGLE	LVET1.5GH2-AN
MANUAL ELECTRIC NORMALLY CLOSED	2" ANGLE	LVET2GH2-AN
	1 1/2" GLOBE	LV61METNC1.5GH3
	1 1/2" ANGLE	LV61METNC1.5GH3A
	2" GLOBE	LV61METNC2GH3
MANUAL ELECTRIC NORMALLY OPEN	2" ANGLE	LV61METNC2GH3A
	1 1/2" GLOBE	LV61METNO1.5GH3
	1 1/2" ANGLE	LV61METNO1.5GH3A
	2" GLOBE	LV61METNO2GH3
PRESSURE REDUCING ELECTRIC NORMALLY CLOSED	2" ANGLE	LV61METNO2GH3A
	1 1/2" GLOBE	LV61PRMETNC1.5GH3
	1 1/2" ANGLE	LV61PRMETNC1.5GH3A
	2" GLOBE	LV61PRMETNC2GH3
PRESSURE REDUCING ELECTRIC NORMALLY OPEN	2" ANGLE	LV61PRMETNC2GH3A
	1 1/2" GLOBE	LV61PRMETNO1.5GH3
	1 1/2" ANGLE	LV61PRMETNO1.5GH3A
	2" GLOBE	LV61PRMETNO2GH3
SERIES 80 QR VALVES	2" ANGLE	LV61PRMETNO2GH3A
	2" ANGLE	LV61QR2PLS80-AN-Y
	3" ANGLE	LV61QR3PLS80-AN-Y

*Series 80 Standard Globe Valve used in LVCZ Kits.

3/4" and 1" MODELS FLOW RATE VS. PRESSURE LOSS

FLOW (GPM)	PRESSURE LOSS (psi)	
	3/4" GLOBE	1" GLOBE
2	2.5	2
4	3	2.5
8	4	3.4
12	4.1	3.5
16	4.4	3.9
20	5.5	4.1
24	7.5	4.7
28	8.5	5.4
32	-	6.5
36	-	8
40	-	9.5
44	-	11.5

CONTROLLER TO VALVE MAXIMUM WIRE LENGTHS

GAUGE	LENGTH
12	6,800'
14	4,300'
16	2,700'
18	1,700'
20	1,000'

QUICK SELECTION GUIDE

VALVE SIZE	MINIMUM PILOT PRESSURE (PSI)	PRESET PILOT PRESSURE (PSI)	MAXIMUM PILOT PRESSURE (PSI)	MINIMUM FLOW RATE (PSI)	PRESET FLOW RATE (PSI)	MAXIMUM FLOW RATE (PSI)
2" ANGLE	15	70	115	50	307	394
3" ANGLE				150	691	885

APPLICATIONS

- Residential, institutional, commercial, municipal and golf
- Functions:
 - Electric (Master Valve)
 - Pressure Reducing
 - Pressure Sustaining
 - Quick Relief
 - Pump Control

SPECIFICATIONS

- For Electric Valves:
 - Volts: 24VAC standard \pm 10% voltage
 - Optional: 24VDC, 12VDC, 12VDC-latching and 120VAC
- For Iron Valves:
 - Diaphragm pressure range: 17 - 230 psi
- For Nylon and PVC Valves:
 - Diaphragm pressure range: 7 - 150 psi

MATERIALS

- Nuts, Bolts and Washers: stainless steel
- Body: cast iron, nylon or PVC
- Spring: stainless steel
- Diaphragm assembly: natural rubber (EPDM and nitril available on request)

FEATURES & BENEFITS

CAST IRON MODEL

Durable, high pressure valves up to 230 psi.

NYLON AND PVC MODELS

Durable, corrosion resistant materials provide high resistance to corrosive water containing fertilizers and chemicals.

RESISTS CAVITATION

Where extreme flow velocities and high pressure differentials exist.

LOWEST FRICTION LOSS IN THE INDUSTRY

Unique design allows a straight flow pattern. The valve allows free passage in the fully open valve with minimal headloss at very high flows.

CONSTRUCTED OF MINIMAL PARTS

Structural simplicity and low maintenance.

EQUIPPED WITH DIRECT SEALING DIAPHRAGM

There are no shafts, bearings or seals to corrode and there is no wear and tear by dirty abrasive water or chemicals. The diaphragm is the only moving part.

SUPERB PRESSURE REGULATION

Valves can be used for regulating no flow to maximum flow with no need for additional throttling devices or bypass valves.



CAST IRON FLANGED VALVE
(Pressure Reducing Electric)



PVC SLIP VALVE
(Pressure Reducing)



NYLON THREADED VALVE
(Pressure Reducing Electric)

IRON, NYLON AND PVC VALVES

Durable High Pressure Valves

HYDRAULIC SPECIFICATIONS	2"	3"	4"
MAXIMUM RECOMMENDED FLOW RATE CONTINUOUS VALVE (18 FEET PER SECOND - GPM)	180	400	700
NOMINAL RECOMMENDED FLOW RATE CONTINUOUS VALVE (8 FEET PER SECOND - GPM)	80	176	330
MAXIMUM RECOMMENDED FLOW RATE INTERMITTENT VALVE (49 FEET PER SECOND - GPM)	485	1,080	1,915
MINIMUM FLOW (GPM)	<1	<1	<1
FLOW FACTOR (CV)	110	200	260
OPERATING PRESSURE RANGE HIGH PRESSURE DIAPHRAGM (psi)	21-230	21-230	17-230
OPERATING PRESSURE RANGE LOW PRESSURE DIAPHRAGM (psi)	10-145	10-145	6-145

FLOW RATE VS. PRESSURE LOSS

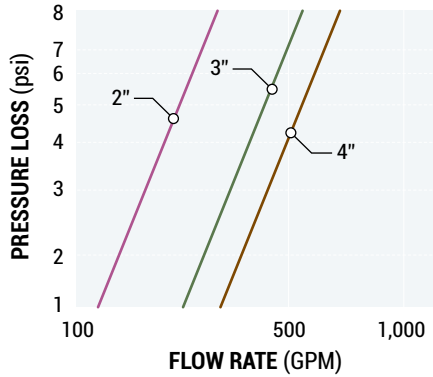

Cv TABLE

SIZES	2"	3"	4"
FLOW FACTOR (Cv) in GPM	110	200	260

AVAILABLE MODELS

CONNECTION	THREADED			FLANGED	SLIP
	IRON	NYLON	PVC	IRON	PVC
2"	✓	✓			
3"	✓		✓	✓	
4"				✓	✓

6" - 24" Cast Iron Valves are available in flange configuration.
6" PVC Valves are also available.

ORDERING INFORMATION

DESCRIPTION	SIZE	MODEL NUMBER
IRON MANUAL ELECTRIC VALVES	2" THREADED N.C.	LV61MELNC2IT-HP
	2" THREADED N.O.	LV61MELNO2IT-HP
	3" THREADED N.C.	LV61MELNC3IT-HP
	3" THREADED N.O.	LV61MELNO3IT-HP
	3" FLANGED N.C.	LV61MELNC3IF-HP
	3" FLANGED N.O.	LV61MELNO3IF-HP
	4" FLANGED N.C.	LV61MELNC4IF-HP
	4" FLANGED N.O.	LV61MELNO4IF-HP
IRON PRESSURE REDUCING MANUAL ELECTRIC VALVES	2" THREADED N.C.	LV61PRMELNC2IT-HP
	2" THREADED N.O.	LV61PRMELNO2IT-HP
	3" THREADED N.C.	LV61PRMELNC3IT-HP
	3" THREADED N.O.	LV61PRMELNO3IT-HP
	3" FLANGED N.C.	LV61PRMELNC3IF-HP
	3" FLANGED N.O.	LV61PRMELNO3IF-HP
	4" FLANGED N.C.	LV61PRMELNC4IF-HP
	4" FLANGED N.O.	LV61PRMELNO4IF-HP
NYLON AND PVC MANUAL ELECTRIC VALVES	2" NYLON THREADED N.C.	LV61MELNC2PL
	2" NYLON THREADED N.O.	LV61MELNO2PL
	3" PVC THREADED N.C.	LV61MELNC3PLT
	3" PVC THREADED N.O.	LV61MELNO3PLT
	4" PVC SLIP N.C.	LV61MELNC4PLS
	4" PVC SLIP N.O.	LV61MELNO4PLS
NYLON AND PVC PRESSURE REDUCING MANUAL ELECTRIC VALVES	2" NYLON THREADED N.C.	LV61PRMELNC2PL
	2" NYLON THREADED N.O.	LV61PRMELNO2PL
	3" PVC THREADED N.C.	LV61PRMELNC3PLT
	3" PVC THREADED N.O.	LV61PRMELNO3PLT
	4" PVC SLIP N.C.	LV61PRMELNC4PLS
	4" PVC SLIP N.O.	LV61PRMELNO4PLS

N.C. = Normally Closed Valve
N.O. = Normally Open Valve

APPLICATIONS

- Residential
- Commercial
- Municipal
- Institutional

SPECIFICATIONS

- Maximum pressure:
 $\frac{3}{4}$ " , 1" , 1 $\frac{1}{2}$ " : 140 psi
 2" Dual HP: 174 psi
- Flow range:
 $\frac{3}{4}$ " - 1 to 17 GPM
 1" - 5 to 26 GPM
 1 $\frac{1}{2}$ " - 10 to 35 GPM
 1 $\frac{1}{2}$ " Long - 10 to 52 GPM
 2" Dual HP - 40 to 120 GPM

MATERIALS

- Filter body and cover: reinforced polyamide
- Disc rings: polypropylene
- O-Rings: EPDM rubber
- Clamps: stainless steel

FEATURES & BENEFITS

DISC FILTER DESIGN

Collects debris along the depth of the discs, not just at the surface like screen filters. Disc helps filtration with calcium build up.

100% THERMOPLASTIC DISCS

Corrosion resistant. Disc screens prevents element collapsing.

REPLACEMENT FILTER RINGS AVAILABLE

Color-coded for easy mesh identification.

EXTRA LARGE FILTRATION CAPACITY

Requires less cleaning.

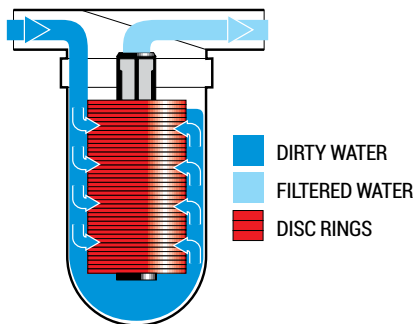

DISC FILTER TECHNOLOGY

Grooves in the disc rings criss-cross to form a network that traps debris between and on the outside of the discs.

HOW IT WORKS

As dirty water is pumped into the filter, and pressure increases, the water compresses the disc rings together tightly. The water is then forced to flow through the grooves of the disc rings, where debris is trapped, releasing only clean water to the irrigation system.

MANUAL DISC FILTERS

FLOW RATE VS. PRESSURE LOSS

FLOW RATE (GPM)	PRESSURE LOSS (psi)				FLOW RATE (GPM)	PRESSURE LOSS (psi)		
	3/4"	1"	1 1/2"	1 1/2" LONG		1 1/2"	1 1/2" LONG	2" DUAL HP
5	0.60	0.25			31	1.70	2.10	
10	2.50	0.60			35	2.30	2.50	
13	3.40	1.34			44		4.20	0.30
17	5.87	2.10			66			0.63
22		3.24	1.10		88			1.03
26			1.30	1.50	110			1.47

LEGEND

- River, ditch, lake or reservoir water
- Well water containing sand only
- Municipal supply

Losses shown are for filters with 140 mesh.

FLOW RATE VS. PRESSURE LOSS

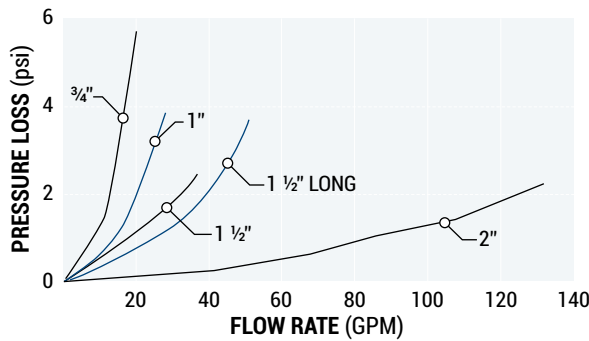

DISC FILTER RINGS



ORDERING INFORMATION

FILTER SIZE	MESH	DISC FILTER MODEL NUMBER	REPLACEMENT FILTER RINGS MODEL NUMBER	FILTER SIZE	MESH	DISC FILTER MODEL NUMBER	REPLACEMENT FILTER RINGS MODEL NUMBER
3/4"	40	DF075-040	DFR075040	1 1/2" LONG	40	DF150S-040	DFR150L040*
	80	DF075-080	DFR075080		80	DF150S-080	DFR150L080*
	120	DF075-120	DFR075120		120	DF150S-120	DFR150L120*
	140	DF075-140	DFR075140		140	DF150S-140	DFR150L140*
1"	40	DF100-040	DFR150040*	2" DUAL HP	40	DF200-040	DFR200040
	80	DF100-080	DFR150080*		80	DF200-080	DFR200080
	120	DF100-120	DFR150120*		120	DF200-120	DFR200120
	140	DF100-140	DFR150140*		140	DF200-140	DFR200140
1 1/2"	40	DF150-040	DFR150040*		200	DF200-200	DFR200200
	80	DF150-080	DFR150080*				
	120	DF150-120	DFR150120*				
	140	DF150-140	DFR150140*				

* Ring set and filter spine.
140 Mesh: Standard for LVCZ Kit.

APPLICATIONS

- Residential
- Commercial
- Municipal
- Institutional

SPECIFICATIONS

- Maximum pressure: 140 psi
- Flow range
 - ¾" - 1 to 13 GPM
 - 1" - 1 to 30 GPM
 - 1 ½" - 1 to 66 GPM
 - 2" - 1 to 89 GPM
- Filtration area:
 - ¾" and 1" - 14.90 sq. in.
 - 1 ½" - 85.60 sq. in.
 - 2" - 104 sq. in.
- Mesh: 155 Micron: 90

MATERIALS

- Filter body: polypropylene
- Screen: nylon
- O-Rings: EPDM rubber

FEATURES & BENEFITS

SCREEN FILTER DESIGN

Collects debris along the nylon screen for efficient filtration.

MADE OF NON-CORROSIVE MATERIALS

Polypropylene body provides resistance to chemicals and fertilizers.

EASY MAINTENANCE

Unit easily unscrews for access to screen.



PRESSURE LOSS

FILTER SIZE 3/4"		FILTER SIZE 1"		FILTER SIZE 1 1/2"		FILTER SIZE 2"	
GPM	PSI	GPM	PSI	GPM	PSI	GPM	PSI
4.4	0.07	4.4	0.03	22.0	0.44	31.0	0.44
8.8	0.16	8.8	0.09	26.4	0.58	44.0	0.94
13.2	0.25	13.2	0.15	31.0	0.87	61.6	1.45
-	-	17.6	0.26	35.2	1.16	70.4	1.89
-	-	22.0	0.44	44.0	1.74	79.2	2.32
-	-	30.0	1.00	53.0	2.00	88.0	2.90

ORDERING INFORMATION

FILTER SIZE	MODEL NUMBER
3/4"	SF075-155
1"	SF100-155
1 1/2"	SF150-155
2"	SF200-155

2" COMPACT LP DISC-KLEEN FILTER

Automatic Self-Cleaning Disc Filter

APPLICATIONS

- Irrigation systems with a capacity of 1 to 80 GPM requiring clean water to operate emitters
- For areas without electricity
- When automation is desirable because manual cleaning is frequent and too cumbersome
- For residential, commercial, industrial, parks, municipal and non-potable water sources

SPECIFICATIONS

- Inlet: 2" male pipe threaded
- Outlet: 2" female pipe threaded
- Flush port: 2" female pipe threaded
- Maximum operating pressure:
Standard and low flow models: 90 psi
High pressure model: 140 psi
- Minimum pressure for backflush: 30 psi
- Minimum flow for backflush: Standard flow model: 35 GPM
Low flow model: 20 GPM
- Minimum allowable pH: 5
- Weight: 32 lbs.

MATERIALS

- Flush valves: plastic
- Seals: nitrilo rubber, EPDM
- Filter and spine: polypropylene
- Discs: polypropylene
- Clamp and screws: stainless steel

FEATURES & BENEFITS

PROVEN DISC TECHNOLOGY DEPTH FILTRATION

Provides highly effective filtering.

MADE OF NON-CORROSIVE MATERIALS

Prevents rusting and corrosion from chemicals and weather.

COMPACT PRE-ASSEMBLED UNIT FOR EASY INSTALLATION

Fits in tight spaces, saves space. Factory assembled and tested. Delivered ready for hook-up and immediate operation.

LESS BACKFLUSH TIME REQUIRED

Optimizes irrigation with a more uniform application of water.

INCLUDES BACKFLUSH CONTROLLER

AC model uses 110VAC power. DC model uses four D batteries.



STANDARD FLOW MODEL MAXIMUM FLOW RATE (GPM)

WATER QUALITY*	80 & 120 MESH	40 MESH
GOOD	80	50
AVERAGE	70	40
POOR	55	30
VERY POOR	35	20

LOW FLOW MODEL MAXIMUM FLOW RATE (GPM)

WATER QUALITY*	80 & 120 MESH	40 MESH
GOOD	50	40
AVERAGE	40	30
POOR	30	20
VERY POOR	20	10

*WATER QUALITY

GOOD WATER QUALITY:

Municipal water supply or well water from a clean aquifer with no sand, iron or manganese.

AVERAGE WATER QUALITY:

Wells with small amounts of sand (< 2 ppm) or clean surface water which includes lakes, ponds, reservoirs and canals.

POOR WATER QUALITY:

Well water with sand up to 10 ppm or surface water in hot climates with increased biological growth and no chemical treatment which includes lakes, ponds, reservoirs and canals.

VERY POOR WATER QUALITY:

Well water with greater than 10 ppm of sand including rivers, muddy canals, lakes and ponds with severe run off deposits and raw municipal wastewater.

GREATER THAN 3 PPM SAND OR SILT:

May require a pre-filter such as a hydrocyclone.

2" COMPACT LP DISC-KLEEN FILTER

Automatic Self-Cleaning Disc Filter

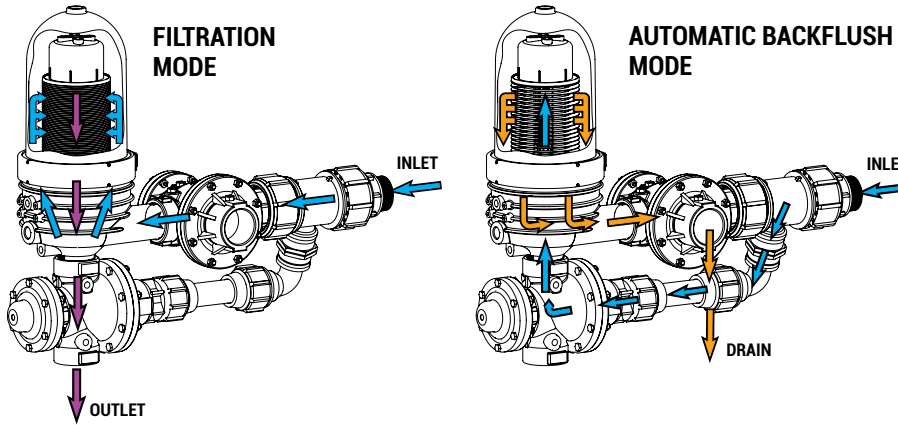

DISC FILTER TECHNOLOGY

Grooves in the disc rings criss-cross to form a network that traps debris between and on the outside of the discs.

HOW IT WORKS

As dirty water is pumped into the filter, and pressure increases, the water compresses the disc rings together tightly. The water is then forced to flow through the grooves of the disc rings, where debris is trapped, releasing only clean water to the irrigation system.

AUTOMATIC BACKFLUSH TECHNOLOGY

The discs separate and nozzles spray the discs with clean water - inside and out, removing debris.

FLOW RATE VS. PRESSURE LOSS

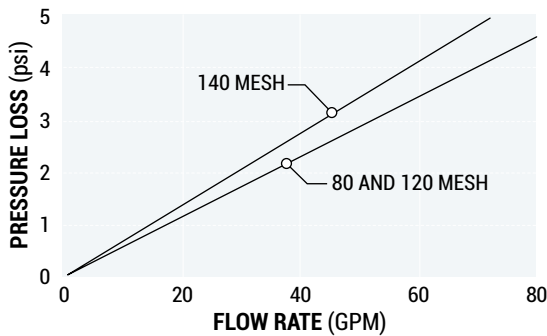

FLOW RATE VS. PRESSURE LOSS

FLOW RATES (GPM)	10	20	30	40	50	60	70	80
PRESSURE LOSS (psi)	0.2	0.5	1	1.4	2	3	4	5

120 mesh when filter is in a clean state.

ORDERING INFORMATION

DESCRIPTION	MESH	AC MODEL NUMBER	DC MODEL NUMBER
STANDARD FLOW MODEL 1-80 GPM 1-90 psi	80	DFALP200-080AC	DFALP200-080DCL
	120	DFALP200-120AC	DFALP200-120DCL
	140	DFALP200-140AC	DFALP200-140DCL
LOW FLOW MODEL 1-50 GPM 1-90 psi	80	DFALPLF200-080AC	DFALPLF200-080DCL
	120	DFALPLF200-120AC	DFALPLF200-120DCL
	140	DFALPLF200-140AC	DFALPLF200-140DCL

AC Models include installed backflush controller for 110VAC power supply.
DC Models include installed backflush controller with (4) D batteries and latching solenoids.

2" AND 3" LP DISC-KLEEN FILTER

Automatic Self-Cleaning Disc Filter

APPLICATIONS

- For surface water containing algae and other organic materials such as reservoirs, canals, rivers and wastewater applications
- Residential and multi-family developments
- Commercial landscapes, institutional parks, sports fields
- Golf courses
- Large landscape installations

SPECIFICATIONS

- 2" drain manifold inlet and outlet connections: grooved
- Backflush valve flush port: 2" MPT
- Maximum operating pressure:
Standard model: 90 psi High pressure model: 140 psi
- Minimum backflush pressure required:
Standard model: 30 psi High pressure model: 40 psi
- Minimum backflush flow rate:
2" filter: 35 GPM
3" filter: 70 GPM
- Minimum allowable pH: 5
- Inlet/outlet: 4" grooved - 2" Disc-Kleen
6" grooved - 3" Disc-Kleen
- Includes backflush controller

MATERIALS

- Manifold: polypropylene
- Filter body: polypropylene
- Discs: polypropylene
- O-Rings and Seals: EPDM

FEATURES & BENEFITS

PROVEN DEPTH FILTRATION

Collects debris along the depth of the discs, not just at the surface like screen filters.

MADE OF NON-CORROSIVE MATERIALS

Prevents rusting and corrosion from chemicals and weather.

QUICK INSTALLATION

Factory assembled and tested. Delivered ready for hook-up and immediate operation.

SMALL FOOTPRINT

Saves valuable space.

LESS BACKFLUSH TIME REQUIRED

Optimizes irrigation scheduling for uniform watering.



2" LP DISC-KLEEN FILTER
3-Unit



3" LP DISC-KLEEN FILTER
4-Unit

2" AND 3" LP DISC-KLEEN FILTER

Automatic Self-Cleaning Disc Filter

*WATER QUALITY

GOOD WATER QUALITY:

Municipal water supply or well water from a clean aquifer with no sand, iron or manganese.

AVERAGE WATER QUALITY:

Wells with small amounts of sand (< 2 ppm) or clean surface water which includes lakes, ponds, reservoirs and canals.

POOR WATER QUALITY:

Well water with sand up to 10 ppm or surface water in hot climates with increased biological growth and no chemical treatment which includes lakes, ponds, reservoirs and canals.

VERY POOR WATER QUALITY:

Well water with greater than 10 ppm of sand including rivers, muddy canals, lakes and ponds with severe run off deposits and raw municipal wastewater.

GREATER THAN 3 PPM SAND OR SILT:

May require a pre-filter such as a hydrocyclone.

FLOW RATE VS. PRESSURE LOSS

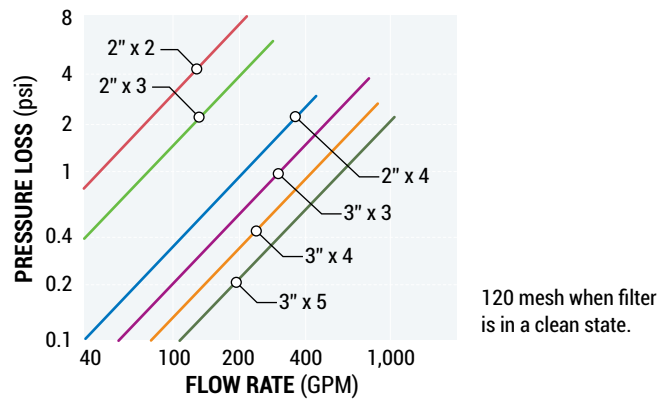

WATER QUALITY* MAXIMUM FLOW RATE (GPM)

MESH COLOR	YELLOW	RED	BLACK
MESH SIZE	80	120	140
MICRON SIZE	200	130	115

2" X 2 FILTER

GOOD	160	155	145
AVERAGE	150	140	130
POOR	130	120	90
VERY POOR	80	70	60

2" X 3 FILTER

GOOD	240	230	220
AVERAGE	225	210	195
POOR	195	180	135
VERY POOR	120	105	90

2" X 4 FILTER

GOOD	320	310	290
AVERAGE	300	280	260
POOR	260	240	180
VERY POOR	160	140	120

3" X 3 FILTER

GOOD	480	465	435
AVERAGE	450	420	390
POOR	380	340	270
VERY POOR	240	210	180

3" X 4 FILTER

GOOD	640	620	580
AVERAGE	600	560	500
POOR	500	450	340
VERY POOR	320	280	240

3" X 5 FILTER

GOOD	800	775	725
AVERAGE	750	700	600
POOR	650	525	400
VERY POOR	400	350	300

ORDERING INFORMATION

NUMBER OF FILTERS	MESH	MODEL NUMBER	NUMBER OF FILTERS	MESH	MODEL NUMBER
2" LP DISC-KLEEN			3" LP DISC-KLEEN		
2	80	DFALP202-080AC	3	80	DFALP303-080AC
	120	DFALP202-120AC		120	DFALP303-120AC
	140	DFALP202-140AC		140	DFALP303-140AC
3	80	DFALP203-080AC	4	80	DFALP304-080AC
	120	DFALP203-120AC		120	DFALP304-120AC
	140	DFALP203-140AC		140	DFALP304-140AC
4	80	DFALP204-080AC	5	80	DFALP305-080AC
	120	DFALP204-120AC		120	DFALP305-120AC
	140	DFALP204-140AC		140	DFALP305-140AC

AC Models include installed backflush controller for 110VAC power supply.

Solenoids are 24VAC.

Standard with PVC grooved x slip adapters and grooved couplings for connecting the filter to the main PVC line.

Backflush controllers are either 4 or 8 station depending on number of filters.

Maximum operating pressure - 90 psi.

High pressure model available for pressures between 91-140 psi.

APOLLO™ DISC-KLEEN FILTER

High Capacity Water Filtration System

APPLICATIONS

- For surface water containing algae and other organic materials such as reservoirs, canals, rivers and reclaimed water applications
- Residential and multi-family developments
- Commercial landscapes, institutional parks, sports fields
- Golf courses
- Large landscape installations

SPECIFICATIONS

- 4" drain manifold inlet/outlet connections: grooved
- Maximum operating pressures: Standard model: 90 psi High pressure model: 140 psi
- Minimum pressure required for backflush: 30 psi downstream of filters during backflush
- Maximum operating temperature: 158° F
- Minimum allowable pH: 5
- Minimum operating pressure for filtration: 20 psi
- Backflush flow rate @ 35 psi: 190 GPM
- Includes backflush controller

MATERIALS

- Manifold: high density polypropylene
- Filter body and cover: high density polypropylene
- Discs: polypropylene
- Backflush valve: nylon
- Clamps and bolts: polymeric

FEATURES & BENEFITS

PROVEN DEPTH FILTRATION

Collects debris along the depth of the discs, not just at the surface like screen filters.

MODULAR DESIGN

Provides even more portability as smaller units are assembled on-site to create larger filter units reducing installation costs.

WATER INLET AND OUTLET VERSATILITY

Multiple inlet and outlet configurations provide maximum flexibility.

MADE OF NON-CORROSIVE MATERIALS

Prevents rusting and corrosion from chemicals and weather.

QUICK INSTALLATION

Factory assembled and tested. Delivered ready for hook-up and immediate operation.

LESS BACKFLUSH TIME REQUIRED

Optimizes irrigation scheduling for uniform watering.

MORE FILTER AREA

Longer filters with larger discs. Saves money by reducing total number of filter units required.

LESS PRESSURE REQUIRED FOR CLEANING

Saves money by reducing pump size and energy costs.



APOLLO™ DISC-KLEEN FILTER

High Capacity Water Filtration System

FLOW RATE VS. PRESSURE LOSS

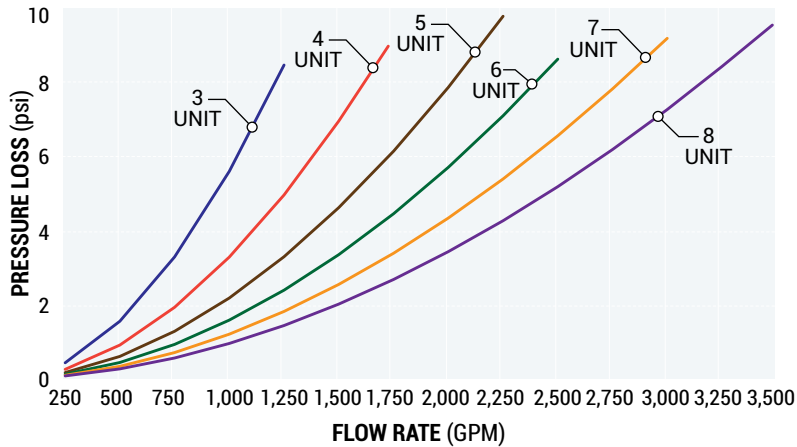

SPECIFICATIONS	4 UNIT ANGLE	3 UNIT TWIN	4 UNIT TWIN	5 UNIT TWIN	6 UNIT TWIN	7 UNIT TWIN	8 UNIT TWIN
STANDARD MODEL MAX. OPERATING PRESSURE (psi)	90	90	90	90	90	90	90
HIGH PRESSURE MODEL MAX. OPERATING PRESSURE (psi)	140	140	140	140	140	140	140
FILTRATION SURFACE AREA (sq. in.)	1,625	2,435	3,245	4,055	4,865	5,675	6,485
BACKFLUSH FLOW PER UNIT (GPM at 35 psi)	95	190	190	190	190	190	190
BACKFLUSH VOLUME PER FLUSH CYCLE (GPM)	130	210	265	340	420	500	550
INLET/OUTLET MANIFOLD CONNECTION (in.)	10 FL	10 FL	10 FL	10 FL	10 FL	10 FL	10 FL

MANIFOLD CONNECTION: FL = Flanged

ORDERING INFORMATION

NUMBER OF FILTERS	MESH	MODEL NUMBER	NUMBER OF FILTERS	MESH	MODEL NUMBER
4 ANGLE	80	DFAAP04A-080ACHP	6 TWIN	80	DFAAPM06-080ACHP
	120	DFAAP04A-120ACHP		120	DFAAPM06-120ACHP
	140	DFAAP04A-140ACHP		140	DFAAPM06-140ACHP
3 TWIN	80	DFAAPM03-080ACHP	7 TWIN	80	DFAAPM07-080ACHP
	120	DFAAPM03-120ACHP		120	DFAAPM07-120ACHP
	140	DFAAPM03-140ACHP		140	DFAAPM07-140ACHP
4 TWIN	80	DFAAPM04-080ACHP	8 TWIN	80	DFAAPM08-080ACHP
	120	DFAAPM04-120ACHP		120	DFAAPM08-120ACHP
	140	DFAAPM04-140ACHP		140	DFAAPM08-140ACHP
5 TWIN	80	DFAAPM05-080ACHP			
	120	DFAAPM05-120ACHP			
	140	DFAAPM05-140ACHP			

AC Models include installed backflush controller for 110VAC power supply.
Solenoids are 24VAC - other voltages available by special order.
Backflush controllers are either 4 or 8 station depending on number of filters.
Maximum operating pressure - 90 psi.

*WATER QUALITY

GOOD WATER QUALITY:

Municipal water supply or well water from a clean aquifer with no sand, iron or manganese.

AVERAGE WATER QUALITY:

Wells with small amounts of sand (< 2 ppm) or clean surface water which includes lakes, ponds, reservoirs and canals.

POOR WATER QUALITY:

Well water with sand up to 10 ppm or surface water in hot climates with increased biological growth and no chemical treatment which includes lakes, ponds, reservoirs and canals.

VERY POOR WATER QUALITY:

Well water with greater than 10 ppm of sand including rivers, muddy canals, lakes and ponds with severe run off deposits and raw municipal wastewater.

GREATER THAN 3 PPM SAND OR SILT:

May require a pre-filter such as a hydrocyclone.

MAXIMUM FLOW RATE (GPM)

WATER QUALITY*	FLOW PER SPINE		
	80 MESH	120 MESH	140 MESH
GOOD	198	183	171
AVERAGE	183	171	156
POOR	156	144	132
VERY POOR	132	117	105

CALCULATING MAXIMUM FLOW RATE (GPM) PER FILTER UNIT:

Take the total number of spines based on the filter size and multiple that number by the Flow Per Spine based on the Water Quality and Mesh.

SPINES PER FILTER

FILTER SIZE	NUMBER OF SPINES
4 UNIT ANGLE	4
3 UNIT TWIN	6
4 UNIT TWIN	8
5 UNIT TWIN	10
6 UNIT TWIN	12
7 UNIT TWIN	14
8 UNIT TWIN	16

HYDROMETERS

Combination Master Valve and Water Meter/Flow Sensor

APPLICATIONS

- For commercial, institutional and sports field irrigation applications
- Ideal for retrofits
- Designed for high pressure, remote operated applications
- Water meter can communicate with irrigation controllers and central control units
- Valve can function as a remote master valve for automated operation

SPECIFICATIONS

- Sizes: 1 1/2", 2", 3", 4", 6" and 8"
- Maximum working pressure:
Manual Electric - 235 psi
- Body: cast iron, polyester coated
- Valve diaphragm: reinforced natural rubber
- Pilot option: manual electric
- End connections: 1 1/2" - male pipe thread
2" - female pipe thread
3", 4", 6" 8" - flanged
- Flanges: drilled according to ANSI specification
- Standards: EEC approval (class A)
- Installation of a continuous acting air vent before the Hydrometer is highly recommended for accurate flow readings

FEATURES & BENEFITS

GLOBE CONFIGURATION WITH BUILT-IN STRAIGHTENING VANE

Requires no straight pipe for installation - saving space.

± 2% ACCURACY ACROSS FLOW RANGES

No more false alarms.

RUGGED, HEAVY DUTY CONSTRUCTION

Cast Iron with corrosion resistant coating.

REGISTERS ARE STAINLESS STEEL/COMPOSITE ENCAPSULATED

Guaranteed against fogging due to moisture.

DOUBLE-CHAMBERED VALVE

Provides quick acting and positive opening and closing.

SUB-METERING

Meter dedicated to landscape irrigation water.



1 1/2" AND 2"
(Threaded)



3" TO 8"
(Flanged)



REED SWITCH (RS) REGISTER

The reed switch register is a dry contact or simple switch closure for communicating with control and monitoring equipment. Flows are totaled in U.S. Gallons based on the multiplication factors indicated on the dial face.



PHOTO DIODE HIGH FREQUENCY (PDH) REGISTER

A photo coupler sensor that provides pulse output for communicating with control and monitoring equipment. Flows are totaled in U.S. Gallons based on the multiplication factors indicated on the dial face.



DIGITAL (ER) REGISTER

Combines standard digital register features with dry pulse output for communicating with control and monitoring equipment. Rate of flow and volume readings in U.S. Gallons are clearly indicated on the LCD display.

FRICTION LOSS vs. PRESSURE LOSS (psi)

		FLOW RATE (GPM)																												
		1.8	4.4	5.3	14	20	21	53	55	79	95	97	125	150	198	220	250	300	357	380	400	500	700	860	900	950	1000	1250	1500	
SIZE	1 1/2"	0.01	0.04	0.1	0.4	0.8	0.8	5.3	5.7																					
	2"			0.02	0.2	0.3	0.4	2.3	2.5	5.1	7.4	7.7																		
	3"				0.02	0.05	0.1	0.3	0.4	0.7	1.1	1.1	1.8	2.7	4.5	5.7														
	4"						0.02	0.1	0.2	0.3	0.5	0.5	0.8	1.2	2.0	2.5	3.2	4.7	6.6	7.5										
	6"							0.02	0.03	0.05	0.1	0.1	0.1	0.2	0.3	0.4	0.5	0.7	1.1	1.2	1.3	2.1	4.1	6.1						
	8"										0.02	0.02	0.04	0.1	0.1	0.1	0.2	0.2	0.3	0.4	0.4	0.6	1.3	1.9	2.1	2.3	2.6	4.0	5.8	

±2% Accuracy ±5% Accuracy

PERFORMANCE DATA (GPM)

SIZE	LOWEST FLOW WITHIN ± 5% ACCURACY	LOWEST FLOW WITHIN ± 2% ACCURACY	NOMINAL FLOW WITHIN ± 2% ACCURACY	MAXIMUM FLOW WITHIN ± 2% ACCURACY
1 1/2"	1.8	4.4	44	55
2"	5.3	20	66	95
3"	14	53	176	220
4"	21	79	264	380
6"	53	198	660	860
8"	97	357	1,189	1,500

ORDERING INFORMATION

METER SIZE	REGISTER OUTPUT TYPE	PULSE PER GALLON	GALLONS PER PULSE	MODEL NUMBER (MANUAL ELECTRIC)	METER SIZE	REGISTER OUTPUT TYPE	PULSE PER GALLON	GALLONS PER PULSE	MODEL NUMBER (MANUAL ELECTRIC)
1 1/2"	RS	1	1	LHM15TG1-MEL	4"	RS	1	1	LHM4FG1-MEL
	PDH	187.900	0.0053	LHM15TG0053-MEL		PDH	17.933	0.0566	LHM4FG0566-MEL
	ER	10	0.1	LHM15ERG0.1-MEL		ER	10	0.1	LHM4ERG1-MEL
2"	RS	1	1	LHM2TG1-MEL	6"	RS	0.1	10	LHM6FG10-MEL
	PDH	117.000	0.0085	LHM2TG0085-MEL		PDH	5.747	0.1741	LHM6FG1739-MEL
	ER	10	0.1	LHM2ERG.1-MEL		ER	1	1	LHM6ERG1-MEL
3"	RS	1	1	LHM3FG1-MEL	8"	RS	0.1	10	LHM8FG10-MEL
	PDH	48.710	0.0205	LHM3FG0205-MEL		PDH	3.152	0.317	LHM8FG317-MEL
	ER	10	0.1	LHM3ERG0.1-MEL		ER	1	1	LHM8ERG1-MEL

Netafim Hydrometers are standard in a manually closed configuration.

To order a Normally Open (NO) configuration, call Netafim Customer Service at 1 (888) 638-2346 for ordering information.

OCTAVE ULTRASONIC WATER METERS

Highly Accurate With No Moving Parts

APPLICATIONS

- Commercial applications
- Communicate with irrigation controllers and measures water usage for effective water management

SPECIFICATIONS

- Metal sizes: 2", 3", 4", 6", 8", 10" and 12"
- Metal body: epoxy-coated cast iron with flange inlet and outlet
- Flow range: < 1 GPM to 1,600 GPM
- Maximum working pressure: 230 psi
- Fluid temperature range: 32° to 122° F (0.1° to 50° C)
- Connections metal body: flanges ANSI ISO for AWWA connection standard
- Connections plastic: male pipe thread with ASTM couplers
- Environmental protection: IP-68, ambient operation temperature for display: -13° to 131° F (-25° - 55° C)
- Display units: multi-line, programmable 9 digit LCD display
- Output (optional): programmable single/dual open collector pulse output or externally powered 4-20 mA loop

FEATURES & BENEFITS

ACCURATE FLOW DATA WITHIN $\pm 1.5\%$

Double-beam ultrasonic sensors provide highly accurate flow data and reliable operation.

NO IMPELLER OR MOVING PARTS IN THE FLOW PATH

Ensures unrestricted low pressure loss flows.

LONG TERM PERFORMANCE

Lithium batteries provide a 10 year life expectancy.

Sealed and Tamper Proof IP68 Register

Programmed to log and display both forward and reverse flow.

Physically reversing the meter will not decrease the forward flow totalizer.

INSTANT INFORMATION READINGS

Flow and volume information, leak detection, flow direction, output mode, battery level, alarms and errors are viewable from a multi-readout screen.

UNIQUE SERIAL NUMBER AND ACCURACY CERTIFICATE

Each meter has its own unalterable barcoded serial number and includes a certificate verifying flow accuracy.

REDUCED MAINTENANCE

Requires less maintenance for wear-prone parts commonly found in other meters.



2" TO 12"
(Metal Body)

HOW OCTAVE WORKS

The Octave's measurement method is based on ultrasonic, transit-time, dual-beam sensors that determines the length of time it takes an ultrasonic wave to travel the distance between the two sensors located in the meter's body. The sensors function as both sender and receiver, each one alternating these functions so that the ultrasonic wave travels both with and against the direction of the flow. Because the ultrasonic wave travels slower against the flow than with the flow, the time difference of the two waves allows the meter to determine the flow rate.

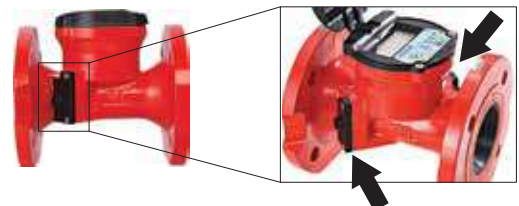

ULTRASONIC TRANSDUCERS
Double beam ultrasonic sensors

OCTAVE ULTRASONIC WATER METERS

PERFORMANCE DATA

SIZE	EXTENDED LOW FLOW WITHIN ± 5% (GPM)	NOMINAL FLOW RANGE WITHIN ± 5% (GPM)	SAFE MAX FLOW RATE (GPM)	HEADLOSS MAX FLOW RATE (psi)
1 1/2" PL	0.70	1.15 - 220	220	3.1
2" PL	0.35	0.50 - 220	250	3.1
2"	0.25	1 - 200	250	3.1
3"	0.50	1 - 500	400	6.9
4"	0.75	1 - 1,000	650	10.25
6"	2.0	3 - 1,400	1,500	6.05
8"	3.5	4.5 - 2,250	3,000	3.95
10"	8.8	14 - 5,500	5,500	1.75
12"	8.8	15 - 5,500	5,500	3.4

FLOW RATE VS. PRESSURE LOSS

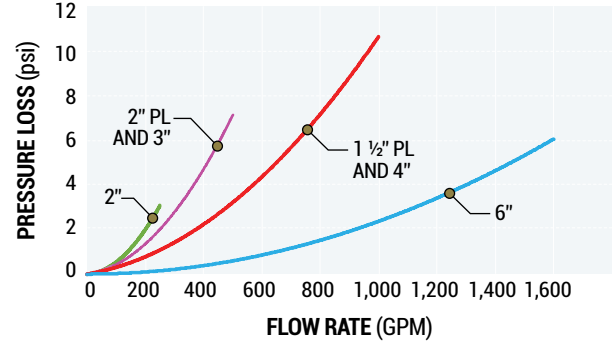

FLOW RATE VS. PRESSURE LOSS

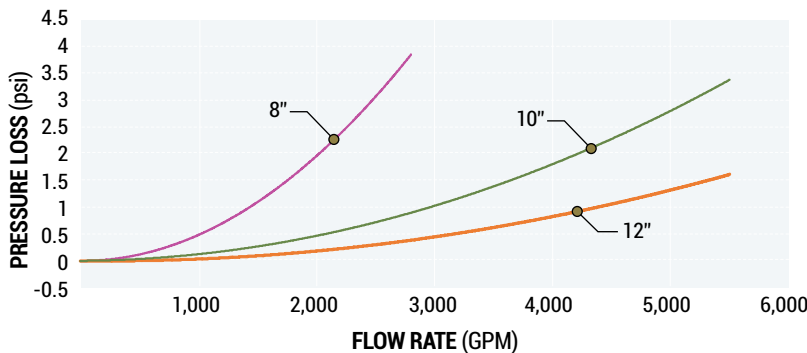

OCTAVE PROGRAMMING AND DIGITAL DISPLAY

Multi-line digital LCD readout display provides immediate reporting and visual indicators for critical conditions. The 9 digit display is easy to read at a glance. Each Octave meter will be pre-programmed before shipment for an instantaneous flow rate in gallons per minute (GPM) and volume totalizer units (Gallons).

NOTE: Programming software is not available to the end user. Once the meter is programmed by Netafim prior to shipment, it can only be reset by Netafim.

ORDERING INFORMATION

SIZE	OUTPUT
1 1/2" PL = 15TP	NO OUTPUT (METER DISPLAY ONLY) = NO
2" PL = 02TP	0.1 GALLONS PER PULSE = 0.1
2" = 02	1.0 GALLONS PER PULSE = 1.0
3" = 03	10 GALLONS PER PULSE = 10
4" = 04	100 GALLONS PER PULSE = 100
6" = 06	ANALOG OUTPUT 420mA = 420
8" = 08	
10" = 10	
12" = 12	

ORDERING EXAMPLE:

LS360CT04GAL0.1
4" Octave water meter, volume in gallons, flow rate in gallons per minute, pulse output 0.1 gallons per pulse

LS360CT SIZE GAL OUTPUT

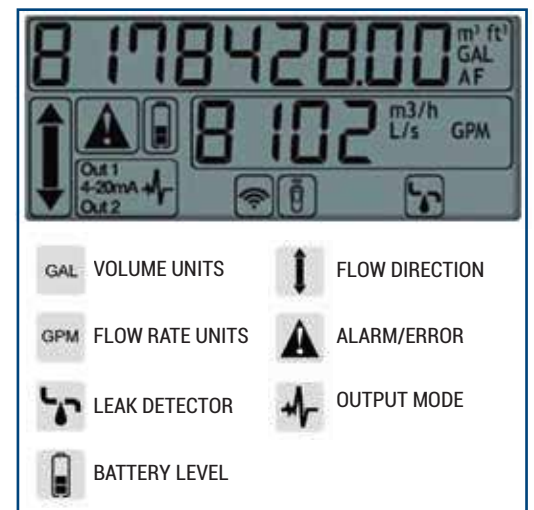

WATER METERS

Most Accurate in the Industry

APPLICATIONS

- Use smaller sized meters as sub-meter for residential or commercial applications
- Communicate with irrigation controllers and measures water usage for effective water management

SPECIFICATIONS

- Sizes: ¾" to 6"
- Maximum working pressure:
¾", 1" and 1 ½": 140 psi
2" to 6": 230 psi
- Maximum water liquid temperature:
¾", 1" and 1 ½": 122° F
131° F to 6": 140° F
- Available bodies: metal (corrosion proof copper alloy) or composite (plastic)
- Available with Reed Switch, Photo Diode or Electronic Digital registers
- Installation of a continuous acting air vent before the water meter is highly recommended for accurate flow readings

FEATURES & BENEFITS

ONLY ONE MOVING PART - THE IMPELLER - IN CONTACT WITH THE WATER

For minimum wear and utmost reliability.

MAGNETIC DRIVEN SEALED REGISTERS ARE STAINLESS STEEL/COMPOSITE ENCAPSULATED

Guaranteed against fogging due to moisture.

ACCURATE OVER A WIDE RANGE OF FLOWS

For flexible and efficient water management.

INDUSTRY'S LONGEST WARRANTY

Three years on the metering components (register and metering assembly) and five years on the meter body.



¾" AND 1"
(Plastic Body)



¾", 1" AND 1 ½"
(Metal Body)



2"



3", 4" AND 6"

PERFORMANCE DATA (GPM)

SIZE	LOWEST FLOW WITHIN ± 5% ACCURACY	LOWEST FLOW WITHIN ± 2% ACCURACY	NOMINAL FLOW WITHIN ± 2% ACCURACY	MAXIMUM FLOW WITHIN ± 2% ACCURACY
¾"	0.2	0.9	11	14
1"	0.3	1.2	15.4	20
1 ½"	0.9	3.5	44	55
2"	2.0	8.8	88	110
3"	2.0	4	528	660
4"	4.0	6	1,013	1,266
6"	11	15	1,145	1,431

FLOW RATE VS. PRESSURE LOSS

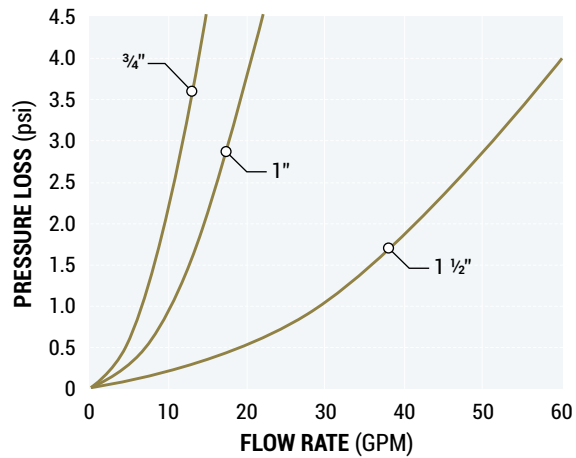

FLOW RATE VS. PRESSURE LOSS

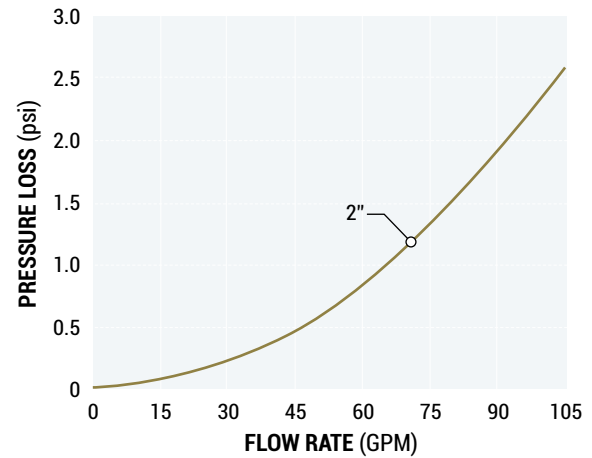

FLOW RATE VS. PRESSURE LOSS

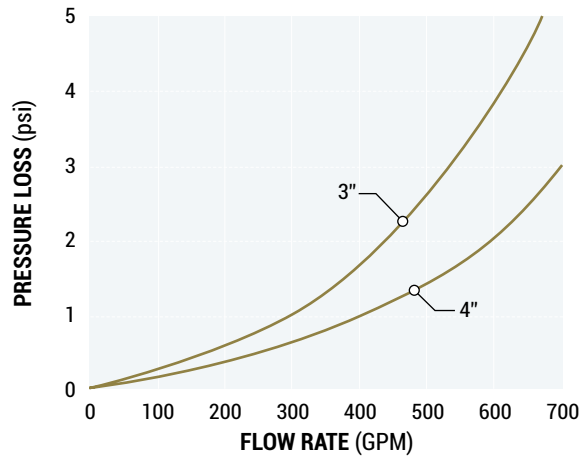

FLOW RATE VS. PRESSURE LOSS

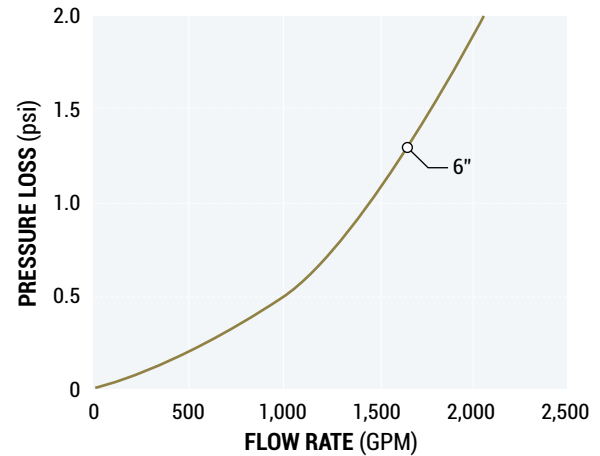

WATER METERS



REED SWITCH REGISTER (RS)

The reed switch register is a dry contact or simple switch closure for communicating with control and monitoring equipment. Flows are totaled in U.S. Gallons based on the multiplication factors indicated on the dial face.

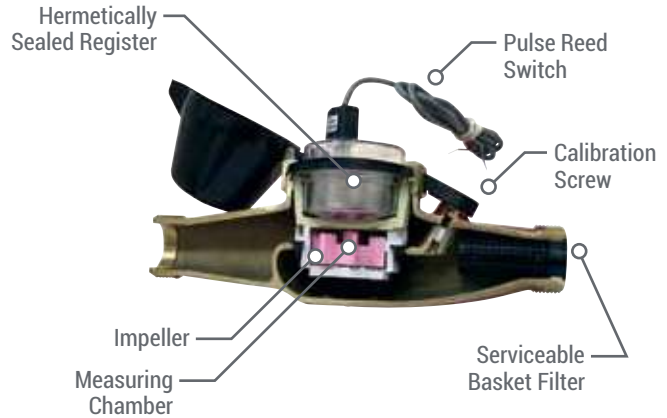

PHOTO DIODE REGISTER (PD)

A photo coupler sensor that provides pulse output for communicating with control and monitoring equipment. Flows are totaled in U.S. Gallons based on the multiplication factors indicated on the dial face.



DIGITAL (ER) REGISTER

Combines standard digital register features with dry pulse output for communicating with control and monitoring equipment. Rate of flow and volume readings in U.S. Gallons are clearly displayed on the LCD display.

ORDERING INFORMATION

BODY MATERIAL	SIZE	REGISTER OUTPUT TYPE	GALLONS PER PULSE	MODEL NUMBER
PLASTIC	3/4"	RS	0.1	WM-075-0.1-RS-P
PLASTIC	3/4"	RS	1.0	WM-075-1.0-RS-P
PLASTIC	1"	RS	1.0	WM-100-1.0-RS-P
PLASTIC	3/4"	PD	.0015	WM-075-.0015-PD-P
PLASTIC	1"	PD	.0021	WM-100-.0021-PD-P
PLASTIC	3/4"	ER	0.1	WM-075-0.1-ER-P
PLASTIC	1"	ER	0.1	WM-100-0.1-ER-P
METAL	3/4"	RS	0.1	WM-075-0.1-RS-M
METAL	3/4"	RS	1.0	WM-075-1.0-RS-M
METAL	1"	RS	1.0	WM-100-1.0-RS-M
METAL	1 1/2"	RS	1.0	WM-150-1.0-RS
METAL	2"	RS	10	WM-200-10-RS
METAL	3"	RS	10	WMW-300-10-RS
METAL	4"	RS	10	WMW-400-10-RS
METAL	6"	RS	100	WMW-600-100-RS
METAL	3/4"	PD	.0015	WM-075-.0015-PD-M
METAL	1"	PD	.0021	WM-100-.0021-PD-M
METAL	1 1/2"	PD	.0074	WM-150-.0074-PD
METAL	2"	PD	1.0	WM-200-1.0-PD
METAL	3/4"	ER	0.1	WM-075-0.1-ER-M
METAL	1"	ER	0.1	WM-100-0.1-ER-M
METAL	1 1/2"	ER	0.1	WM-150-0.1-ER
METAL	2"	ER	1.0	WM-200-1.0-ER
METAL	3"	ER	1.0	WMW-300-1.0-ER
METAL	4"	ER	1.0	WMW-400-1.0-ER
METAL	6"	ER	10	WMW-600-10-ER

STRAIGHT PIPE INSTALLATION

REQUIRED FOR WATER METERS 2" AND LARGER

When water flows through a pipe, any transition through a fitting, elbow, or change in pipe size causes turbulence in the water. In order to eliminate water turbulence, some water meters require straight pipe before and after the water meter. Straight pipe installation refers to the length of straight pipe needed before (upstream of the water meter) and after (downstream of the water meter).

The ¾", 1" and 1 ½" water meters do not require straight pipe installation, but a 5 x diameter before and 2 x diameter straight pipe installation after the meter is recommended. **(Diameter = Meter Size)**

The 2" water meter requires straight pipe installation of 10 x diameter before and 5 x diameter straight pipe installation after the meter.

The 3", 4" and 6" water meters require straight pipe installation of 5 x diameter before and 2 x diameter straight pipe installation after the meter.

Continuous acting air vents are used to remove air from the system for accurate metering. Proper air vent selection and placement within the system is critical.

CONFIGURING STRAIGHT PIPE INSTALLATION EXAMPLE BELOW:

Water Meter: 2"

Upstream: 10 x 2" diameter meter = 20" (10 x D)
20" of straight pipe upstream of the water meter

Downstream: 5 x 2" diameter meter = 10" (5 x D)
10" of straight pipe downstream of the water meter

Meter Length: 14"

Total: 44" total installation recommended

STRAIGHT PIPE INSTALLATION REQUIREMENTS

(10 x D and 5 x D - 2" Size)
(5 x D and 2 x D - 3", 4" and 6" Size)

SIZE	UPSTREAM DISTANCE	DOWNSTREAM DISTANCE	METER LENGTH	TOTAL REQUIREMENT
2"	20"	10"	14"	44"
3"	15"	6"	9"	30"
4"	20"	8"	10"	38"
6"	30"	12"	12"	54"

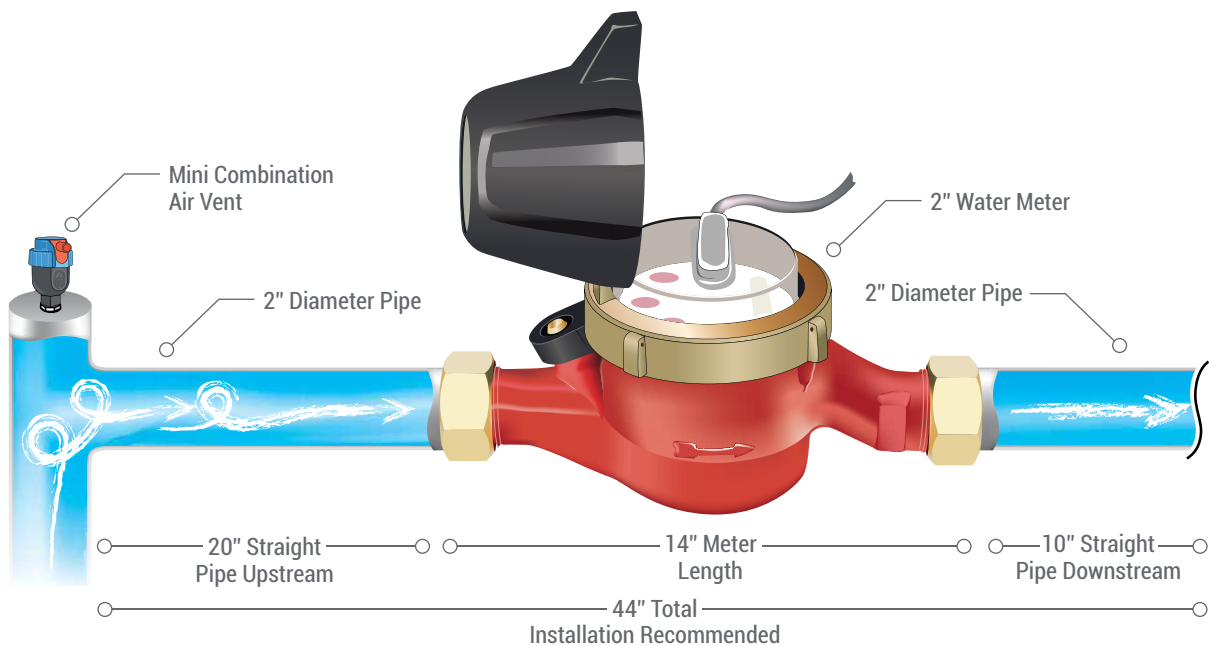

POINT SOURCE DESIGN

IRRIGATING TREES, SHRUBS AND NATIVE PLANTS

For trees, shrubs and native plants with wide and/or random spacing requirements, point source drip irrigation is the perfect alternative. In landscape areas that are sparsely planted, irrigating within the plant's canopy conserves water and inhibits weed growth in the areas with no plants. Depending on the plant's canopy size and soil type, the number of point source emitters can be easily determined.

SIMPLIFIED DRIP DESIGN GRAPH

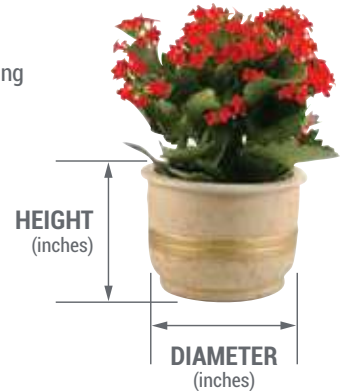
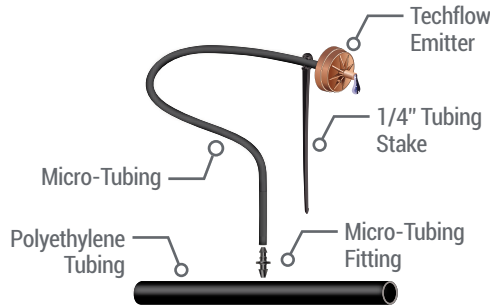
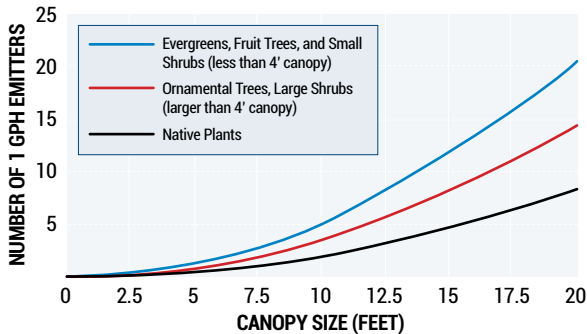

APPROXIMATE WETTED DIAMETER and WETTED AREA PER EMITTER (PER SOIL TYPE)

EMITTER FLOW RATE	WETTED DIAMETER PER EMITTER (FT.)			WETTED AREA PER EMITTER (SQ. FT.)		
	CLAY SOIL	LOAM SOIL	SANDY SOIL	CLAY SOIL	LOAM SOIL	SANDY SOIL
0.5 GPH	5 - 7	3 - 5	2 - 3	20 - 38	7 - 20	3 - 7
1.0 GPH	7 - 8	5 - 6	3 - 3.5	38 - 50	20 - 28	7 - 10
2.0 GPH	8 - 9	6 - 7	3.5 - 4	50 - 64	28 - 38	10 - 13

Emitter flow rates have an impact on the soil's ability to absorb water. The lighter the shaded box indicates the more desirable flow rate given the soil selection.

$$\text{Container Size (gallons)} = \frac{\text{Surface Area} = \text{Diameter (m.)} \times 0.7854 \times \text{Surface Area (sq. in.)} \times \text{Height (inches)}}{231}$$

$$\text{Number of Emitters per Plant} = \frac{\text{Plant Canopy (square feet)} \times 0.75}{\text{Wetted Area per Emitter (square feet)}}$$

For example:

- Tree with 16' canopy in a loam soil.
- Plant root zone = $(16')^2 \times 0.7854 = 256 \times 0.7854 = 201$ square feet.
- Number of 1.0 GPH emitters required = $201 \times .75/24 = 150.8/24 = 6.28 = 6 - 1.0$ GPH emitters.

CONTAINER IRRIGATION (FREQUENCY)

CLIMATE	SANDY SOIL	LOAM SOIL	CLAY SOIL	POTTING SOIL
VERY COOL	2 DAYS	3 DAYS	8 DAYS	2 DAYS
COOL	1 ½ DAYS	2 DAYS	6 DAYS	DAILY
MODERATE	1 ½ DAYS	2 DAYS	6 DAYS	DAILY
HOT	DAILY	2 DAYS	5 DAYS	DAILY
HIGH DESERT	DAILY	1 ½ DAYS	4 DAYS	DAILY
LOW DESERT	DAILY	DAILY	3 DAYS	DAILY

IRRIGATION DURATION

CLIMATE	RUN TIME (HOURS)
VERY COOL	1.3
COOL	2.6
MODERATE	3.5
HOT	4.2
HIGH DESERT	5.1
LOW DESERT	5.9

CONTAINER IRRIGATION (EMITTER FLOW RATE and RUN TIME)

CONTAINER SIZE (GALLONS)	EMITTER FLOW (GPH)	SANDY SOIL (IN MIN.)	LOAM SOIL (IN MIN.)	CLAY SOIL (IN MIN.)	POTTING SOIL (IN MIN.)
1	0.5	3	5	11	2
2	0.5	6	10	20	4
5	1.0	9	15	30	6
15	1.0	25	40	90	18
25	1.0	40	75	150	35

SELF-PIERCING EMITTERS

With Check Valve

APPLICATIONS

- For use with blank polyethylene tubing, Techline Copper, CV, DL and RW/RWP
- Install on-surface or subsurface
- Wide-spaced plantings
- Tree planting
- Hanging baskets
- Flower boxes
- Planters or pots

SPECIFICATIONS

- Flow rates: 0.5, 1.0 and 2.0 GPH
- Pressure compensation range: 10.2 to 58 psi
- Maximum pressure: 58 psi
- Uses 0.160" x 0.220" micro-tubing (Model EDTUBE - in black or white)
- Barb size: Inlet 0.160" - 0.170"
Outlet 0.160"
- Recommended minimum filtration: 120 mesh

FEATURES & BENEFITS

SELF-PIERCING BARB

Easy to install, no tools required. Optional insertion tool available.

1.7 PSI INTERNAL CHECK VALVE

Helps prevent low emitter drainage holding back up to a 3.9' column of water. Can be used with Techline Copper and CV Dripline.

ANTI-SIPHON OPERATION

Prevents contaminants from being drawn into the emitter.

PRESSURE COMPENSATING

Delivers the same flow from 10.2 to 58 psi.

SELF-CLEANING ACTION

Exclusive TurboNet® flow path design regulates flow and provides continuous self-cleaning action during operation.



FLOW RATE VS. PRESSURE LOSS

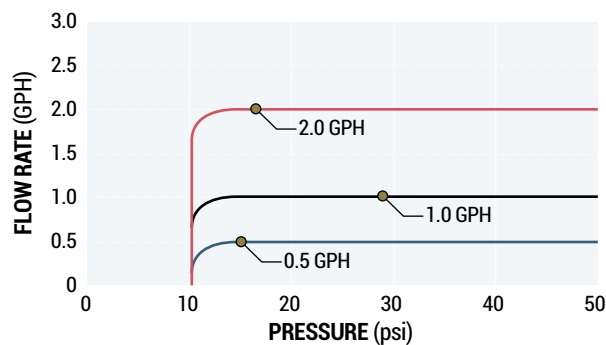

ORDERING INFORMATION

FLOW RATE	COLOR	BAG QUANTITY	MODEL NUMBER
0.5 GPH	BLUE	25	SPCV05-25
		100	SPCV05-100
		250	SPCV05-250
		1,000	SPCV05-1000
1.0 GPH	BLACK	25	SPCV10-25
		100	SPCV10-100
		250	SPCV10-250
		1,000	SPCV10-1000
2.0 GPH	RED	25	SPCV20-25
		100	SPCV20-100
		250	SPCV20-250
		1,000	SPCV20-1000

TECHFLOW EMITTERS

Pressure Compensating Emitters

APPLICATIONS

- For use with systems with a wide range of pressure variations (14.5 to 58 psi)
- Install on-surface or subsurface
- Wide range of plant spacings
- Hanging baskets, flower baskets, pots, interiorscapes

SPECIFICATIONS

- Flow rates: 0.5, 1.0 and 2.25 GPH
- Pressure compensation range: 14.5 to 58 psi
- Maximum pressure: 58 psi
- Uses 0.160" x 0.220" micro-tubing (Model EDTUBE - in black or white)
- Barb size: Inlet 0.160" - 0.170", Outlet 0.160"
- Recommended minimum filtration: 120 mesh

FEATURES & BENEFITS

UNIQUE EMITTER DESIGN

Regulates flow and provides continuous self-cleaning action during operation.

2.2 PSI INTERNAL CHECK VALVE

Helps prevent low emitter drainage by holding back up to a 5' column of water.

ANTI-SIPHON OPERATION

Prevents contaminants from being drawn into emitter.

COLOR-CODED EMITTER

Denotes flow rate.

CAN BE USED WITH TECHLINE HCVXR AND CV DRIPLINE

Without causing dripline drainage.



ORDERING INFORMATION (Barb Inlet x Nipple Outlet)

FLOW RATE	COLOR	BAG QUANTITY	MODEL NUMBER
0.5 GPH	RED	25	WPC5
		250	WPC5-250
1.0 GPH	BLACK	25	WPC10
		250	WPC10-250
2.25 GPH	GREEN	25	WPC20
		250	WPC20-250
BUG CAP		25	WPBC
BARBED ADAPTER		25	11WPCON47-B

FLOW RATE VS. PRESSURE LOSS

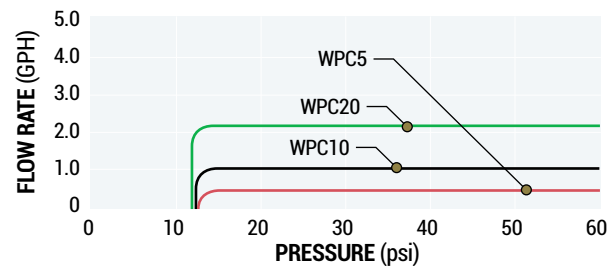

BD and WP EMITTERS

Non-Pressure Compensating Emitters

APPLICATIONS

- Use in piping networks with limited pressure variation
- Planters and pots
- Wide-spaced plantings

SPECIFICATIONS

- Flow rates: 0.5, 1.0 and 2.0 GPH
- BD and WP models use 0.160" x 0.220" micro-tubing (Model EDTUBE)
- Barb size: Inlet 0.160" - 0.170", Outlet 0.160"
- Maximum pressure: 29 psi
- Recommended minimum filtration: 120 mesh

FEATURES & BENEFITS

WIDE TURBULENT FLOW PASSAGE

Resists clogging and works well in low pressure applications.

BARB INLET

For easier installations.

COLOR-CODED EMITTER

Denotes flow rate.

FLOW RATE VS. PRESSURE LOSS

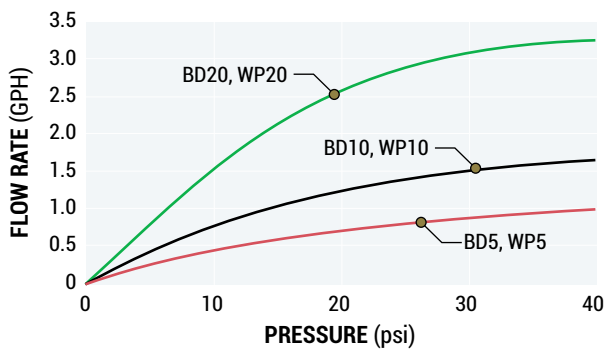

BD EMITTERS ORDERING INFORMATION

FLOW RATE	COLOR	BAG QUANTITY	MODEL NUMBER
0.5 GPH	RED	25	BD5
		250	BD5-250
1.0 GPH	BLACK	25	BD10
		250	BD10-250
2.0 GPH	GREEN	25	BD20
		250	BD20-250

WP EMITTERS ORDERING INFORMATION

FLOW RATE	COLOR	BAG QUANTITY	MODEL NUMBER
0.5 GPH	RED	25	WP5
		250	WP5-250
1.0 GPH	BLACK	25	WP10
		250	WP10-250
2.0 GPH	GREEN	25	WP20
		250	WP20-250

NETBOW™

Irrigation Ring

UNIFORM WATER DISTRIBUTION

An innovative user-friendly container irrigation ring with multi-outlet emitters. Featuring Typhoon™, our superior clog resistant emitter for maximum water distribution. Specially designed for irrigating containerized crops.



FEATURES & BENEFITS

SUPERIOR CLOG RESISTANCE

Use with Netafim Typhoon™ emitter.

SPECIALLY DESIGNED MICRO-TUBING

Evenly spaced emitters for higher distribution uniformity.

UNIFORM SURFACE WETTING

Provides optimal rootzone development.

QUICK ACTION INSTALLATION

Place ring in the container, then connect the pre-cut micro tubing.

PATENTED

NetBow™ is patented by U.S. Design App. No. 29/709,373.

MULTIPLE CONNECTION OPTIONS

Connect to hub drippers: Techflow, PVC or PC

or by using Dr. Zip™ with the Techline™ family of products or Uniram™.

*Barbed adapter or elbow is needed for assembly with Techflow, PCJ and PC emitters.

APPLICATIONS

- Install on-surface or under mulched areas
- Wide spaced plantings
- Tree planting
- Flower boxes
- Planters or pots

SPECIFICATIONS

- Diameter: 10" (250mm)
5" (125mm)
- 10" Flow Rate: 8 emitter outlets with flow of 0.53 GPH each at 14.5 psi
- 5" Flow Rate: 4 emitter outlets with flow of 0.53 GPH each at 14.5 psi
- The flow from each emitter outlet will be determined by the hub dripper, based on the pressure developed in the NetBow inlet.
- We recommend that the flow of the hub dripper to be 0.53-2.11 GPH. If your flow is out of this determined range please follow Netafim guidelines for on-line emitter design.
- Chemical and UV resistance for durability
- Colored light gray for improved light reflection
- Max. operating pressure for hub drippers - 58.0 psi

HUB DRIPPER FLOW RATES (GPM)

TECHFLOW	PC	PC LCNL	PCJ	PCJ LCNL	TECHLINE / UNIRAM
0.53	0.53	0.53	0.53	0.53	0.61
1.06	1.06	1.06	0.79	0.79	0.92
2.25	2.25	2.25	1.06	1.06	
			2.11	2.11	
			3.17	3.17	

NETBOW & ASSEMBLY

MODEL NUMBER	DESCRIPTION	QTY. PER CARTON (UNITS)
NETBOW5F-CART	NETBOW 5" 4 OUTLETS / BARB INLET / FOLDABLE LEGS	120
NETBOW10-CART	NETBOW 10" 8 OUTLETS / BARB	60
NETBOW10-18	NETBOW 10" 8 OUTLETS / BARB BLACK PE TUBING 18"	60
NETBOW10-18WH	NETBOW 10" 8 OUTLETS / BARB WHITE PE TUBING 18"	60
NETBOW10-24WH	NETBOW 10" 8 OUTLETS / BARB WHITE PE TUBING 24"	60
NETBOW10-30WH	NETBOW 10" 8 OUTLETS / BARB WHITE PE TUBING 30"	60
NETBOW10-36WH	NETBOW 10" 8 OUTLETS / BARB WHITE PE TUBING 36"	60
NETBOW10-18WH-DRZ	NETBOW 10" 8 OUTLETS / BARB WHITE PE TUBING 18" WITH DR. ZIP	60

ASSEMBLY COMPONENTS

MODEL NUMBER	DESCRIPTION	QTY. PER BAG/PACK
11002520-B	5 MM ELBOW	50
11WPCON-B	3 MM FLEX TUBE ADAPTER (FOR NIPPLE OUTLET DRIPPERS)	250
15FPEW53-18	18" PRE-CUT SUPER FLEX UV WHITE PE TUBING (5/3 MM)	100
15FPEW53-24	24" PRE-CUT SUPER FLEX UV WHITE PE TUBING (5/3 MM)	100
15FPEW53-30	30" PRE-CUT SUPER FLEX UV WHITE PE TUBING (5/3 MM)	100
15FPEW53-36	36" PRE-CUT SUPER FLEX UV WHITE PE TUBING (5/3 MM)	100

*Other assembly components are available. Please contact your Netafim representative for more information.

DR. ZIP

DR. ZIP

A reliable dripline to micro-tube adapter for Techline, Uniram & NetBow applications.



APPLICATIONS

- Easy to install & connect to micro-tube/manifold
- Flexible to wrap any pipe shape for a tight seal
- Can be used to prevent draining along laterals
- Compatible with heavywall driplines 45 mil. thickness or higher - Techline, UniRam™, DripNet PC™ and Aries™
Note: unsuitable for Aries™ driplines with flow rates of ≥ 1.0 gph.
- Chemical and UV resistant for extended durability
- Barbed adapter or elbow is needed for assembly with Dr. Zip.

DR. ZIP

ITEM NUMBER	QTY. PER BAG/PACK
32000-010960	1000
32000-010961	50
32000-010962	100

POLYETHYLENE TUBING

APPLICATIONS

- For use with point source drip emitters, micro-spray or micro-sprinklers for irrigating ground cover, trees and shrub beds
- Provides flexible and durable header or transition to dripline
- For on-surface or subsurface installations
- Positions on-line emission devices in hard to reach places

FEATURES & BENEFITS

SPEEDS INSTALLATION OF DRIP IRRIGATION SYSTEM

Allows for fast connections and easy layouts.

UV RESISTANT

Withstands heat, direct sun and harsh environments.

MANUFACTURED UNDER STRINGENT QUALITY CONTROLS

Assures highest quality as every coil undergoes a battery of tests and over 30 quality checks.

MADE WITH THE FINEST LOW DENSITY POLYETHYLENE RESIN AVAILABLE

Available in black or bright white.



BLACK POLYETHYLENE
1,000' Coil



BRIGHT WHITE POLYETHYLENE
1,000' Coil



ORDERING INFORMATION

DESCRIPTION	PRESSURE RATING (PSI)	COIL LENGTH	MODEL NUMBER
BLACK POLYETHYLENE TUBING			
16MM O.D. (0.520" X 0.620", 0.050" WALL)	70	250'	PE052062-25
		500'	PE052062-05
		1,000'	PE052062-10
½" (0.620" X 0.710", 0.045" WALL)	52	500'	PE062071-05
		1,000'	PE062071-10
½" (0.600" X 0.700", 0.050" WALL)	61	250'	PE060070-25
		500'	PE060070-05
		1,000'	PE060070-10
¾" (0.820" X 0.940", 0.060" WALL)	54	500'	PE082094-05
		1,000'	PE082094-10
1" (1.060" X 1.200", 0.070" WALL)	49	500'	PE106120-05
BRIGHT WHITE POLYETHYLENE TUBING			
16MM O.D. (0.520" X 0.620", 0.050" WALL)	70	500'	PE052062-05BW
		1,000'	PE052062-10BW
½" (0.600" X 0.700", 0.050" WALL)	61	500'	PE060070-05BW
		1,000'	PE060070-10BW
¾" (0.820" X 0.940", 0.060" WALL)	54	500'	PE082094-05BW
1" (1.060" X 1.200", 0.070" WALL)	49	500'	PE106120-05BW

APPLICATIONS

- For extending the drip emitter outlet/discharge close to a tree or shrub
- For use with point source drip emitters on trees, shrub beds, potted plants and hanging baskets

SPECIFICATIONS

- ¼" (4/6mm) EDTUBE Black: 0.160" ID, 0.220" OD, 0.030" wall 100' or 1,000' lengths
- ¼" (4/7mm) EDTUBE White: 0.156" ID, 0.264" OD, 0.054" wall 100' or 1,000' lengths

FITTINGS APPLICATIONS

- Fits all models of 1/4" tubing with inside diameter of 0.160" or 0.156"

FEATURES & BENEFITS

UV AND ACID RESISTANT POLYETHYLENE RESIN MATERIALS

Withstands hot and cold weather better than vinyl. Provides excellent hold characteristics on point source drip emitter barbed outlets and fittings in any kind of weather.

MANUFACTURED UNDER STRINGENT QUALITY CONTROLS

Assures highest quality product as every coil undergoes a battery of tests and over 30 quality checks.

WIDE COMPATIBILITY

Compatible with all brands and models of point source emitters that accept ¼" (0.160" ID) micro-tubing.

WHITE PE TUBING IS REFLECTIVE AND OPAQUE

Prevents algae growth. Produces cooler water temperatures - enhancing plant growth.

FITTINGS FEATURES & BENEFITS

BARBED FITTINGS

For secure fit and easy installation without clamps, glue or tools.

UV-RESISTANT

Withstands heat, direct sunlight and harsh chemicals.

WIDE COMPATIBILITY

Compatible with all brands and models of ¼" micro-tubing.

ORDERING INFORMATION

COIL LENGTH	MODEL NUMBER
BLACK - 0.160" x 0.220"	
100'	EDTUBE-01
1,000'	EDTUBE-10
WHITE - 0.156" x 0.264"	
100'	EDTUBE-01W
1,000'	EDTUBE-10W

FRICTION LOSS PER 100 FEET

NOMINAL SIZE		1/4" EDTUBE BLACK		1/4" EDTUBE WHITE	
FLOW RATE		0.160" I.D. 0.220" O.D. 0.030" WALL		0.156" I.D. 0.264" O.D. 0.054" WALL	
GPM	GPM	VELOCITY FPS	LOSS PSI	VELOCITY FPS	LOSS PSI
0.01	0.50	0.13	0.08	0.14	0.09
0.02	1.00	0.27	0.27	0.28	0.31
0.03	2.00	0.53	0.92	0.56	1.04
0.05	3.00	0.80	1.87	0.84	2.11
0.07	4.00	1.06	3.09	1.12	3.49
0.08	5.00	1.33	4.57	1.40	5.16
0.10	6.00	1.60	6.29	1.68	7.10
0.12	7.00	1.86	8.24	1.96	9.29
0.13	8.00	2.13	10.40	2.24	11.74
0.15	9.00	2.39	12.79	2.52	14.43
0.17	10.00	2.66	15.38	2.80	17.35
0.20	12.00	3.19	21.15	3.36	23.87
0.23	14.00	3.72	27.70	3.92	31.26
0.27	16.00	4.26	35.00	4.48	39.49
0.30	18.00	4.79	43.01	5.04	48.53
0.33	20.00	5.32	51.72	5.60	58.36



WHITE TUBING
1,000' Coil



BLACK TUBING
1,000' Coil

MICRO-TUBE ACCESSORIES

APPLICATIONS

- Fits all models of 1/4" tubing with inside diameter of 0.160" or 0.156"

FEATURES & BENEFITS

BARBED FITTINGS

For secure fit and easy installation without clamps, glue or tools.

UV-RESISTANT

Withstands heat, direct sunlight and harsh chemicals.

WIDE COMPATIBILITY

Compatible with all brands and models of 1/4" micro-tubing.

FITTINGS



1/4" BARB TEE
(0.160")
Model EDTUBETEE



1/4" MICRO-VALVE
(0.160")
Model EDTUBEMVLV-B



1/4" BARB ADAPTER/COUPLER
(0.160")
Model EDTUBEBA



1/4" TUBING STAKE
Model EDTUBESTK



1/4" / 3/8" GOOF PLUG
(0.160" / 0.230")
Model GOOFPLU



1/4" BARBED 8-WAY X 1/2" MPT ADAPTER
(0.160") for EDTUBE
Model EDTUBE8XMTG

INSTALLATION TOOLS



STEEL PUNCH FOR 0.160" MICRO FITTINGS
Model MTUBESPUN



PLASTIC HANDLE PUNCH FOR 0.160" MICRO FITTINGS
Model MTUBEPPUN



INSERTION TOOL FOR SELF-PIERCING EMITTERS
Model SPDT

FORMULA 1.1

Estimated Total Length of Dripline =

$$\frac{\text{Irrigated Area} \times 12}{\text{Minimum Recommended Lateral Spacing (inches)}}$$

In Which:

Estimated Total Length of Dripline =
Total Footage of Dripline in a Zone
Irrigated Area = Total Area in Square Feet
Minimum Recommended Lateral (Row) Spacing =
The minimum row spacing from the
General Guidelines Chart in inches

FORMULA 1.2

Application Rate =

$$\frac{231.1 \times \text{Emitter Flow Rate (GPH)}}{\text{Dripline Row Spacing (inches)} \times \text{Emitter Spacing (inches)}}$$

In Which:

Application Rate is = Inches per Hour of Water Being Applied
Emitter Flow Rate = Gallons per Hour Flow of One Emitter
Emitter Spacing = Spacing in Inches of Emitters Inside Tubing
Dripline Row Spacing = Inches Between Techline Laterals (rows)

FORMULA 1.3

Number of Emitters in a Zone =

$$\frac{\text{Total Dripline} \times 12}{\text{Emitter Spacing (inches)}}$$

In Which:

Number of Emitters = Number of Emitters
Total Dripline = Length of All Dripline in a Zone in Feet
Emitter Spacing = Spacing in Inches of Emitters Inside Tubing

FORMULA 1.4

Flow per Zone =

$$\frac{\text{Number of Emitters} \times \text{Emitter Flow Rate (GPM)}}{60}$$

In Which:

Flow Per Zone = Total Gallons per Minute
Number of Emitters = Number of Emitters
Emitter Flow Rate = Gallons per Hour of One Emitter

FORMULA 1.5

Estimated Total Zone Flow =

$$\left\{ \frac{\text{Irrigated Area} \times 144}{\text{Emitter Spacing (inches)} \times \text{Dripline Row Spacing (inches)}} \right\}$$

In Which:

Estimated Total Zone Flow = Gallons per Minute in Zone
Irrigated Area = Total Area in Square Feet
Emitter Spacing = Spacing in Inches of Emitters Inside Tubing
Dripline Row Spacing = Inches Between Techline Laterals (rows)
Emitter Flow Rate = Gallons per Hour of One Emitter

FORMULA 1.6

Estimated Run Time =

$$\frac{\text{Daily Et (inches)}}{\text{Application Rate (inches per hour)}}$$

In Which:

Estimated Run Time = Estimated Number of minutes of run time for a particular zone (based upon input data)
Et = Evapotranspiration; The amount of water released from soil by evaporation and transpiration from plants.
Daily Et = Monthly Et divided by the number of days in the associated month.
Application Rate = Inches per hour of water being applied.
This can be calculated by using Formula 1.2 or by referencing the Application Rate Charts on page 7.
60 minutes = Conversion factor from hours to minutes (60 minutes in one hour).

Note: Evapotranspiration rates for your geographic location can be found by searching the internet for local weather stations, from weather data services, from on-site weather collection devices, or from Historical Et data. If you are not irrigating daily, the Daily Et should be multiplied by the number of days since your prior irrigation cycle in order to replace the total Et since your previous irrigation cycle. If the Estimated Run Time is long enough to create water run-off, the total run time should be broken into multiple irrigation cycles. Cycle run time should not generate water run-off.

APPLICATION RATES

Techline® CV, CV XR, DL, RW, RWP and EZ DRIPLINES

APPLICATION RATE 0.26 GPH EMITTER

FLOW RATE (GPH)	EMITTER SPACING (IN.)	LATERAL SPACING (IN.)	APPLICATION RATE (IN./HR.)	TIME TO APPLY 1/4" (MIN.)
0.26	12	12	0.42	36
0.26	12	14	0.36	42
0.26	12	16	0.31	48
0.26	12	18	0.28	54
0.26	12	20	0.25	60
0.26	12	22	0.23	66
0.26	12	24	0.21	72
0.26	18	12	0.28	54
0.26	18	14	0.24	63
0.26	18	16	0.21	72
0.26	18	18	0.19	81
0.26	18	20	0.17	90
0.26	18	22	0.15	99
0.26	18	24	0.14	108

APPLICATION RATE 0.42 GPH EMITTER

FLOW RATE (GPH)	EMITTER SPACING (IN.)	LATERAL SPACING (IN.)	APPLICATION RATE (IN./HR.)	TIME TO APPLY 1/4" (MIN.)
0.42	12	12	0.64	23
0.42	12	14	0.55	27
0.42	12	16	0.48	31
0.42	12	18	0.43	35
0.42	12	20	0.39	39
0.42	12	22	0.35	43
0.42	12	24	0.32	47
0.42	18	12	0.43	35
0.42	18	14	0.37	41
0.42	18	16	0.32	47
0.42	18	18	0.29	53
0.42	18	20	0.26	58
0.42	18	22	0.23	64
0.42	18	24	0.21	70

APPLICATION RATE 0.61 GPH EMITTER

FLOW RATE (GPH)	EMITTER SPACING (IN.)	LATERAL SPACING (IN.)	APPLICATION RATE (IN./HR.)	TIME TO APPLY 1/4" (MIN.)
0.61	12	12	0.96	16
0.61	12	14	0.83	18
0.61	12	16	0.72	21
0.61	12	18	0.64	23
0.61	12	20	0.58	26
0.61	12	22	0.53	29
0.61	12	24	0.48	31
0.61	18	12	0.64	23
0.61	18	14	0.55	27
0.61	18	16	0.48	31
0.61	18	18	0.43	35
0.61	18	20	0.39	39
0.61	18	22	0.35	43
0.61	18	24	0.32	47
0.61	24	12	0.48	31
0.61	24	14	0.41	36
0.61	24	16	0.36	42
0.61	24	18	0.32	47
0.61	24	20	0.29	52
0.61	24	22	0.26	57
0.61	24	24	0.24	62

APPLICATION RATE 0.92 GPH EMITTER

FLOW RATE (GPH)	EMITTER SPACING (IN.)	LATERAL SPACING (IN.)	APPLICATION RATE (IN./HR.)	TIME TO APPLY 1/4" (MIN.)
0.92	12	12	1.44	10
0.92	12	14	1.24	12
0.92	12	16	1.08	14
0.92	12	18	0.96	16
0.92	12	20	0.87	17
0.92	12	22	0.79	19
0.92	12	24	0.72	21
0.92	18	12	0.96	16
0.92	18	14	0.83	18
0.92	18	16	0.72	21
0.92	18	18	0.64	23
0.92	18	20	0.58	26
0.92	18	22	0.53	29
0.92	18	24	0.48	31
0.92	24	12	0.72	21
0.92	24	14	0.62	24
0.92	24	16	0.54	28
0.92	24	18	0.48	31
0.92	24	20	0.43	35
0.92	24	22	0.39	38
0.92	24	24	0.36	42

Application Rate = (231.1 x GPH) / (Emitter Spacing x Lateral Spacing)

APPLICATION RATES

Techline® Copper, HCVXR-RW/RWP DRIPLINES

APPLICATION RATES 0.33 GPH EMITTER

FLOW RATE (GPH)	EMITTER SPACING (IN.)	LATERAL SPACING (IN.)	APPLICATION RATE (IN./HR.)	TIME TO APPLY 1/4" (MIN.)
0.33	12	12	0.53	28
0.33	12	14	0.45	33
0.33	12	16	0.40	38
0.33	12	18	0.35	42
0.33	12	20	0.32	47
0.33	12	22	0.29	52
0.33	12	24	0.26	57
0.33	18	12	0.35	42
0.33	18	14	0.30	50
0.33	18	16	0.26	57
0.33	18	18	0.24	64
0.33	18	20	0.21	71
0.33	18	22	0.19	78
0.33	18	24	0.18	85
0.33	24	12	0.26	57
0.33	24	14	0.23	66
0.33	24	16	0.20	76
0.33	24	18	0.18	85
0.33	24	20	0.16	94
0.33	24	22	0.14	104
0.33	24	24	0.13	113

APPLICATION RATES 0.53 GPH EMITTER

FLOW RATE (GPH)	EMITTER SPACING (IN.)	LATERAL SPACING (IN.)	APPLICATION RATE (IN./HR.)	TIME TO APPLY 1/4" (MIN.)
0.53	12	12	0.85	18
0.53	12	14	0.73	21
0.53	12	16	0.64	24
0.53	12	18	0.56	27
0.53	12	20	0.51	30
0.53	12	22	0.46	32
0.53	12	24	0.42	35
0.53	18	12	0.56	27
0.53	18	14	0.48	31
0.53	18	16	0.42	35
0.53	18	18	0.38	40
0.53	18	20	0.34	44
0.53	18	22	0.31	49
0.53	18	24	0.28	53
0.53	24	12	0.42	35
0.53	24	14	0.36	41
0.53	24	16	0.32	47
0.53	24	18	0.28	53
0.53	24	20	0.25	59
0.53	24	22	0.24	65
0.53	24	24	0.21	71

APPLICATION RATES 0.77 GPH EMITTER

FLOW RATE (GPH)	EMITTER SPACING (IN.)	LATERAL SPACING (IN.)	APPLICATION RATE (IN./HR.)	TIME TO APPLY 1/4" (MIN.)
0.77	12	12	1.23	12
0.77	12	14	1.05	14
0.77	12	16	0.92	16
0.77	12	18	0.82	18
0.77	12	20	0.74	20
0.77	12	22	0.67	22
0.77	12	24	0.61	24
0.77	18	12	0.82	18
0.77	18	14	0.70	21
0.77	18	16	0.61	24
0.77	18	18	0.55	27
0.77	18	20	0.49	31
0.77	18	22	0.45	34
0.77	18	24	0.41	37
0.77	24	12	0.61	24
0.77	24	14	0.53	28
0.77	24	16	0.46	33
0.77	24	18	0.41	37
0.77	24	20	0.37	41
0.77	24	22	0.34	45
0.77	24	24	0.31	49

Application Rate = (231.1 x GPH) / (Emitter Spacing x Lateral Spacing)

FRICION LOSS

Polyethylene (PE) Tubing

FRICION LOSS CHARACTERISTICS POLYETHYLENE (PE) SDR PRESSURE RATED PIPE (2306, 3206, 3306) SDR 7, 9, 11.5, 15, C=150, Sizes ½" to 6", Flows 1 to 900 GPM

PSI LOSS OF 100 FEET OF PIPE (PSI PER 100 FEET)

SIZE I.D.		½" 0.622"		¾" 0.824"		1" 1.049"		1 ¼" 1.380"		1 ½" 1.610"		2" 2.067"		2 ½" 2.469"		3" 3.068"		4" 4.026"		6" 6.065"	
Flow GPM	Flow GPH	Velocity FPS	PSI Loss	Velocity FPS	PSI Loss	Velocity FPS	PSI Loss	Velocity FPS	PSI Loss	Velocity FPS	PSI Loss	Velocity FPS	PSI Loss	Velocity FPS	PSI Loss	Velocity FPS	PSI Loss	Velocity FPS	PSI Loss	Velocity FPS	PSI Loss
1	60	1.06	0.49	0.60	0.12	0.37	0.04	0.21	0.01	0.16	0.00	0.10	0.00	0.07	0.00	0.04	0.00	0.03	0.00	0.01	0.00
2	120	2.11	1.76	1.20	0.45	0.74	0.14	0.43	0.04	0.32	0.02	0.19	0.01	0.13	0.00	0.09	0.00	0.05	0.00	0.02	0.00
3	180	3.17	3.73	1.80	0.95	1.11	0.29	0.64	0.08	0.47	0.04	0.29	0.01	0.20	0.00	0.13	0.00	0.08	0.00	0.03	0.00
4	240	4.22	6.35	2.41	1.62	1.48	0.50	0.86	0.13	0.63	0.06	0.38	0.02	0.27	0.01	0.17	0.00	0.10	0.00	0.04	0.00
5	300	5.28	9.60	3.01	2.44	1.86	0.76	1.07	0.20	0.79	0.09	0.48	0.03	0.34	0.01	0.22	0.00	0.13	0.00	0.06	0.00
6	360	6.34	13.46	3.61	3.43	2.23	1.06	1.29	0.28	0.95	0.13	0.57	0.04	0.40	0.02	0.26	0.01	0.15	0.00	0.07	0.00
7	420	7.39	17.91	4.21	4.56	2.60	1.41	1.50	0.37	1.10	0.18	0.67	0.05	0.47	0.02	0.30	0.01	0.18	0.00	0.08	0.00
8	480	8.45	22.93	4.81	5.84	2.97	1.80	1.72	0.47	1.26	0.22	0.76	0.07	0.54	0.03	0.35	0.01	0.20	0.00	0.09	0.00
9	540	9.50	28.52	5.41	7.26	3.34	2.24	1.93	0.59	1.42	0.28	0.86	0.08	0.60	0.03	0.39	0.01	0.23	0.00	0.10	0.00
10	600	10.56	34.67	6.02	8.82	3.71	2.73	2.15	0.72	1.58	0.34	0.96	0.10	0.67	0.04	0.43	0.01	0.25	0.00	0.11	0.00
11	660	11.61	41.36	6.62	10.53	4.08	3.25	2.36	0.86	1.73	0.40	1.05	0.12	0.74	0.05	0.48	0.02	0.28	0.00	0.12	0.00
12	720	12.67	48.60	7.22	12.37	4.45	3.82	2.57	1.01	1.89	0.48	1.15	0.14	0.80	0.06	0.52	0.02	0.30	0.01	0.13	0.00
14	840			8.42	16.45	5.20	5.08	3.00	1.34	2.21	0.63	1.34	0.19	0.94	0.08	0.61	0.03	0.35	0.01	0.16	0.00
16	960			9.63	21.07	5.94	6.51	3.43	1.71	2.52	0.81	1.53	0.24	1.07	0.10	0.69	0.04	0.40	0.01	0.18	0.00
18	1,080			10.83	26.21	6.68	8.10	3.86	2.13	2.84	1.01	1.72	0.30	1.21	0.13	0.78	0.04	0.45	0.01	0.20	0.00
20	1,200			12.03	31.85	7.42	9.84	4.29	2.59	3.15	1.22	1.91	0.36	1.34	0.15	0.87	0.05	0.50	0.01	0.22	0.00
22	1,320			13.24	38.00	8.17	11.74	4.72	3.09	3.47	1.46	2.10	0.43	1.47	0.18	0.95	0.06	0.55	0.02	0.24	0.00
24	1,440					8.91	13.79	5.15	3.63	3.78	1.72	2.29	0.51	1.61	0.21	1.04	0.07	0.60	0.02	0.27	0.00
26	1,560					9.65	16.00	5.58	4.21	4.10	1.99	2.49	0.59	1.74	0.25	1.13	0.09	0.66	0.02	0.29	0.00
28	1,680					10.39	18.35	6.01	4.83	4.41	2.28	2.68	0.68	1.88	0.28	1.22	0.10	0.71	0.03	0.31	0.00
30	1,800					11.14	20.85	6.44	5.49	4.73	2.59	2.87	0.77	2.01	0.32	1.30	0.11	0.76	0.03	0.33	0.00
35	2,100					12.99	27.74	7.51	7.30	5.52	3.45	3.35	1.02	2.35	0.43	1.52	0.15	0.88	0.04	0.39	0.01
40	2,400					8.58	9.35	6.30	4.42	3.82	1.31	2.68	0.55	1.74	0.19	1.01	0.05	0.44	0.01	0.05	0.00
45	2,700					9.65	11.63	7.09	5.49	4.30	1.63	3.02	0.69	1.95	0.24	1.13	0.06	0.50	0.01	0.06	0.00
50	3,000					10.73	14.14	7.88	6.68	4.78	1.98	3.35	0.83	2.17	0.29	1.26	0.08	0.56	0.01	0.06	0.00
55	3,300					11.80	16.87	8.67	7.97	5.26	2.36	3.69	0.99	2.39	0.35	1.39	0.09	0.61	0.01	0.06	0.00
60	3,600					12.87	19.82	9.46	9.36	5.74	2.77	4.02	1.17	2.60	0.41	1.51	0.11	0.67	0.01	0.06	0.00
65	3,900					13.94	22.98	10.24	10.86	6.21	3.22	4.36	1.36	2.82	0.47	1.64	0.13	0.72	0.02	0.06	0.00
70	4,200					11.03	12.45	6.69	3.69	4.69	1.55	3.04	0.54	1.76	0.14	1.78	0.02	0.06	0.00	0.06	0.00
75	4,500					11.82	14.15	7.17	4.19	5.03	1.77	3.25	0.61	1.89	0.16	1.89	0.16	0.83	0.02	0.06	0.00
80	4,800					12.61	15.95	7.65	4.73	5.36	1.99	3.47	0.69	2.02	0.18	2.02	0.18	0.89	0.03	0.06	0.00
85	5,100					13.40	17.84	8.13	5.29	5.70	2.23	3.69	0.77	2.14	0.21	0.94	0.03	0.06	0.00	0.06	0.00
90	5,400									8.61	5.88	6.03	2.48	3.91	0.86	2.27	0.23	1.00	0.03	0.06	0.00
95	5,700									9.08	6.50	6.37	2.74	4.12	0.95	2.39	0.25	1.06	0.03	0.06	0.00
100	6,000									9.56	7.15	6.70	3.01	4.34	1.05	2.52	0.28	1.11	0.04	0.06	0.00
110	6,600									10.52	8.53	7.37	3.59	4.77	1.25	2.77	0.33	1.22	0.05	0.06	0.00
120	7,200									11.47	10.02	8.04	4.22	5.21	1.47	3.02	0.39	1.33	0.05	0.06	0.00
130	7,800									12.43	11.62	8.71	4.89	5.64	1.70	3.28	0.45	1.44	0.06	0.06	0.00
140	8,400									13.39	13.33	9.38	5.61	6.08	1.95	3.53	0.52	1.55	0.07	0.06	0.00
150	9,000											10.05	6.38	6.51	2.22	3.78	0.59	1.67	0.08	0.06	0.00
160	9,600											10.72	7.19	6.94	2.50	4.03	0.67	1.78	0.09	0.06	0.00
170	10,200											11.39	8.04	7.38	2.79	4.28	0.74	1.89	0.10	0.06	0.00
180	10,800											12.06	8.94	7.81	3.11	4.54	0.83	2.00	0.11	0.06	0.00
190	11,400											12.73	9.88	8.25	3.43	4.79	0.92	2.11	0.12	0.06	0.00
200	12,000											13.40	10.87	8.68	3.78	5.04	1.01	2.22	0.14	0.06	0.00
225	13,500													9.76	4.70	5.67	1.25	2.50	0.17	0.06	0.00
250	15,000													10.85	5.71	6.30	1.52	2.78	0.21	0.06	0.00
275	16,500													11.93	6.81	6.93	1.81	3.05	0.25	0.06	0.00
300	18,000													13.02	8.00	7.56	2.13	3.33	0.29	0.06	0.00
325	19,500															8.19	2.47	3.61	0.34	0.06	0.00
350	21,000															8.82	2.84	3.89	0.39	0.06	0.00
375	22,500															9.45	3.22	4.16	0.44	0.06	0.00
400	24,000															10.08	3.63	4.44	0.49	0.06	0.00
425	25,500															10.71	4.06	4.72	0.55	0.06	0.00
450	27,000															11.34	4.52	5.00	0.62	0.06	0.00
475	28,500															11.97	4.99	5.28	0.68	0.06	0.00
500	30,000															12.60	5.49	5.55	0.75	0.06	0.00
550	33,000															13.86	6.55	6.11	0.89	0.06	0.00
600	36,000																	6.66	1.05	0.06	0.00
650	39,000																	7.22	1.22	0.06	0.00
700	42,000																	7.77	1.39	0.06	0.00
750	45,000																	8.33	1.58	0.06	0.00
800	48,000																	8.88	1.79	0.06	0.00
850	51,000																	9.44	2.00	0.06	0.00
900	54,000																	9.99	2.22	0.06	0.00

Note: Shaded areas of the chart indicate velocities over 5 Ft/Sec. Use with Caution.

Velocities are calculated using the general equation:
 $V = (0.4085 * (Q / d^2))$

Friction Losses are calculated using the Hazen-Williams Equation: $H_f = 0.2083 * (100 / C)^{1.852} * (Q^{1.852} / d^{4.866})$

V = FPS (feet per second)
H_f = PSI/100 Ft. (pounds per square inch per 100 feet)
C = 150
Q = GPM (gallons per minute)
d = ID (inside diameter)

FRICTION LOSS

Schedule 40 Pipe

FRICTION LOSS CHARACTERISTICS PVC SCHEDULE 40 IPS PLASTIC PIPE (1120, 1220), C=150, Sizes ½" to 6", Flows 1 to 900 GPM

PSI LOSS OF 100 FEET OF PIPE (PSI PER 100 FEET)

SIZE		½"		¾"		1"		1 ¼"		1 ½"		2"		2 ½"		3"		4"		6"																																																																																																																																																																																																																																																																																																																																																																																																																																																																																																																																																																																																																																																																																																																																																																																																																																																																																																																																																																																																																																																																																																																																																																															
I.D.		0.622"		0.824"		1.049"		1.380"		1.610"		2.067"		2.469"		3.068"		4.026"		6.065"																																																																																																																																																																																																																																																																																																																																																																																																																																																																																																																																																																																																																																																																																																																																																																																																																																																																																																																																																																																																																																																																																																																																																																															
O.D.		0.840"		1.050"		1.315"		1.660"		1.900"		2.375"		2.875"		3.500"		4.500"		6.625"																																																																																																																																																																																																																																																																																																																																																																																																																																																																																																																																																																																																																																																																																																																																																																																																																																																																																																																																																																																																																																																																																																																																																																															
WALL		0.109"		0.113"		0.133"		0.140"		0.145"		0.154"		0.203"		0.216"		0.237"		0.280"																																																																																																																																																																																																																																																																																																																																																																																																																																																																																																																																																																																																																																																																																																																																																																																																																																																																																																																																																																																																																																																																																																																																																																															
Flow GPM	Flow GPH	Velocity FPS	PSI Loss	Velocity FPS	PSI Loss	Velocity FPS	PSI Loss	Velocity FPS	PSI Loss	Velocity FPS	PSI Loss	Velocity FPS	PSI Loss	Velocity FPS	PSI Loss	Velocity FPS	PSI Loss	Velocity FPS	PSI Loss	Velocity FPS	PSI Loss																																																																																																																																																																																																																																																																																																																																																																																																																																																																																																																																																																																																																																																																																																																																																																																																																																																																																																																																																																																																																																																																																																																																																																														
																						1	2	3	4	5	6	7	8	9	10	11	12	14	16	18	20	22	24	26	28	30	35	40	45	50	55	60	65	70	75	80	85	90	95	100	110	120	130	140	150	160	170	180	190	200	225	250	275	300	325	350	375	400	425	450	475	500	550	600	650	700	750	800	850	900																																																																																																																																																																																																																																																																																																																																																																																																																																																																																																																																																																																																																																																																																																																																																																																																																																																																																																																																																																																																																																																																																																													
1.06	0.43	0.60	0.11	0.37	0.03	0.21	0.01	0.16	0.00	0.10	0.00	0.07	0.00	0.04	0.00	0.03	0.00	0.01	0.00	0.01	0.00																																																																		0.120	2.11	1.55	1.20	0.39	0.74	0.12	0.43	0.03	0.32	0.02	0.19	0.00	0.13	0.00	0.09	0.00	0.05	0.00	0.02	0.00	3.17	3.28	1.80	0.84	1.11	0.26	0.64	0.07	0.47	0.03	0.29	0.01	0.20	0.00	0.13	0.00	0.08	0.00	0.03	0.00	4.22	5.59	2.41	1.42	1.48	0.44	0.86	0.12	0.63	0.05	0.38	0.02	0.27	0.01	0.17	0.00	0.10	0.00	0.04	0.00	5.28	8.45	3.01	2.15	1.86	0.66	1.07	0.17	0.79	0.08	0.48	0.02	0.34	0.01	0.22	0.00	0.13	0.00	0.06	0.00	6.34	11.85	3.61	3.02	2.23	0.93	1.29	0.25	0.95	0.12	0.57	0.03	0.40	0.01	0.26	0.01	0.15	0.00	0.07	0.00	7.39	15.76	4.21	4.01	2.60	1.24	1.50	0.33	1.10	0.15	0.67	0.05	0.47	0.02	0.30	0.01	0.18	0.00	0.08	0.00	8.45	20.18	4.81	5.14	2.97	1.59	1.72	0.42	1.26	0.20	0.76	0.06	0.54	0.02	0.35	0.01	0.20	0.00	0.09	0.00	9.50	25.10	5.41	6.39	3.34	1.97	1.93	0.52	1.42	0.25	0.86	0.07	0.60	0.03	0.39	0.01	0.23	0.00	0.10	0.00	10.60	30.51	6.02	7.77	3.71	2.40	2.15	0.63	1.58	0.30	0.96	0.09	0.67	0.04	0.43	0.01	0.25	0.00	0.11	0.00	11.61	36.40	6.62	9.26	4.08	2.86	2.36	0.75	1.73	0.36	1.05	0.11	0.74	0.04	0.48	0.02	0.28	0.00	0.12	0.00	12.67	42.77	7.22	10.88	4.45	3.36	2.57	0.89	1.89	0.42	1.15	0.12	0.80	0.05	0.52	0.02	0.30	0.00	0.13	0.00	14.840		8.42	14.48	5.20	4.47	3.00	1.18	2.21	0.56	1.34	0.16	0.94	0.07	0.61	0.02	0.35	0.01	0.16	0.00	16.960		9.63	18.54	5.94	5.73	3.43	1.51	2.52	0.71	1.53	0.21	1.07	0.09	0.69	0.03	0.40	0.01	0.18	0.00	18.1080		10.83	23.06	6.68	7.12	3.86	1.88	2.84	0.89	1.72	0.26	1.21	0.11	0.78	0.04	0.45	0.01	0.20	0.00	20.1200		12.03	28.03	7.42	8.66	4.29	2.28	3.15	1.08	1.91	0.32	1.34	0.13	0.87	0.05	0.50	0.01	0.22	0.00	22.1320		13.24	33.44	8.17	10.33	4.72	2.72	3.47	1.28	2.10	0.38	1.47	0.16	0.95	0.06	0.55	0.01	0.24	0.00	24.1440		8.91	12.14	5.15	3.20	3.78	1.51	2.29	0.45	1.61	0.19	1.04	0.07	0.60	0.02	0.27	0.00	26.1560		9.65	14.08	5.58	3.71	4.10	1.75	2.49	0.52	1.74	0.22	1.13	0.08	0.66	0.02	0.29	0.00	28.1680		10.39	16.15	6.01	4.25	4.41	2.01	2.68	0.60	1.88	0.25	1.22	0.09	0.71	0.02	0.31	0.00	30.1800		11.14	18.35	6.44	4.83	4.73	2.28	2.87	0.68	2.01	0.28	1.30	0.10	0.76	0.03	0.33	0.00	35.2100		12.99	24.41	7.51	6.43	5.52	3.04	3.35	0.90	2.35	0.38	1.52	0.13	0.88	0.04	0.39	0.00	40.2400			8.58	8.23	6.30	3.89	3.82	1.15	2.68	0.49	1.74	0.17	1.01	0.04	0.44	0.01	45.2700			9.65	10.24	7.09	4.83	4.30	1.43	3.02	0.60	1.95	0.21	1.13	0.06	0.50	0.01	50.3000			10.73	12.44	7.88	5.88	4.78	1.74	3.35	0.73	2.17	0.25	1.26	0.07	0.56	0.01	55.3300			11.80	14.84	8.67	7.01	5.26	2.08	3.69	0.88	2.39	0.30	1.39	0.08	0.61	0.01	60.3600			12.87	17.44	9.46	8.24	5.74	2.44	4.02	1.03	2.60	0.36	1.51	0.10	0.67	0.01	65.3900			13.94	20.23	10.24	9.55	6.21	2.83	4.36	1.19	2.82	0.41	1.64	0.11	0.72	0.02	70.4200					11.03	10.96	6.69	3.25	4.69	1.37	3.04	0.48	1.76	0.13	1.78	0.02	75.4500					11.82	12.45	7.17	3.69	5.03	1.55	3.25	0.54	1.89	0.14	1.89	0.02	80.4800					12.61	14.03	7.65	4.16	5.36	1.75	3.47	0.61	2.02	0.16	2.02	0.02	85.5100					13.40	15.70	8.13	4.65	5.70	1.96	3.69	0.68	2.14	0.18	2.14	0.04	90.5400									8.61	5.17	6.03	2.18	3.91	0.76	2.27	0.20	1.00	0.03	95.5700									9.08	5.72	6.37	2.41	4.12	0.84	2.39	0.22	1.06	0.03	100.6000									9.56	6.29	6.70	2.65	4.34	0.92	2.52	0.25	1.11	0.03	110.6600									10.52	7.50	7.37	3.16	4.77	1.10	2.77	0.29	1.22	0.04	120.7200									11.47	8.82	8.04	3.71	5.21	1.29	3.02	0.34	1.33	0.05	130.7800									12.43	10.22	8.71	4.31	5.64	1.50	3.28	0.40	1.44	0.05	140.8400									13.39	11.73	9.38	4.94	6.08	1.72	3.53	0.46	1.55	0.06	150.9000									10.05	5.61	6.51	1.95	3.78	0.52	1.67	0.07	160.9600									10.72	6.33	6.94	2.20	4.03	0.59	1.78	0.08	170.10200									11.39	7.08	7.38	2.46	4.28	0.66	1.89	0.09	180.10800									12.06	7.87	7.81	2.73	4.54	0.73	2.00	0.10	190.11400									12.73	8.70	8.25	3.02	4.79	0.81	2.11	0.11	200.12000									13.40	9.56	8.68	3.32	5.04	0.89	2.22	0.12	225.13500											9.76	4.13	5.67	1.10	2.50	0.15	250.15000											10.85	5.02	6.30	1.34	2.78	0.18	275.16500											11.93	5.99	6.93	1.60	3.05	0.22	300.18000											13.02	7.04	7.56	1.88	3.33	0.26	325.19500												8.19	2.18	3.61	0.30	350.21000												8.82	2.50	3.89	0.34	375.22500												9.45	2.84	4.16	0.39	400.24000												10.08	3.20	4.44	0.44	425.25500												10.71	3.58	4.72	0.49	450.27000												11.34	3.98	5.00	0.54	475.28500												11.97	4.40	5.28	0.60	500.30000												12.60	4.83	5.55	0.66	550.33000												13.86	5.77	6.11	0.79	600.36000														6.66	0.92	650.39000													7.22	1.07	700.42000									

Note: Shaded areas of the chart indicate velocities over 5 Ft/Sec. Use with Caution.

Velocities are calculated using the general equation:
 $V = (0.4085 * (Q / d^2))$

Friction Losses are calculated using the Hazen-Williams Equation: $H_f = 0.2083 * (100 / C)^{1.852} * (Q^{1.852} / d^{4.866})$

V = FPS (feet per second)

H_f = PSI/100 Ft. (pounds per square inch per 100 feet)

C = 150

Q = GPM (gallons per minute)

d = ID (inside diameter)

FRICION LOSS

PVC Class 40

FRICION LOSS CHARACTERISTICS PVC CLASS 200 IPS PLASTIC PIPE (1120, 1220) SDR 21, C=150, Sizes ½" to 6", Flows 1 to 900 GPM

PSI LOSS OF 100 FEET OF PIPE (PSI PER 100 FEET)

SIZE		½" (Class 315)		¾"		1"		1 ¼"		1 ½"		2"		2 ½"		3"		4"		6"	
I.D.		0.716"		0.930"		1.189"		1.502"		1.720"		2.149"		2.601"		3.166"		4.072"		5.993"	
O.D.		0.840"		1.050"		1.315"		1.660"		1.900"		2.375"		2.875"		3.500"		4.500"		6.625"	
WALL		0.062"		0.060"		0.063"		0.079"		0.090"		0.113"		0.137"		0.167"		0.214"		0.316"	
Flow GPM	Flow GPH	Velocity FPS	PSI Loss	Velocity FPS	PSI Loss	Velocity FPS	PSI Loss	Velocity FPS	PSI Loss	Velocity FPS	PSI Loss	Velocity FPS	PSI Loss	Velocity FPS	PSI Loss	Velocity FPS	PSI Loss	Velocity FPS	PSI Loss	Velocity FPS	PSI Loss
1	60	0.80	0.22	0.47	0.06	0.29	0.02	0.18	0.01	0.14	0.00	0.09	0.00	0.06	0.00	0.04	0.00	0.02	0.00	0.01	0.00
2	120	1.59	0.78	0.94	0.22	0.58	0.07	0.36	0.02	0.28	0.01	0.18	0.00	0.12	0.00	0.08	0.00	0.05	0.00	0.02	0.00
3	180	2.39	1.65	1.42	0.46	0.87	0.14	0.54	0.04	0.41	0.02	0.27	0.01	0.18	0.00	0.12	0.00	0.07	0.00	0.03	0.00
4	240	3.19	2.82	1.89	0.79	1.16	0.24	0.72	0.08	0.55	0.04	0.35	0.01	0.24	0.01	0.16	0.00	0.10	0.00	0.05	0.00
5	300	3.98	4.26	2.36	1.19	1.44	0.36	0.91	0.12	0.69	0.06	0.44	0.02	0.30	0.01	0.20	0.00	0.12	0.00	0.06	0.00
6	360	4.78	5.97	2.83	1.67	1.73	0.51	1.09	0.16	0.83	0.08	0.53	0.03	0.36	0.01	0.24	0.00	0.15	0.00	0.07	0.00
7	420	5.58	7.95	3.31	2.23	2.02	0.67	1.27	0.22	0.97	0.11	0.62	0.04	0.42	0.01	0.29	0.01	0.17	0.00	0.08	0.00
8	480	6.37	10.18	3.78	2.85	2.31	0.86	1.45	0.28	1.10	0.14	0.71	0.05	0.48	0.02	0.33	0.01	0.20	0.00	0.09	0.00
9	540	7.17	12.66	4.25	3.55	2.60	1.07	1.63	0.34	1.24	0.18	0.80	0.06	0.54	0.02	0.37	0.01	0.22	0.00	0.10	0.00
10	600	7.97	15.38	4.72	4.31	2.89	1.30	1.81	0.42	1.38	0.22	0.88	0.07	0.60	0.03	0.41	0.01	0.25	0.00	0.11	0.00
11	660	8.77	18.35	5.20	5.14	3.18	1.56	1.99	0.50	1.52	0.26	0.97	0.09	0.66	0.03	0.45	0.01	0.27	0.00	0.13	0.00
12	720	9.56	21.56	5.67	6.04	3.47	1.83	2.17	0.59	1.66	0.30	1.06	0.10	0.72	0.04	0.49	0.02	0.30	0.00	0.14	0.00
14	840	11.16	28.69	6.61	8.04	4.05	2.43	2.54	0.78	1.93	0.40	1.24	0.14	0.85	0.05	0.57	0.02	0.34	0.01	0.16	0.00
16	960	12.75	36.73	7.56	10.29	4.62	3.11	2.90	1.00	2.21	0.52	1.42	0.17	0.97	0.07	0.65	0.03	0.39	0.01	0.18	0.00
18	1,080			8.50	12.80	5.20	3.87	3.26	1.24	2.49	0.64	1.59	0.22	1.09	0.09	0.73	0.03	0.44	0.01	0.20	0.00
20	1,200			9.45	15.56	5.78	4.71	3.62	1.51	2.76	0.78	1.77	0.26	1.21	0.10	0.82	0.04	0.49	0.01	0.23	0.00
22	1,320			10.39	18.56	6.36	5.62	3.98	1.80	3.04	0.93	1.95	0.32	1.33	0.12	0.90	0.05	0.54	0.01	0.25	0.00
24	1,440			11.34	21.81	6.93	6.60	4.35	2.12	3.31	1.09	2.12	0.37	1.45	0.15	0.98	0.06	0.59	0.02	0.27	0.00
26	1,560			12.28	25.29	7.51	7.65	4.71	2.45	3.59	1.27	2.30	0.43	1.57	0.17	1.06	0.07	0.64	0.02	0.30	0.00
28	1,680			13.22	29.01	8.09	8.78	5.07	2.82	3.87	1.46	2.48	0.49	1.69	0.19	1.14	0.07	0.69	0.02	0.32	0.00
30	1,800					8.67	9.97	5.43	3.20	4.14	1.65	2.65	0.56	1.81	0.22	1.22	0.08	0.74	0.02	0.34	0.00
35	2,100					10.11	13.27	6.34	4.26	4.83	2.20	3.10	0.74	2.11	0.29	1.43	0.11	0.86	0.03	0.40	0.01
40	2,400					11.56	16.99	7.24	5.45	5.52	2.82	3.54	0.95	2.42	0.38	1.63	0.14	0.99	0.04	0.45	0.01
45	2,700					13.00	21.13	8.15	6.78	6.21	3.51	3.98	1.19	2.72	0.47	1.83	0.18	1.11	0.05	0.51	0.01
50	3,000							9.05	8.24	6.90	4.26	4.42	1.44	3.02	0.57	2.04	0.22	1.23	0.06	0.57	0.01
55	3,300							9.96	9.83	7.59	5.08	4.86	1.72	3.32	0.68	2.24	0.26	1.35	0.08	0.63	0.01
60	3,600							10.86	11.55	8.28	5.97	5.31	2.02	3.62	0.80	2.45	0.31	1.48	0.09	0.68	0.01
65	3,900							11.77	13.39	8.98	6.93	5.75	2.34	3.92	0.93	2.65	0.36	1.60	0.10	0.74	0.02
70	4,200							12.68	15.36	9.67	7.95	6.19	2.69	4.23	1.06	2.85	0.41	1.72	0.12	0.80	0.02
75	4,500							13.58	17.46	10.36	9.03	6.63	3.05	4.53	1.21	3.06	0.46	1.85	0.14	0.85	0.02
80	4,800									11.05	10.17	7.08	3.44	4.83	1.36	3.26	0.52	1.97	0.15	0.91	0.02
85	5,100									11.74	11.38	7.52	3.85	5.13	1.52	3.46	0.58	2.09	0.17	0.97	0.03
90	5,400									12.43	12.65	7.96	4.28	5.43	1.69	3.67	0.65	2.22	0.19	1.02	0.03
95	5,700									13.12	13.99	8.40	4.73	5.74	1.87	3.87	0.72	2.34	0.21	1.08	0.03
100	6,000									13.81	15.38	8.85	5.20	6.04	2.06	4.08	0.79	2.46	0.23	1.14	0.04
110	6,600											9.73	6.21	6.64	2.45	4.48	0.94	2.71	0.28	1.25	0.04
120	7,200											10.61	7.30	7.25	2.88	4.89	1.11	2.96	0.33	1.36	0.05
130	7,800											11.50	8.46	7.85	3.34	5.30	1.28	3.20	0.38	1.48	0.06
140	8,400											12.38	9.71	8.45	3.83	5.71	1.47	3.45	0.43	1.59	0.07
150	9,000											13.27	11.03	9.06	4.36	6.11	1.67	3.70	0.49	1.71	0.08
160	9,600													9.66	4.91	6.52	1.89	3.94	0.55	1.82	0.08
170	10,200													10.27	5.49	6.93	2.11	4.19	0.62	1.93	0.09
180	10,800													10.87	6.11	7.34	2.35	4.43	0.69	2.05	0.11
190	11,400													11.47	6.75	7.74	2.59	4.68	0.76	2.16	0.12
200	12,000													12.08	7.42	8.15	2.85	4.93	0.84	2.27	0.13
225	13,500													13.59	9.23	9.17	3.55	5.54	1.04	2.56	0.16
250	15,000														10.19	4.31	6.16	1.27	2.84	0.19	
275	16,500														11.21	5.14	6.77	1.51	3.13	0.23	
300	18,000														12.23	6.04	7.39	1.78	3.41	0.27	
325	19,500														13.25	7.01	8.01	2.06	3.70	0.31	
350	21,000																8.62	2.36	3.98	0.36	
375	22,500																9.24	2.68	4.27	0.41	
400	24,000																9.85	3.03	4.55	0.46	
425	25,500																10.47	3.38	4.83	0.52	
450	27,000																11.09	3.76	5.12	0.57	
475	28,500																11.70	4.16	5.40	0.63	
500	30,000																12.32	4.57	5.69	0.70	
550	33,000																13.55	5.46	6.26	0.83	
600	36,000																		6.82	0.98	
650	39,000																			7.39	1.13
700	42,000																			7.96	1.30
750	45,000																			8.53	1.48
800	48,000																			9.10	1.67
850	51,000																			9.67	1.86
900	54,000																			10.24	2.07

Note: Shaded areas of the chart indicate velocities over 5 Ft/Sec. Use with Caution.

Velocities are calculated using the general equation:

$$V = (0.4085 * (Q / d^2))$$

Friction Losses are calculated using the Hazen-Williams Equation: $H_f = 0.2083 * (100 / C)^{1.852} * (Q^{1.852} / d^{4.866})$

V = FPS (feet per second)

H_f = PSI/100 Ft. (pounds per square inch per 100 feet)

C = 150

Q = GPM (gallons per minute)

d = ID (inside diameter)



TECHLINE® CALCULATOR APP

The Techline Calculator App gives you a quick and easy way to determine your landscape design needs from anywhere. Just plug in your application type, dripline placement, soil type, and size of project, and the calculator app provides you with all the information you need to specify the correct Techline dripline and Netafim Control Zone products.



Techline CV XR™

Pressure compensating (PC) in-line drip emitter with built in check valve. Same industry leading features as Techline CV now with Cupron injected directly into the emitters.

Benefits & Features

- **Cupron Enhanced Dripper**
Cupron Oxide is embedded into the emitter labyrinth and is an effective deterrent against root intrusion without any reliance on chemicals. Cupron Oxide also provides long lasting protection due to non-volatile active ingredients, lasting the life of the Techline.
- **Check Valve (CV)**
All emitters turn on and off at the same time, maximizing balance of application. Holds back up to 4.5 of water. No low emitter drainage, great on slopes, and delivers more precise watering.
- **Anti-Siphon Mechanism**
Prevents contaminants from being drawn into the dripper, making it ideal for subsurface applications.
- **Pressure Compensated**
Prevents and equal amounts of water delivered over a broad pressure range ensuring 100% uniformity of water and nutrient distribution along the lateral.
- **Physical Root Barrier**
Offset flow path, extra large ball area, and raised outlets provide another level of protection to physically blocking roots from the dripper.
- **Continuous Self-Flushing Mechanism**
Flushes debris throughout operation, while ensuring constant dripper operation.
- **Large Filtration Area**
The Techline™ CVXR Dripper is highly resistant to clogging from poor quality water, thus increasing filtration efficiency.
- **Turbulent™**
Turbulent technology improves dripper performance by widening the flow path, maximizing flow path velocity, allowing contaminants to pass easily through the dripper, thereby eliminating clogging.

NETAFIM www.netafimusa.com

TECHNICAL SHEETS

All the technical information you need about a Netafim product. The technical sheets and brochures give you the complete details about our products in a format that is easy to download and share.

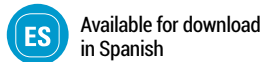

TECHLINE HCVXR AND CV DESIGN GUIDE

DRIPLINE FOR SUBSURFACE AND ON-SURFACE

DESIGN GUIDES

Netafim Product Design Guides walk you through the design process step by step. Includes important information about best practices and our recommendations.

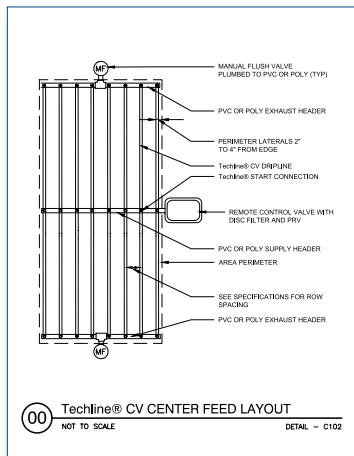

DESIGN DETAILS

Easy to download and use, our design details show line drawings of our products and their typical layouts in multiple file formats.

SOLUTIONS BY NETAFIM

INSPIRING LANDSCAPE MANAGEMENT PLAN SAVES WATER & REDUCES MAINTENANCE COSTS

LEED CERTIFIED PLAN CALLS FOR 20 MILES OF TECHLINE CV DRIPLINE

DESIGN SUMMARY
In Southern California, water usage charges are skyrocketing and water conservation is a top priority for many organizations. The goal was to create a sustainable landscape management plan that would reduce water consumption and maintenance costs while maintaining a high-quality, attractive outdoor environment.

DESIGN SOLUTIONS
The landscape design team selected Techline CV dripline for its proven performance and long life expectancy. The system was installed in a way that allowed for easy maintenance and replacement of individual emitters.

KEY BENEFITS
• Reduced water consumption and maintenance costs
• Increased landscape sustainability
• Improved water efficiency
• Reduced environmental impact

SOLUTIONS BY NETAFIM

Each Solution by Netafim highlights an actual installation of Netafim Landscape and Turf products. Learn how drip irrigation helped a corporate campus reduce water consumption over 70% or how a Colorado sports complex used subsurface drip irrigation to conserve water, minimize wind water loss and irrigate even when the fields were in use.



LEED® CERTIFICATION

Netafim supports the strategies of LEED for achieving a prosperous and sustainable future through cost-effective and energy-saving green buildings. Netafim products contribute to LEED credits for New Construction and Major Renovations.

WARRANTY INFORMATION

NETAFIM USA'S LIMITED WARRANTY/LIMITATION OF BUYER'S REMEDIES

BASIC MANUFACTURER'S LIMITED WARRANTY

Except as to products described in Subsections (B), (C), (D), (E) and (F), products sold and/or manufactured by Netafim Irrigation, Inc. (Netafim USA) are warranted to be free from original defects in material and workmanship for a period of one (1) year from the date of delivery to the buyer unless (a) otherwise specified by and subject to the terms and conditions of any Warranty Supplements pertaining to specific products or, (b) expressly disclaimed in writing by Netafim USA. Within the warranty period, Netafim USA at its sole discretion shall have the option to repair or replace part or all of a defective product, or refund part or all of the original purchase price, if any part proves to be defective in material or workmanship after return of such product at Buyer's expense and after such return has been authorized in writing by Netafim USA. THIS BASIC MANUFACTURER'S LIMITED WARRANTY IS SUBJECT TO THE TERMS AND PROVISIONS IN SUBSECTION (i), (LIMITATION OF REMEDIES AND DISCLAIMER OF WARRANTIES) SET FORTH BELOW IN THE EVENT OF ANY INCONSISTENCY BETWEEN SUBSECTION (A) AND SUBSECTION (i) OF THIS PRODUCT WARRANTY, THE PROVISIONS OF SUBSECTION (i) SHALL PREVAIL.

EMITTERS

Netafim on-line emitters are warranted to be free from original defects in materials and workmanship for a period of five (5) years from the date of shipment from Netafim.

NetBow is warranted to be free from original defects in materials and workmanship for a period of two (2) years from the date of shipment from Netafim.

DRIPLINES AND BLANK POLYETHYLENE TUBING

Netafim warrants any polyethylene tubing and driplines (Techline® Copper, HCVXR-RW, HCVXR-RWP, CV XR, CV, DL, RW, RWP and EZ) sold to be free from original defects in materials and workmanship for a period of seven (7) years and ten (10) years for environmental stress cracking - from the date of original delivery

FILTERS

Manual disc filters are warranted to be free from original defects in materials and workmanship for a period of one (1) year. Automatic disc filters are warranted to be free from original defects in materials and workmanship for a period of five (5) years. This warranty specifically excludes gaskets, diaphragms, seals, o-rings, solenoids and, PD gauges which are subject to the basic one (1) year warranty.

VALVES, WATER METERS AND HYDROMETERS

Valve, Water Meter and Hydrometer bodies are warranted to be free from original defects in materials and workmanship for a period of five (5) years. Water Meter and Hydrometer metering components (register, electrical output and metering assembly) are warranted for three (3) years. Valve and Hydrometer diaphragms are warranted for two (2) years. This warranty specifically excludes pilots, pilot accessories, relays, solenoids, solenoid component/ fittings, which are subject to the basic one (1) year warranty.

Octave Water Meters are warranted to be free from original defects in materials and workmanship for a period up to five (5) years. If the meter encounters a problem, Netafim USA will choose to cover the cost of repair or replacement based on a five (5) year pro-rated schedule as follows:

Year 0 through 2: 100% Year 2 through 3: 75%

Year 3 through 4: 50% Year 4 through 5: 25%

All Octave Water Meters must be installed with a Netafim branded Combination Air/Vacuum or Continuous Acting Air Vents to qualify for the five (5) year pro-rated product warranty.

ROOT INTRUSION

Netafim warrants Techline® Copper/ TLCV XR to be free of emitter plugging due to root intrusion for a period of seventeen (17) years from the date of original delivery.

Techline® Copper/ TLCV XR that has the additional protection of being part of a complete Netafim system made up of Netafim valves, filters, pressure regulators and fittings will be replaced at no cost if emitter plugging due to root intrusion occurs during the warranty period.

Year 0 through 17: 100%

Techline® Copper/ TLCV XR that is not part of a complete Netafim system will qualify for the special seventeen (17) year extended warranty, however the applicable buyer's remedy from date of purchase shall be limited to and pro-rated as follows:

Year 0 through 7: 100%

Year 8 through 11: 50%

Year 12 through 17: 25%

Warranty Conditions:

- Roots must be entering through emitter to qualify.
- Roots must be reducing flow below ISO 9261 low flow target tolerances to qualify.

LIMITATION OF REMEDIES AND DISCLAIMER OF WARRANTIES

EXCEPT AS EXPRESSLY PROVIDED HEREIN, ALL WARRANTIES EXPRESSED OR IMPLIED, INCLUDING ANY IMPLIED WARRANTY OF MERCHANTABILITY OR FITNESS FOR A PARTICULAR PURPOSE OR USE, ARE HEREBY EXCLUDED AND DISCLAIMED.

THE REMEDIES PROVIDED HEREIN SHALL BE THE EXCLUSIVE AND SOLE REMEDY OF THE BUYER. NO OTHER EXPRESS WARRANTY IS GIVEN AND NO AFFIRMATION BY NETAFIM USA, BY WORDS OR ACTION, WILL CONSTITUTE A WARRANTY. NO OTHER EXPRESS WARRANTY NOR ANY OTHER REMEDY SHALL BE AVAILABLE TO THE BUYER AND NETAFIM USA SHALL NOT BE RESPONSIBLE OR LIABLE FOR ANY DAMAGES, INCLUDING ANY LOSS OF PROFIT, LOST SAVINGS, LOSS OF SALES, OR OTHER DIRECT, INDIRECT, INCIDENTAL, SPECIAL OR CONSEQUENTIAL DAMAGES, INJURY OR DAMAGES TO ANY PERSON OR PROPERTY ARISING OUT OF THE USE OR INABILITY TO USE THE PRODUCTS OR THE BREACH OF ANY EXPRESS WARRANTY, EVEN IF NETAFIM USA HAS BEEN ADVISED OF THE POSSIBILITY OF THOSE DAMAGES OR CLAIMS. NETAFIM USA SHALL NOT BE RESPONSIBLE FOR THE AFORESAID DAMAGES, CLAIMS OR LOSSES DUE TO LATE DELIVERY OR DELIVERY OR NON-DELIVER, OR OTHERWISE. THERE ARE NO WARRANTIES WHICH EXTEND BEYOND THE DESCRIPTION AS SET FORTH HEREIN. IF NETAFIM USA SHALL FURNISH TECHNICAL ADVICE OR ASSISTANCE WITH RESPECT TO THE PRODUCTS SOLD HEREUNDER, IT SHALL BE GIVEN WITHOUT CHARGE TO BUYER AND SHALL BE GIVEN AND ACCEPTED AT BUYER'S SOLE RISK WITHOUT ANY EXPRESS OR IMPLIED WARRANTY AND NETAFIM USA SHALL NOT BE RESPONSIBLE OR LIABLE FOR THE ADVICE OR THE RESULTS THEREOF BUYER ASSUMES ALL RISK AND LIABILITY RESULTING FROM USE OF THE PRODUCT PURCHASED.

This warranty is expressly conditioned upon proper storage, installation, application, and normal agriculture use and service as recommended by Netafim USA. Such recommendations may be updated from time to time. Any misuse, neglect, modifications, unauthorized repairs, or replacement or uses of the product and/or any of its components for nonagriculture purposes not recommended by Netafim USA, including but not limited to the following, shall completely void this warranty:

(I) Irrigation water which has not been filtered or treated to the levels specified for individual components of the product by Netafim.
(II) Chemical concentrates, used or applied internally or externally to the product, or mechanical abuse which is harmful to the product or its components.

(III) Operating pressures greater than those specified by Netafim's individual component specifications.

(IV) Damage or plugging caused by insects, rodents, other animals, improper installation, or other mechanical damage. THE EXPRESS WARRANTY PROVIDED HEREIN IS EFFECTIVE ONLY IF CLAIM IS MADE BY WRITTEN NOTICE WITHIN THE APPLICABLE WARRANTY PERIOD AND POSTMARKED WITHIN THIRTY (30) DAYS AFTER DISCOVERY OF THE DEFECT ON WHICH THE CLAIM IS BASED. SUCH NOTICE SHALL BE DELIVERED TO NETAFIM USA AT THE FOLLOWING ADDRESS: NETAFIM USA ATTN: PRODUCT MANAGEMENT 5470 EAST HOME AVENUE FRESNO, CA 93727

The buyer shall, together with its notice of claim, offer Netafim USA in writing prompt opportunity to examine the defective product and correct the defect, if possible. This warranty shall be void unless buyer delivers the defective product to Netafim USA at buyer's sole cost and in accordance with Netafim USA's instructions.

WARRANTY INFORMATION

PRODUCT WARRANTIES

PRODUCT DESCRIPTION	WARRANTY LENGTH
AIR VENTS	
Nylon Bodies	5 Years
Polypropylene Bodies	2 Years
Gaskets, Seals, O-Rings	1 Year
DISC FILTERS	
Gaskets, Seals, O-Rings	1 Year
DRIPPERS	
NetBow	2 Years
WATER METERS	
Metering Component	5 Years
Bodies	5 Years
Octave (Pro-Rated Schedule Applies)	
HEAVYWALL DRIPLINES	
Manufacturer's Defects	7 Years
Uniram, Uniram XRS, Aries, DripNet PC	
Environmental Stress Cracking (35 mil/greater)	10 Years
Uniram, Uniram XRS, Aries, DripNet PC	1 Year
HEAVYWALL FITTINGS	
SPRINKLERS & SPRAY JETS	
(Pro-Rated Schedule Applies)	5 Years
Sprinkler Components	1 Year
MegaNet	5 Years
STEEL SAND MEDIA FILTERS (Body Only)	
Sand Media Filter Component	5 Years
STEEL SCREEN FILTERS (Body Only)	
Screen Filter Component	1 Year
SCAN-KLEEN SCREEN FILTERS	
POLYETHYLENE TUBING	
Manufacturer's Defects	10 Years
Environmental Stress Cracking (35 mil/greater)	3 Years
FLEXNET FLEXIBLE PIPE	
OVAL TUBE	
42 psi pro-rated	2 Years
21 or 29 psi pro-rated	1 Year
PRESSURE REGULATORS	
THINWALL DRIPLINES	
5, 6 or 8 mil Streamline X 630/875	1 Year
8 mil Typhoon Plus (all)	2 Years
10 mil Streamline X 630/875	2 Years
10, 13 or 15 mil Typhoon Plus 630/875	2 Years
13 or 15 mil Aries 638/875	2 Years
13 or 15 mil Aries and Typhoon Plus 990	2 Years
Aries and Typhoon Plus 1 1/8 and 1 3/8	2 Years
DripNet PC	1 Year
Splicer	1 Year
THINWALL FITTINGS	
VALVES	
Bodies	2 Years
Diaphragms	1 Year



An Orbia business.

NETAFIM USA

**5470 E. HOME AVE
FRESNO, CA 93727**

**(888) NETAFIM | (888) 638.2346
NETAFIMUSA.COM**